

# Monitor Multiparamétrico EDAN M8

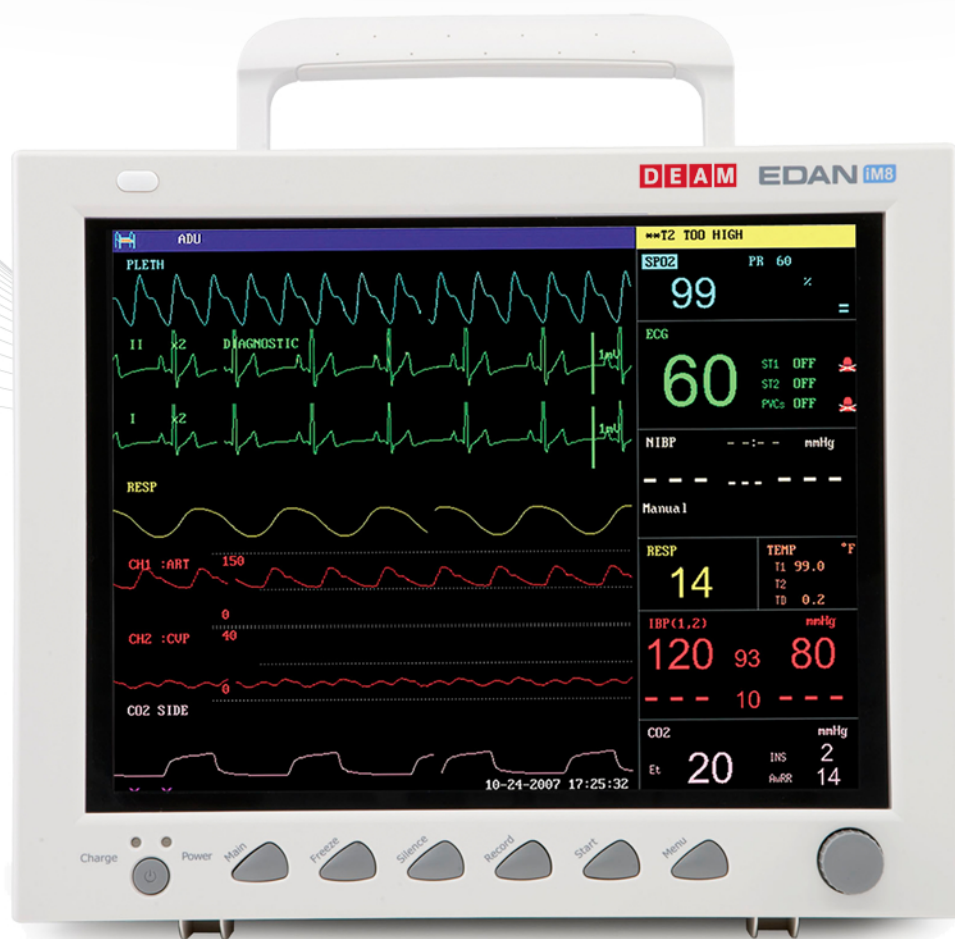

## About this Manual

P/N: .54.100231-19

Release Date: September 2010

© Copyright EDAN INSTRUMENTS, INC. 2007-2010. All rights reserved.



**Imported by:**

**DEAM S.R.L, 30 – 64222464 - 2**  
Av. Maipú 380 – Local 1, Córdoba,  
X5000IBH - Argentina.

**Technical Director: Bioengineer Juan Pablo Giulioni, Mat: 5348 – 28676206**

Autorizado por A.N.M.A.T

**PM- 1317 - 17**

Condition of sale: exclusive professional and Health Institutions

## Statement

This manual will help you understand the operation and maintenance of the product better. It is reminded that the product shall be used strictly complying with this manual. User's operation failing to comply with this manual may result in malfunction or accident for which EDAN INSTRUMENTS, INC. (hereinafter called EDAN) can not be held liable.

EDAN owns the copyrights of this manual. Without prior written consent of EDAN, any materials contained in this manual shall not be photocopied, reproduced or translated into other languages.

Materials protected by the copyright law, including but not limited to confidential information such as technical information and patent information are contained in this manual, the user shall not disclose such information to any irrelevant third party.

The user shall understand that nothing in this manual grants him, expressly or implicitly, any right or license to use any of the intellectual properties of EDAN.

EDAN holds the rights to modify, update, and ultimately explain this manual.

## Responsibility of the Manufacturer

EDAN only considers itself responsible for any effect on safety, reliability and performance of the equipment if:

Assembly operations, extensions, re-adjustments, modifications or repairs are carried out by persons authorized by EDAN, and

The electrical installation of the relevant room complies with national standards, and

The instrument is used in accordance with the instructions for use.

Upon request, EDAN may provide, with compensation, necessary circuit diagrams, and other information to help qualified technician to maintain and repair some parts, which EDAN may define as user serviceable.

## Terms Used in this Manual

This guide is designed to give key concepts on safety precautions.

### **WARNING**

A **WARNING** label advises against certain actions or situations that could result in personal injury or death.

### **CAUTION**

A **CAUTION** label advises against actions or situations that could damage equipment, produce inaccurate data, or invalidate a procedure.

### **NOTE**

A **NOTE** provides useful information regarding a function or a procedure



# Table of Contents

<b>Chapter 1 Intended Use and Safety Guidance .....</b>	<b>1</b>
1.1 Intended Use.....	1
1.2 Safety Guidance .....	1
1.2.1 Environment.....	1
1.2.2 Power Source Requirements .....	1
1.2.3 Grounding the Monitor .....	1
1.2.4 Equipotential Grounding.....	2
1.2.5 Condensation.....	2
1.2.6 Safety Precautions .....	2
1.2.7 Explanation of Symbols on the Monitor .....	5
<b>Chapter 2 Installation of Monitor .....</b>	<b>7</b>
2.1 Opening the Package and Checking.....	7
2.2 Installing Wall Mount for the Monitor (Optional) .....	7
2.3 Connecting the Power Cable.....	8
2.4 Powering on the Monitor .....	9
2.5 Connecting Patient Sensors.....	9
2.6 Checking the Recorder.....	9
<b>Chapter 3 Introduction.....</b>	<b>10</b>
3.1 General Information .....	10
3.2 Screen Display .....	15
3.3 Button Functions .....	19
3.4 Interfaces .....	21
3.5 Built-in Rechargeable Battery.....	24
<b>Chapter 4 System Menu .....</b>	<b>25</b>
4.1 Patient Setup.....	26
4.2 Default Setup.....	27
4.3 Mark Event.....	28
4.4 Face Select .....	29
4.5 Time Setup .....	30
4.6 Record Setup .....	31
4.7 Module Setup .....	33
4.8 Tracing Waveforms Selection .....	33
4.9 Monitor Version .....	34
4.10 Alarm Volume .....	34

4.11 Key Volume .....	35
4.12 Drug Calculation .....	35
4.13 Waveform Demonstration .....	36
4.14 Maintenance .....	36
4.15 Data Storing .....	40
<b>Chapter 5 Face Select.....</b>	<b>45</b>
5.1 Selecting Operating Screen .....	45
5.2 Standard Screen.....	45
5.3 Trend Screen.....	46
5.4 oxyCRG Screen.....	48
5.5 Large Font Screen .....	49
<b>Chapter 6 Alarm.....</b>	<b>53</b>
6.1 Alarm Modes .....	53
6.1.1 Alarm Level.....	53
6.1.2 Alarm Modes .....	53
6.1.3 Alarm Setup.....	55
6.2 Alarm Cause .....	57
6.3 Silence .....	58
6.4 Parameter Alarm.....	58
6.5 When an Alarm Occurs .....	59
<b>Chapter 7 Freeze .....</b>	<b>60</b>
7.1 General .....	60
7.2 Entering/Exiting Freeze Status.....	60
7.3 FROZEN Menu .....	60
7.4 Reviewing Frozen Waveform.....	61
<b>Chapter 8 Recording (Optional) .....</b>	<b>62</b>
8.1 General Information on Recording .....	62
8.2 Recording Type .....	62
8.3 Recording Startup.....	64
8.4 Recorder Operations and Status Messages .....	65
<b>Chapter 9 Trend and Event.....</b>	<b>67</b>
9.1 Trend Graph .....	67
9.2 Trend Table.....	68
9.3 NIBP Recall.....	70
9.4 Alarm Event Recall .....	71
<b>Chapter 10 Drug Calculation and Titration Table (Optional).....</b>	<b>74</b>
10.1 Drug Calculation .....	74

10.2 Titration Table .....	76
<b>Chapter 11 Maintenance/Cleaning .....</b>	<b>78</b>
11.1 System Check.....	78
11.2 General Cleaning.....	78
11.3 Sterilization .....	79
11.4 Disinfection .....	80
11.5 Replacement of Fuse .....	80
11.6 Cleaning Battery and Battery Compartment Cover .....	80
<b>Chapter 12 ECG/RESP Monitoring .....</b>	<b>81</b>
12.1 What Is ECG Monitoring .....	81
12.2 Precautions During ECG Monitoring.....	81
12.3 Monitoring Procedure .....	82
12.3.1 Preparation .....	82
12.3.2 Placing Electrodes for ECG Monitoring.....	83
12.4 ECG Screen Hot Keys.....	88
12.5 ECG Menu .....	89
12.5.1 ECG SETUP.....	89
12.5.2 12-lead ECG.....	96
12.6 ECG Alarm Information.....	103
12.7 ST Segment Monitoring (Optional) .....	106
12.8 Arr. Monitoring (Optional).....	110
12.9 Measuring RESP .....	115
12.9.1 How to Measure RESP.....	115
12.9.2 Setting Up RESP Measurement .....	115
12.9.3 Installing Electrode for RESP Measurement .....	115
12.9.4 RESP SETUP .....	116
12.9.5 RESP Alarm Message .....	119
12.10 Maintenance and Cleaning.....	119
<b>Chapter 13 SpO<sub>2</sub> Monitoring .....</b>	<b>121</b>
13.1 What is SpO <sub>2</sub> Monitoring.....	121
13.2 Precautions during SpO <sub>2</sub> /Pulse Monitoring .....	122
13.3 Monitoring Procedure .....	122
13.4 Limitations for Measurement.....	123
13.5 SpO <sub>2</sub> SETUP .....	123
13.6 Alarm Description .....	125
13.7 Maintenance and Cleaning.....	126
<b>Chapter 14 NIBP Monitoring.....</b>	<b>128</b>

14.1 Introduction.....	128
14.2 NIBP Monitoring.....	129
14.2.1 NIBP Measurement.....	129
14.2.2 NIBP Parameter Setup and Adjustment.....	134
14.3 NIBP SETUP.....	134
14.4 NIBP Alarm Message and Prompt Message.....	137
14.5 Maintenance and Cleaning.....	142
<b>Chapter 15 TEMP Monitoring.....</b>	<b>145</b>
15.1 TEMP Monitoring.....	145
15.2 TEMP SETUP.....	145
15.3 TEMP Alarm Message.....	147
15.4 Care and Cleaning.....	148
<b>Chapter 16 IBP Monitoring (Optional).....</b>	<b>150</b>
16.1 Introduction.....	150
16.2 Precautions during IBP Monitoring.....	150
16.3 Monitoring Procedure.....	151
16.4 IBP Menu.....	152
16.5 Alarm Information.....	159
16.6 Maintenance and Cleaning.....	160
<b>Chapter 17 CO<sub>2</sub> Measuring (Optional).....</b>	<b>162</b>
17.1 General.....	162
17.2 Monitoring Procedure.....	163
17.3 CO <sub>2</sub> SETUP.....	168
17.4 Alarm Information and Prompt.....	175
17.5 Maintenance and Cleaning.....	176
<b>Chapter 18 CO Measuring (Optional).....</b>	<b>178</b>
18.1 General.....	178
18.2 Monitoring Procedure.....	178
18.2.1 CO Measurement Procedure.....	178
18.2.2 CO Measuring.....	180
18.2.3 Blood Temperature Monitoring.....	183
18.3 CO SETUP.....	183
18.4 Hemodynamic Calculation.....	185
18.5 Alarm Information and Prompt.....	187
18.6 Maintenance and Cleaning.....	188
<b>Chapter 19 Anesthetic Gas Measuring (Optional).....</b>	<b>190</b>
19.1 General.....	190



19.2 Measuring Principle and Operating Process .....	191
19.3 Menus.....	194
19.3.1 GAS SETUP.....	194
19.3.2 GAS ALARM SETUP .....	199
19.3.3 ADJUST WAVE SETUP .....	202
19.3.4 DEFAULT menu .....	203
19.4 Alarm information and prompts .....	204
19.5 Maintenance and Cleaning.....	207
<b>Chapter 20 Accessories and Ordering Information.....</b>	<b>209</b>
<b>Chapter 21 Warranty and Service Policy .....</b>	<b>214</b>
21.1 Warranty .....	214
21.2 Service Policy.....	214
<b>AppendixI Specifications .....</b>	<b>215</b>
A1.1 Classification.....	215
A1.2 Specifications .....	215
A1.2.1 Size and Weight.....	215
A1.2.2 Environment .....	215
A1.2.3 Display .....	216
A1.2.4 Battery .....	216
A1.2.5 Recorder (Optional).....	217
A1.2.6 Recall.....	217
A1.2.7 ECG.....	217
A1.2.8 RESP .....	222
A1.2.9 NIBP.....	222
A1.2.10 SpO <sub>2</sub> .....	223
A1.2.11 TEMP .....	225
A1.2.12 IBP (Optional) .....	226
A1.2.13 CO <sub>2</sub> (Optional) .....	227
A1.2.14 CO (Optional).....	228
A1.2.15 GAS (Optional) .....	229
<b>AppendixII EMC Information.....</b>	<b>232</b>
A2.1 Electromagnetic Emissions - for all EQUIPMENT and SYSTEMS .....	232
A2.2 Electromagnetic Immunity - for all EQUIPMENT and SYSTEMS .....	232
A2.3 Electromagnetic Immunity - for EQUIPMENT and SYSTEMS that are not LIFE-SUPPORTING.....	234
A2.4 Recommended Separation Distances .....	235

# Chapter 1 Intended Use and Safety Guidance

## 1.1 Intended Use

The monitor monitors parameters such as ECG (3-lead, 5-lead or 12-lead selectable), Respiration (RESP), Functional arterial oxygen saturation (SpO<sub>2</sub>), Invasive or noninvasive blood pressure (dual-IBP, NIBP), Temperature (dual-TEMP), Cardiac output (CO), Expired CO<sub>2</sub> and Anesthetic gas (AG).

The monitor is intended to be used only under regular supervision of clinical personnel. It is applicable to adult, pediatric, and neonatal usage in a hospital environment and during patient transport inside a healthcare facility.

The monitor is equipped with alarms that indicate system faults (such as loose or defective electrodes), physiologic parameters that have exceeded the limits set by the operator, or both.

## 1.2 Safety Guidance

### 1.2.1 Environment

Follow the instructions below to ensure a completely safe electrical installation. The environment where the monitor will be used should be reasonably free from vibration, dust, corrosive or explosive gases, extremes of temperature, humidity, and so on. For a cabinet mounted installation, allow sufficient room at the front for operation and sufficient room at the rear for servicing with the cabinet access door open.

The monitor operates within specifications at ambient temperatures between 5°C and 40°C. Ambient temperatures that exceed these limits could affect the accuracy of the instrument and cause damage to the modules and circuits. Allow at least 2 inches (5cms) clearance around the instrument for proper air circulation.

### 1.2.2 Power Source Requirements

Refer to *Appendix I* .

### 1.2.3 Grounding the Monitor

To protect the patient and hospital personnel, the cabinet of the monitor must be grounded. Accordingly, the monitor is equipped with a detachable 3-wire cable which grounds the instrument to the power line ground (protective earth) when plugged into an appropriate 3-wire receptacle. If a 3-wire receptacle is not available, consult the hospital electrician.

Connect the grounding wire to the equipotential grounding terminal in the main system. If it is not evident from the instrument specifications whether a particular instrument combination is hazardous or not, for example due to summation of leakage currents, the user should consult the manufacturers concerned or an expert in the field, to ensure that the necessary safety of all instruments concerned will not be impaired by the proposed combination.

## 1.2.4 Equipotential Grounding

Protection class 1 instruments are already included in the protective grounding (protective earth) system of the room by way of grounding contacts in the power plug. For internal examinations on the heart or the brain, the monitor must have a separate connection to the equipotential grounding system. One end of the equipotential grounding cable (potential equalization conductor) is connected to the equipotential grounding terminal on the instrument rear panel and the other end to one point of the equipotential grounding system. The equipotential grounding system assumes the safety function of the protective grounding conductor if ever there is a break in the protective grounding system. Examinations in or on the heart (or brain) should only be carried out in medically used rooms incorporating an equipotential grounding system. Check each time before use that the instrument is in perfect working order. The cable connecting the patient to the instrument must be free of electrolyte.

---

### **WARNING**

If the protective grounding (protective earth) system is doubtful, the monitor must be supplied by internal power only.

---

## 1.2.5 Condensation

Make sure that during operation, the instrument is free of condensation. Condensation can form when equipment is moved from one building to another, and thus being exposed to moisture and differences in temperature.

## 1.2.6 Safety Precautions

**WARNING** and **CAUTION** messages must be observed. To avoid the possibility of injury, observe the following precautions during the operation of the instrument.

---

### **WARNING**

- 1 The monitor is provided for the use of qualified physicians or personnel professionally trained. They should be familiar with the contents of this user manual before operation.
  - 2 Only qualified service engineers can install this equipment. And only service engineers authorized by EDAN can open the shell.
  - 3 **EXPLOSION HAZARD**-Do not use the device in a flammable atmosphere where concentrations of flammable anesthetics or other materials may occur.
  - 4 **SHOCK HAZARD**-The power receptacle must be a three-wire grounded outlet. A hospital grade outlet is required. Never adapt the three-prong plug from the monitor to fit a two-slot outlet.
  - 5 **SHOCK HAZARD**-Do not attempt to connect or disconnect a power cord with wet hands. Make certain that your hands are clean and dry before touching a power cord.
-

---

**WARNING**

---

- 6 Accessory equipments connected to the analog and digital interfaces must be certified according to the respective IEC/EN standards (e.g. IEC/EN 60950 for data processing equipment and IEC/EN 60601-1 for medical equipment). Furthermore all configurations shall comply with the valid version of the standard IEC/EN 60601-1-1. Therefore anybody, who connects additional equipment to the signal input or output connector to configure a medical system, must make sure that it complies with the requirements of the valid version of the system standard IEC/EN60601-1-1. If in doubt, consult our technical service department or your local distributor.
  - 7 The monitor is equipped with a wireless AP via network interface to receive RF electromagnetic energy. Therefore, any other equipment complies with CISPR radiation requirements may also interfere with the wireless communication and make it interrupted.
  - 8 Make sure the device is used in the appointed range of voltage, and the effect of power supply can not be noticed.
  - 9 Before using the rechargeable lithium-ion battery (hereinafter called battery), be sure to read the user manual and safety precautions thoroughly.
  - 10 Do not place battery in the monitor with the (+) and (-) in the wrong way around.
  - 11 Do not connect the positive (+) and negative (-) terminals with metal objects, and do not put the battery together with metal object, which can result in short circuit.
  - 12 Do not unplug the battery when monitoring.
  - 13 Do not heat or throw battery into a fire.
  - 14 Do not use, leave battery close to fire or other places where temperature may be above 60°C.
  - 15 Do not immerse, throw, or wet battery in water/seawater.
  - 16 Do not destroy the battery: do not pierce battery with a sharp object such as a needle; Do not hit with a hammer, step on or throw or drop to cause strong shock; Do not disassemble or modify the battery.
  - 17 Use the battery only in the monitor. Do not connect battery directly to an electric outlet or cigarette lighter charger.
  - 18 Do not solder the leading wire and the battery terminal directly.
  - 19 If liquid leaking from the battery gets into your eyes, do not rub your eyes. Wash them well with clean water and go to see a doctor immediately. If liquid leaks of the battery splash onto your skin or clothes, wash well with fresh water immediately.
  - 20 Keep away from fire immediately when leakage or foul odor is detected.
  - 21 Stop using the battery if abnormal heat, odor, discoloration, deformation or abnormal condition is detected during use, charge, or storage. Keep it away from the monitor.
-

---

**WARNING**

---

- 22 Do not use a battery with serious scar or deformation.
  - 23 Only patient cable and other accessories supplied by EDAN can be used. Or else, the performance and electric shock protection can not be guaranteed, and the patient may be injured.
  - 24 The user should check the monitor and accessories before use.
  - 25 Be sure that all electrodes have been connected to the patient correctly before operation.
  - 26 When connecting the cables and electrodes, make sure no conductive part is in contact with the ground. Verify that all ECG electrodes, including neutral electrodes, are securely attached to the patient.
  - 27 Do not touch the patient, bed or instrument during defibrillation.
  - 28 Please set the alarm according to the individual status of patient to avoid delaying treatment. Ensure there will be alarm audio prompt when alarming.
  - 29 Devices connecting with monitor should be equipotential.
  - 30 When the monitor and electrosurgical device are used together, the user (physician or nurse) should guarantee the safety of patient.
  - 31 CO2 module shall be avoided from crash and vibration.
  - 32 The patient monitor will be damaged if the water quantity in the water trap reaches the limit.
  - 33 The machine will be damaged if any pipeline from the CO2 module has been disconnected, or the air tube/air inlet/air outlet has been plugged by water or other materials.
  - 34 The accuracy of the measurement of the CO2 will be affected by the following reasons: The air way was highly obstructed or air leaks; The leakage of air way connection or quick variation of environment temperature.
  - 35 Do not startup the CO2 module if the water trap was not connected. This is to avoid the machine from damage after impurity enters the pipeline.
  - 36 Please replace the water trap if it is nearly full.
  - 37 Please sterilize and disinfect timely to prevent the cross infection between patients.
  - 38 This equipment is not intended for family usage.
  - 39 Do not unplug the USB storage during storing data. If the damaged data caused by unplugging the USB storage during data storing can not be deleted on the monitor, the user can delete it on the PC.
  - 40 During monitoring, if the power supply is off and there is no battery for standby, the monitor will be off. After reconnecting the power supply, the user should turn on the monitor for monitoring.
-

**CAUTION**











- 1 Electromagnetic Interference -Ensure that the environment in which the patient monitor is installed is not subject to any sources of strong electromagnetic interference, such as radio transmitters, mobile telephones, etc.
- 2 The monitor is designed for continuous operation and is “ordinary” (i.e. not drip or splash-proof).
- 3 Keep the environment clean. Avoid vibration. Keep it far from corrosive medicine, dust area, high temperature and humid environment.
- 4 Do not immerse transducers in liquid. When using solutions, use sterile wipes to avoid pouring fluids directly on the transducer.
- 5 Do not use autoclave or gas to sterilize the monitor, recorder or any accessories.
- 6 The device and reusable accessories could be sent back to the manufacturer for recycling or proper disposal after their useful lives.
- 7 Remove a battery whose life cycle has expired from the monitor immediately.
- 8 Avoid liquid splash and excessive temperature. The temperature must be kept between 5°C and 40°C while working. And it should be kept between -20°C and 55 °C during transportation and storage.
- 9 Before use, the equipment, patient cable and electrodes etc. should be checked. Replacement should be taken if there is any evident defectiveness or aging symptom which may impair the safety or performance.

**NOTE :**

- 1 The monitor can only be used on one patient at a time.
- 2 The monitor may not be compatible with all models of USB disks, It is recommended to use PNY USB disk of 1G or 2G.
- 3 If the monitor gets damp, put it in dry circumstance to dry it until it can work normally. If liquid pours on the monitor, please contact the service personnel of EDAN.
- 4 The manufacturer suggests that the lifetime of the monitor is 5 years.
- 5 This monitor is not a device for treatment purpose.
- 6 The function of SpO<sub>2</sub> measurement does not require calibration.
- 7 The pictures and interfaces in this manual are for reference only.

**1.2.7 Explanation of Symbols on the Monitor**

	<p>This symbol indicates that the equipment is IEC/EN60601-1 Type CF equipment. The unit displaying this symbol contains an F-Type isolated (floating) patient applied part providing a high degree of protection against shock, and is suitable for use during defibrillation.</p>
---	---

	<p>This symbol indicates that the instrument is IEC/EN 60601-1 Type BF equipment. The unit displaying this symbol contains an F-Type isolated (floating) patient applied part providing a high degree of protection against shock, and is suitable for use during defibrillation.</p>
	<p>Caution</p>
	<p>Consult Instructions for Use</p>
	<p>Equipotential grounding system</p>
	<p>Stand-by. It designates that the switch or switch position which one part of the monitor has been switched on, while the monitor is at the status of stand-by.</p>
	<p>Serial number</p>
	<p>The symbol indicates that the device complies with the European Council Directive 93/42/EEC concerning medical devices.</p>
	<p>Authorised representative in the European community</p>
	<p>Date of manufacture</p>
	<p>Manufacturer</p>
<p><b>P/N</b></p>	<p>Part Number</p>
	<p>Recycle</p>





## Chapter 2 Installation of Monitor

Installation should be carried out by qualified service personnel, either by the hospital's biomedical department, or by EDAN Support.

For mechanical and electrical installation, you need technically qualified personnel with a knowledge of english. Additionally, for monitor configuration, you need clinically qualified personnel with a knowledge of the use environment.

### NOTE:

- 1 The monitor configuration settings must be specified by authorized hospital personnel.
- 2 To ensure that the monitor works properly, please read *Chapter Safety Guidance*, and follow the steps before using the monitor.

### 2.1 Opening the Package and Checking

Visually examine the package prior to unpacking. If any signs of mishandling or damage are detected, contact the carrier to claim for damage. Open the package and take out the monitor and accessories carefully. Keep the package for possible future transportation or storage. Check the components according to the packing list.

- 👁 Check for any mechanical damage.
- 👁 Check all the functions, cables and accessories.

If there is any problem, contact the manufacturer or local representative immediately.

### 2.2 Installing Wall Mount for the Monitor (Optional)

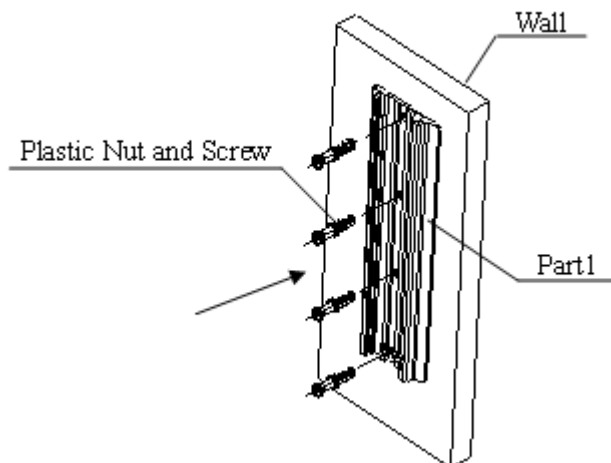

Figure 2-1

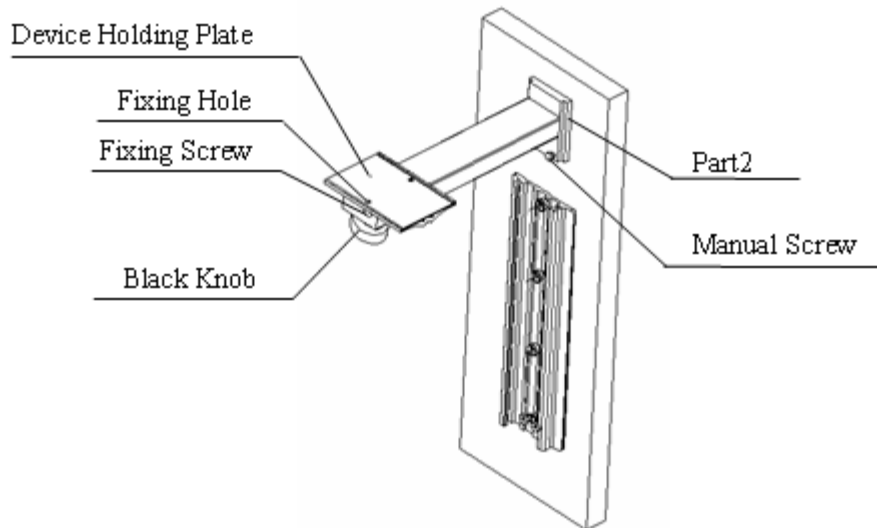

Figure 2-2

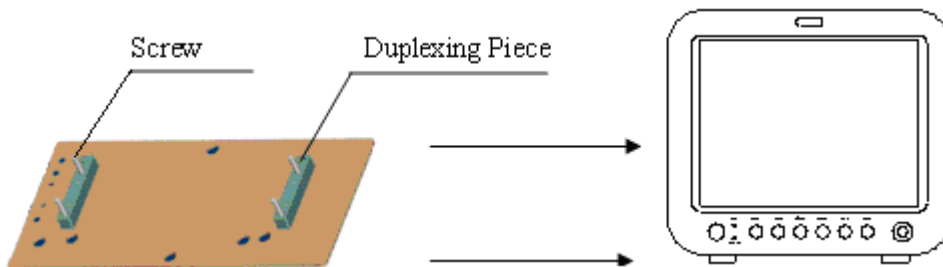

Figure 2-3

#### Installation Steps:

1. Outline along the part 1 edge against the wall to the desired location.
2. Drill 4 holes of 6mm in diameter in the wall, and knock the plastic nuts in the holes completely.
3. Knock 4 screws in the plastic nuts, when tightening them, secure the channel (part 1) at the desired location of the wall (as shown in Figure 2-1).
4. Slide the arm (part2) into channel (part1) as Figure2-2 shows to the desired location.
5. Tighten the manual screw and secure the arm (part2) at the desired position within the channel (part1).
6. Face the side with duplexing piece of the device holding plate to the underside of the patient monitor, fix it with an M4×25mm screw (as shown in Figure 2-3).
7. Pull out the fixing screw from the fixing hole.
8. At the same time, put the arm (part2) into the patient monitor with the device holding plate, and secure the fixing screw totally through the fixing hole.
9. The patient monitor can be adjusted by a maximum of 15 degrees by rotating the black knob.

## 2.3 Connecting the Power Cable

Connection procedure of the AC power line:

- 👁️ Make sure the AC power supply complies with the following specifications: 100V-240V~, 50Hz/60Hz.
- 👁️ Apply the power line provided with the monitor. Plug the power line to INPUT interface of the monitor. Connect the other end of the power line to a grounded 3-phase power output.

**NOTE:**

Connect the power line to the jack special for hospital usage.

- 👁️ Connect to the ground line if necessary. Refer to *Section 1.2 Safety Guidance* for details.

**NOTE:**

When the battery configuration is provided, after the device is transported or stored, the battery must be charged. Powering on without connecting AC power supply may cause the device to malfunction. Switching on AC power supply can charge the battery no matter if the monitor is powered on.

## 2.4 Powering on the Monitor

After you power on the monitor, LOGO information will be displayed on the screen.

---

**WARNING**

---

If any sign of damage is detected, or the monitor displays some error messages, do not use it on any patient. Contact biomedical engineer in the hospital or Customer Service Center immediately.

---

**NOTE:**

- 1 Check all the functions of the monitor and make sure that the monitor is in good status.
- 2 If rechargeable batteries are provided, charge them after using the device every time, to ensure the electric power is enough.
- 3 The interval between double pressing of POWER switch should be longer than 1 minute.
- 4 After continuous 360-hour runtime, please restart the monitor to ensure the monitor's steady performance and long lifespan.

## 2.5 Connecting Patient Sensors

Connect all the necessary patient sensors between the monitor and the patient.

**NOTE:**

For information on correct connection, refer to related chapters.

## 2.6 Checking the Recorder

If your monitor is equipped with a recorder, open the recorder's door to check if paper is properly installed in the slot. If no paper exists, refer to *Chapter 8 Recording* for details.

# Chapter 3 Introduction

## 3.1 General Information

The monitor integrates the functions of parameter measurement module, display, recording and output to compose a compact, portable device. Its built-in replaceable battery provides convenience for patient movement. On the high-resolution display screen, 7 waveforms and all the monitoring parameters can be displayed clearly.

The **POWER** switch is on the left of the front panel (Figure 3-1, 3-2 ①). The **POWER** indicator lights when the monitor is powered on (Figure 3-1, 3-2 ②). The **CHARGE** indicator shows the charging status (Figure 3-1, 3-2 ③). The **ALARM** indicator flashes when the alarm is triggered (Figure 3-1, 3-2 ④). The sockets of various sensors are on the left panel. Other sockets and the power plug-in are on the rear panel. The recorder is on the right panel.

The monitor is a user-friendly device with operations conducted by a few buttons and a rotary knob on the front panel (Figure 3-1, 3-2 ⑤⑥). Refer to *Section 3.3 Button Functions*.

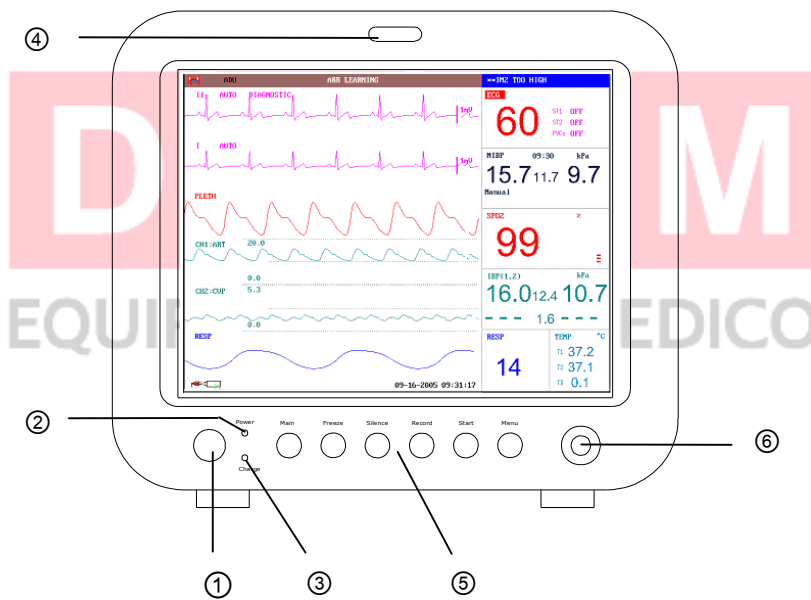

Figure 3-1 M9 Patient Monitor

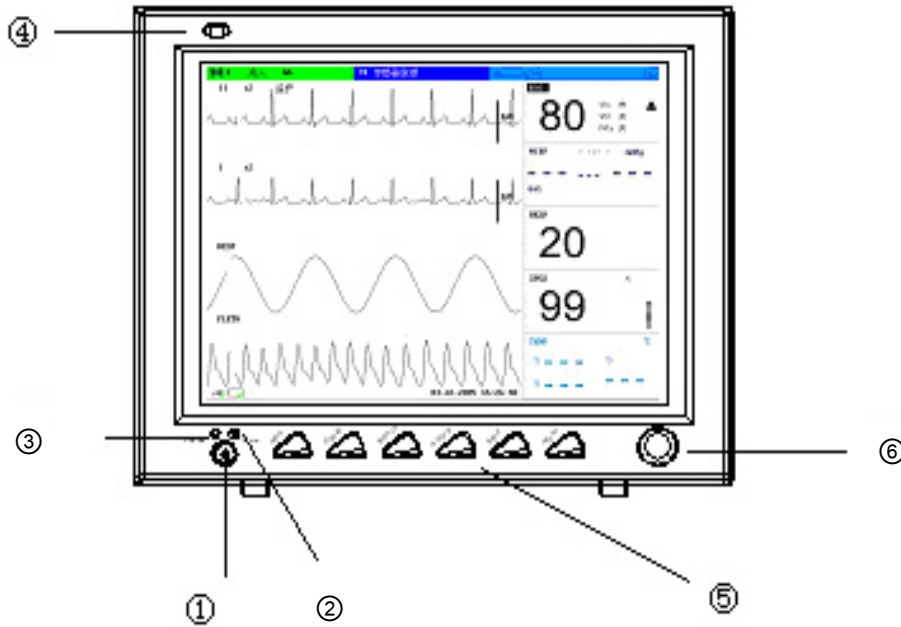

Figure 3-2 M8 Patient Monitor

The monitor has 6 models: M9, M9A, M9B, M8, M8A and M8B.

Product models	Size (L×W×H)	Shell figure / Screen size	Functions
M9	Host: 322mm×150mm×285mm	Round / 12.1-inch	ECG/RESP, SpO <sub>2</sub> , NIBP, TEMP, IBP, CO, CO <sub>2</sub> , GAS
M9A	Host: 322mm×150mm×285mm	Round / 10.4-inch	ECG/RESP, SpO <sub>2</sub> , NIBP, TEMP, IBP, CO, CO <sub>2</sub> , GAS
M9B	Host: 320mm×150mm×265mm	Square / 10.4-inch	ECG/RESP, SpO <sub>2</sub> , NIBP, TEMP, IBP, CO <sub>2</sub>
M8	Host: 320mm×150mm×265mm	Square / 12.1-inch	ECG/RESP, SpO <sub>2</sub> , NIBP,TEMP, IBP, CO <sub>2</sub>
M8A	Host: 320mm×150mm×265mm	Square / 10.4-inch	ECG/RESP, SpO <sub>2</sub> , NIBP, TEMP, IBP, CO <sub>2</sub>
M8B	Host: 320mm×150mm×265mm	Square / 10.1-inch Width_screen	ECG/RESP, SpO <sub>2</sub> , NIBP, TEMP, IBP

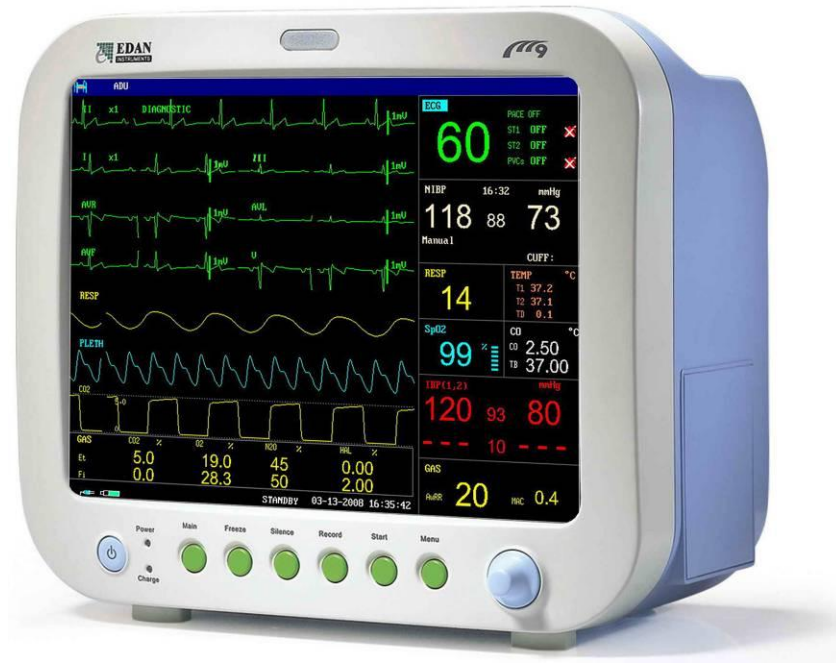

Figure 3-3 M9 Patient Monitor



Figure 3-4 M9A Patient Monitor

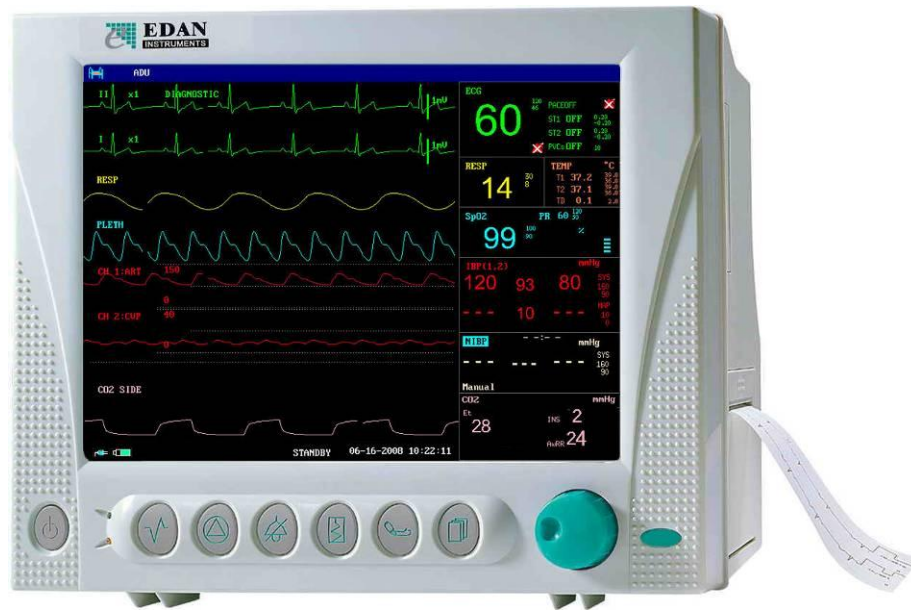

Figure 3-5 M9B Patient Monitor

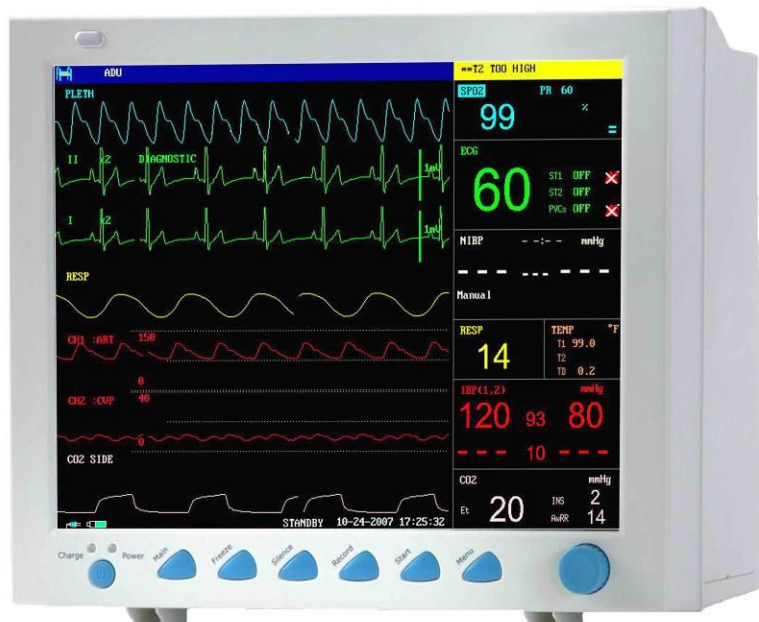
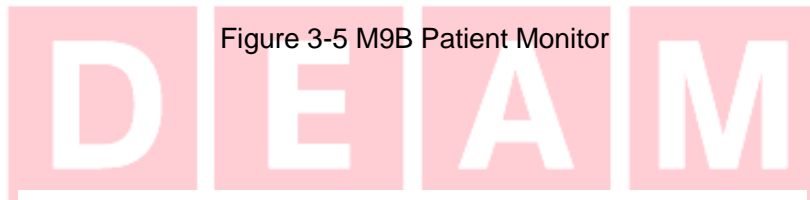

Figure 3-6 M8 Patient Monitor

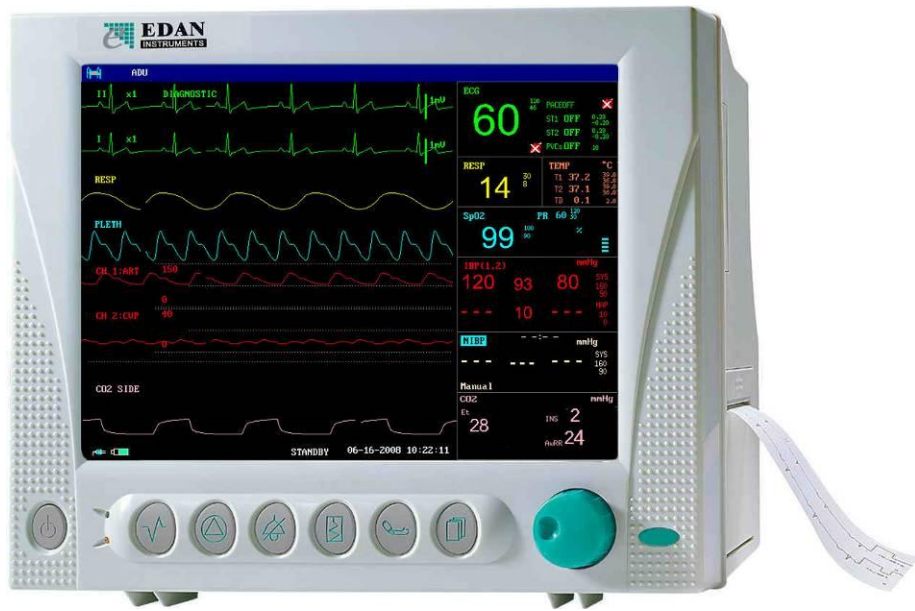

Figure 3-7 M8A Patient Monitor

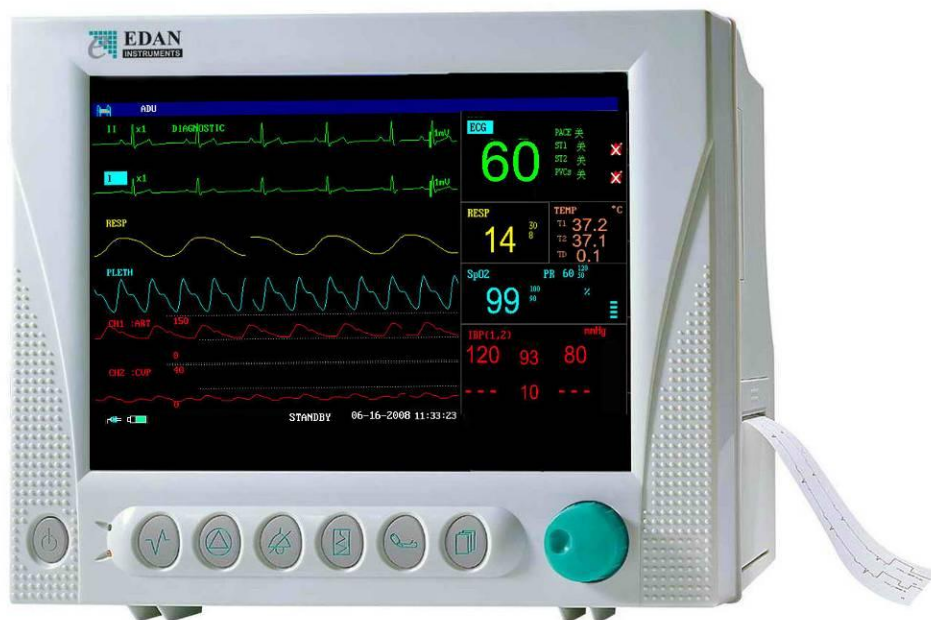

Figure 3-8 M8B Patient Monitor

The monitor can monitor the following parameters and waveforms:

ECG: Heart Rate (HR)



	Maximum 7-channel/12-channel ECG waveform Arrhythmia and ST-segment analysis (optional)
RESP:	Respiration Rate (RR) Respiration Waveform
SpO <sub>2</sub> :	Oxygen Saturation (SpO <sub>2</sub> ), Pulse Rate (PR) SpO <sub>2</sub> Plethysmogram
NIBP:	Systolic Pressure (SYS), Diastolic Pressure (DIA), Mean Pressure (MAP), PR (NIBP)
TEMP:	Channel-1 Temperature (T1), Channel-2 Temperature (T2), Temperature Difference between two channels (TD)
IBP:	Channel-1 SYS, DIA, MAP Channel-2 SYS, DIA, MAP Dual-IBP waveforms
CO <sub>2</sub> :	End Tidal CO <sub>2</sub> (EtCO <sub>2</sub> ) Inspired Minimum CO <sub>2</sub> (InsCO <sub>2</sub> ) Air Way Respiration Rate (AwRR) CO <sub>2</sub> waveform
CO:	Blood Temperature (TB) Cardiac Output (CO)
GAS:	Inspired or expired CO <sub>2</sub> (FICO <sub>2</sub> , ETCO <sub>2</sub> ) Inspired or expired N <sub>2</sub> O (FIN <sub>2</sub> O, ETN <sub>2</sub> O) Inspired or expired O <sub>2</sub> (FIO <sub>2</sub> , ETO <sub>2</sub> ) Inspired or expired Anesthetic Agent (FIAA, ETAA): HAL (Halothane) ISO (Isoflurane) ENF (Enflurane) SEV (Sevoflurane) DES (Esflurane) Airway respiration rate (respiring time per minute, BPM), AwRR Minimal Alveolar Concentration (MAC) 4 anesthetic gas waveforms (CO <sub>2</sub> , N <sub>2</sub> O, O <sub>2</sub> , AA)

The monitor provides extensive functions such as visual and audible alarms, storage for trend data, NIBP measurements, alarm events, drug dose calculation, wireless network function and so on.

### 3.2 Screen Display

The monitor is equipped with a high-resolution multicolor TFT LCD screen. The patient parameters, waveforms, alarm messages, bed number, time, monitor status and other data can be

reflected from the screen.

The screen is divided into three areas:

- 1 Information Area ① ④;
- 2 Waveform Area ②;
- 3 Parameter Area ③.

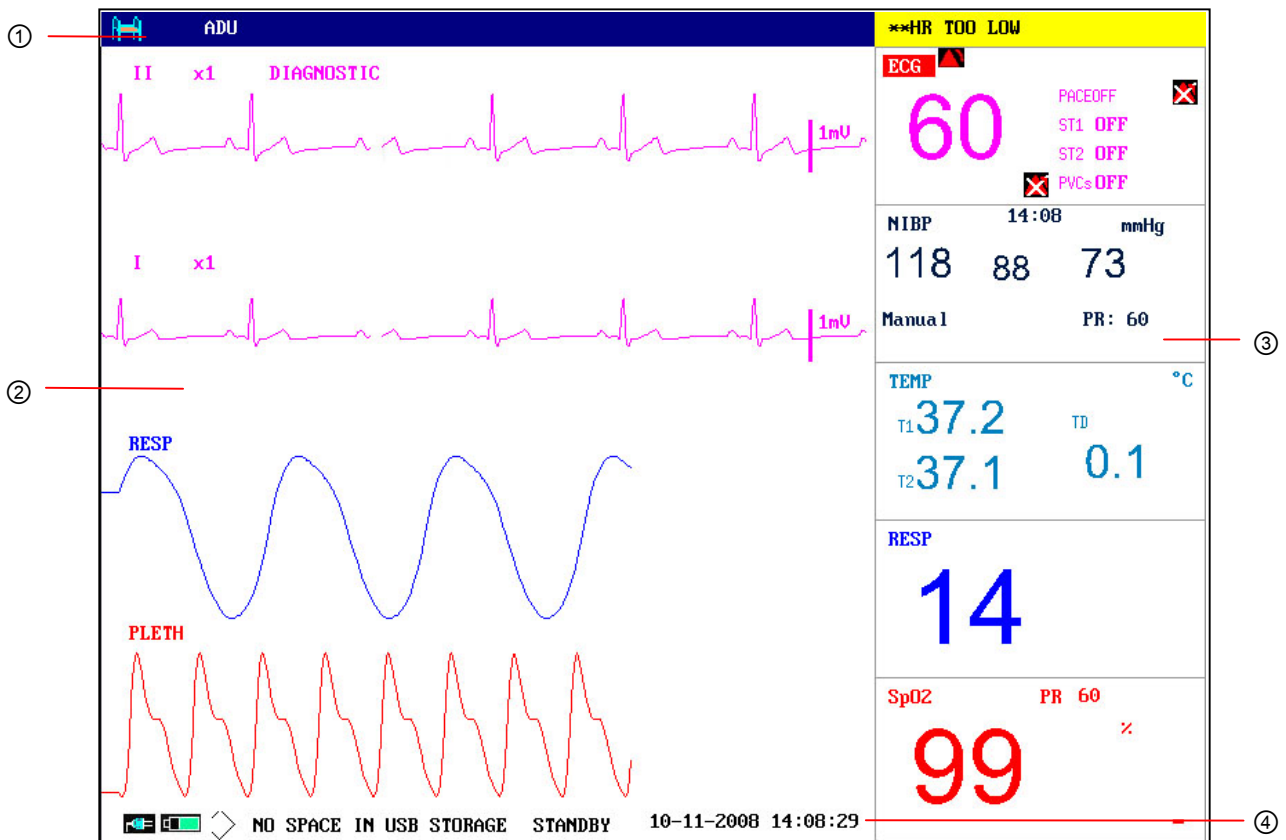

Figure 3-9 Main Display

**Information Area (① ④)**

The Information Area is at the top and bottom of the screen, displaying the operating state of the monitor and the status of the patient.

The information area contains the following data:



Bed number of the monitored patient

**ADU**

Type of patient. Three options: Adult, Pediatric, Neonatal.

**Name**

Name of the monitored patient, when the user inputs patient name, this name will be displayed on the right side of the patient type. If the user doesn't input patient name, this position will be vacant.

**10-11-2008**









Current date

**14: 08: 29**

Current time



Indicates the status of mains power supply

-  means the mains power supply is on,
-  means the mains power supply is off.
-  Indicates the battery and its capacity;
-  gives information about remaining battery charge, estimated operating time and maintenance requirements;
-  means there is no battery equipped in the monitor.
-  Indicates the audio alarm is turned off.
-  Indicates the audio alarm is paused.
-  Displays beside a parameter to indicate the alarm is turned off.
-  USB storage indicator

**STANDBY**

Select this item to enter Standby mode, the dialog pops up:

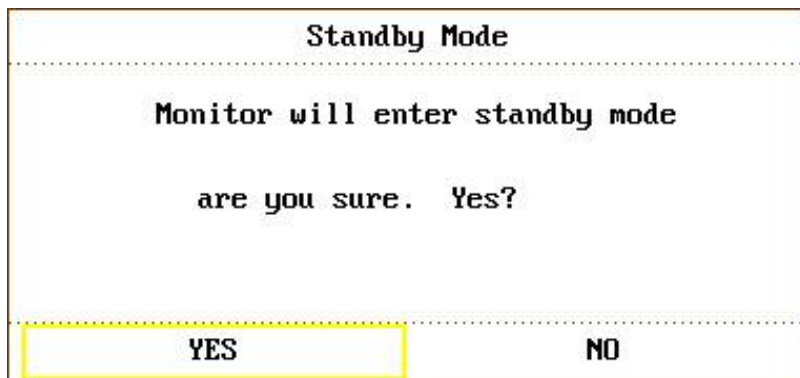





Figure 3-10 Standby Mode

Select **YES** to enter Standby mode and display the current time; if you select **NO**, the monitor will return to the main display.

Other information of the Information Area comes up only with respective monitoring status. They are:

-  Signs indicating the operating status of the monitor and the sensors are displayed at the right side of patient name.
-  Alarm message is displayed in the right most area.
-  “FREEZE” appears when the waveforms are frozen.

**Waveform Area (2)**

Seven waveforms can be displayed at the same time. The sequence of waveforms can be adjusted. With the maximum configuration, the system can display 2 ECG waveforms, an SpO<sub>2</sub> waveform, a respiration waveform (can be from ECG module), 2 IBP waveforms and a CO<sub>2</sub> waveform.

In the **TRACE SETUP** menu, all the waveforms are listed. The user can select the waveform to be displayed, and adjust the display position. Refer to *Section 4.8 Tracing Waveforms Selection* for details.

The name of the waveform is displayed on the upper left part of the waveform. The name of ECG is user-selectable. Gain and filter way of this channel are displayed as well. A 1mV scale is marked on the right of ECG waveform. The IBP waveform scale can also be selected according to the actual requirement. Its range is described in the part: IBP Monitoring. In the IBP waveform area, the waveform scale is displayed. The three dotted lines for each IBP waveform from up to down represent respectively the upper limit scale, reference scale and lower limit scale. The values of these three scales can be set. The specific method is given in the part: IBP Monitoring.

When a certain menu is displayed, some waveforms become invisible. Main display is restored when you exit the menu.

The user may set up the rate to refresh the waveform. The method to adjust the refreshing rate of each waveform is discussed in the setup description of each parameter.

### Parameter Area (③)

Parameter area is on the right of Waveform area, and parameters are displayed corresponding to waveforms basically. They are:

#### ECG:

- ↓ Heart Rate (Unit: beats per minute, bpm)
- ↓ ST-segment analysis of Channel 1 & 2-ST1, ST2 (Unit: mV)
- ↓ PVCs (Premature Ventricular Contraction) events (Unit: event/min)

#### SpO<sub>2</sub>:

- ↓ Oxygen Saturation SpO<sub>2</sub> (Unit: %)
- ↓ PR (Unit: BPM)

#### NIBP:

- ↓ Systolic pressure, Mean pressure, Diastolic pressure (Unit: mmHg or kPa)
- ↓ PR (NIBP) (Unit: BPM)

#### TEMP:

- ↓ Temperatures of channel 1, channel 2 and their temperature difference: T1, T2, TD (Unit: °C or °F)

#### RESP:

- ↓ Respiration Rate (Unit: breath/min)

#### IBP:

- ↓ The blood pressure of channel 1 and 2. From left to right, there are Systolic pressure, Mean pressure and Diastolic pressure ( Unit: mmHg or kPa)

#### CO<sub>2</sub>:

- ↓ EtCO<sub>2</sub> (Unit: %, mmHg or kPa)
- ↓ INS CO<sub>2</sub> (Unit: %, mmHg or kPa)
- ↓ AwRR (Unit: times/minute)

CO:

↓ CO (Unit: liter/minute)

↓ TB (Unit: °C or °F)

GAS:

↓ Airway Respiring Rate (Respiring per minute)

↓ Minimal Alveolar Concentration.

### Alarm Indicator and Alarm Status

In normal status, the alarm indicator does not light.

When an alarm occurs, the alarm indicator will light or flash. The color of light represents the alarm level. Refer to *Chapter6 Alarm* for details.

Refer to relative content of parameter for Alarm information and prompt.

### Charge Indicator and Charge Status

To indicate the status of charging: When the battery is charged, the light color turns to orange.

## 3.3 Button Functions

All the operations to the monitor can be finished by several buttons and a knob. They are:

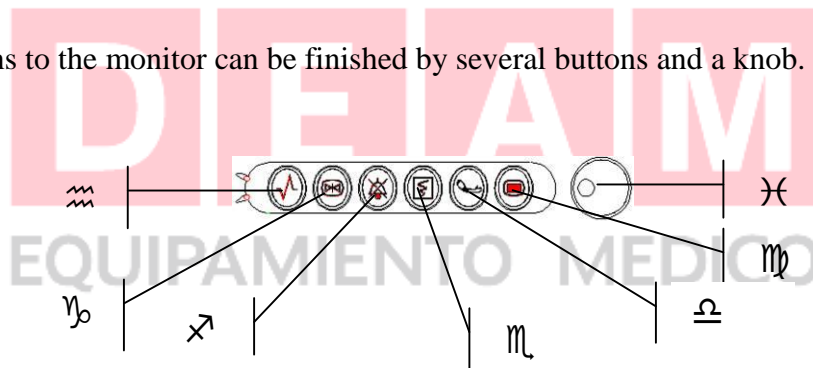



Figure 3-11 Buttons

① <b>Menu</b>	Press to call up the <b>SYSTEM MENU</b> . Refer to <i>Chapter4 SYSTEM MENU</i> and <i>Chapter9 Trend and Event</i> for details.
② <b>Start</b>	Press to fill air into cuff and start blood-measuring. During the measuring process, press the button to stop measure.
③ <b>Record</b>	Press to start a real-time recording. The recording time is set in <b>RT REC TIME</b> of <b>RECORD</b> submenu.
④ <b>Silence</b>	When the <b>SYSTEM MENU &gt; MAINTAIN &gt; USER MAINTAIN &gt; LARM SETUP</b> is set to <b>ON</b> , press this button to silence the alarm. All the alarm audio will be closed. At the same time, “ <b>ALARM SILENCE</b> ×× s” and  will be displayed in the Information area. When you repress it or the pause time is over, the system will resume

	<p>the normal monitoring status, and “<b>Alarm Pause</b> ×× s” and icon will vanish.</p> <p>Pressing this button and holding for more than 3 seconds can turn off the audio alarm.  is shown in the Information area. Pressing or holding the button again can resume the alarm.</p> <p><b>NOTE:</b></p> <p>Whether an alarm will be reset depends on the status of the alarm cause. But pressing <b>SILENCE</b> button (suspend alarm) can permanently shut off audio sound of the Lead Off or Sensor Off alarms. So the user can exit the Alarm Silence Status by Technical Alarm.</p>
⑤ <b>Freeze</b>	In normal mode, press this button to freeze all the waveforms on the screen. In <b>FREEZE</b> mode, press this button to restore the waveform refreshing.
⑥ <b>Main</b>	Press this button to return to the main interface.
⑦ <b>Rotary Knob</b>	The user can use the rotary knob to select the menu item and modify the setup. It can be rotated clockwise or anticlockwise and pressed. The user can use the knob to realize the operations on the screen, in the <b>SYSTEM MENU</b> and parameter menu.

### Method to Use the Knob to Operate on the Screen:

The rectangular mark on the screen that moves with the rotation of the knob is called “cursor”. Operation can be performed at any position at which the cursor can stay.

When the cursor is in the waveform area, the user may immediately modify the current setup. When the cursor is in the parameter area, the user may open the setup menu of the corresponding parameter module so as to set up the menu items of the module.

Operating method:

- ① Move the cursor to the item where the operation is required.
- ② Press the knob.
- ③ One of the following four situations may appear:
  1. The cursor with background color may become a frame without background color, which implies that the content in the frame can change with the rotation of the knob.
  2. Menu or measuring window may appear on the screen, or the original menu is replaced by the new menu.
  3. A check mark “ ” appears at the position, indicating that the item is confirmed.
  4. The system immediately executes a certain function.

## 3.4 Interfaces

For the convenience of operator, interfaces of different functions are in different sites of the monitor. There is a USB port on the panel for connecting USB storage.

### Right Side of the Monitor

At the right side of the monitor, there are a bracket of water trap for CO<sub>2</sub> module and an anesthetic gas module water slot (①), and the recorder's paper inlet cover (②).

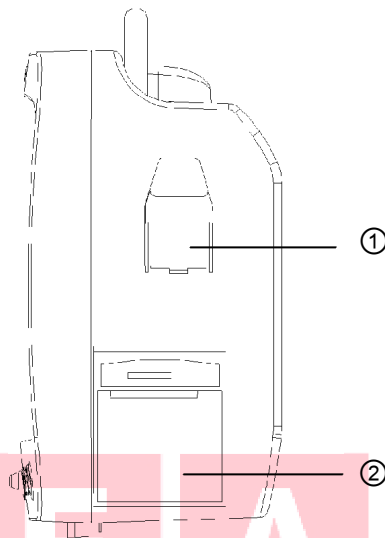

Figure 3-12 Right Panel of M9, M9A

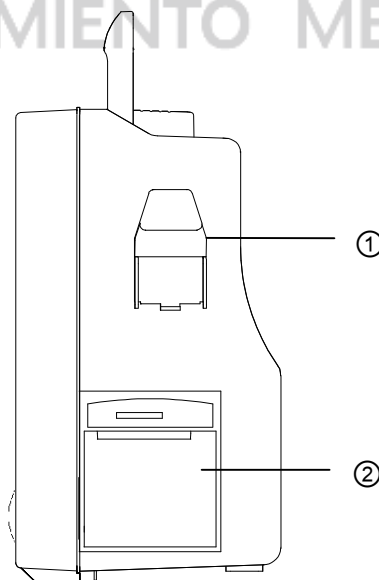

Figure 3-13 Right Panel of M9B, M8, M8A and M8B

### Left Side of the Monitor

Connectors for cables and sensors are as shown in the following figure.

1. Air inlet

2. CO<sub>2</sub> sensor connector
3. IBP1 transducer connector
4. ECG cable connector
5. NIBP cuff connector
6. Air outlet
7. TEMP1 probe connector
8. TEMP2 probe connector
9. IBP2 transducer connector
10. CO sensor connector
11. SpO<sub>2</sub> sensor connector

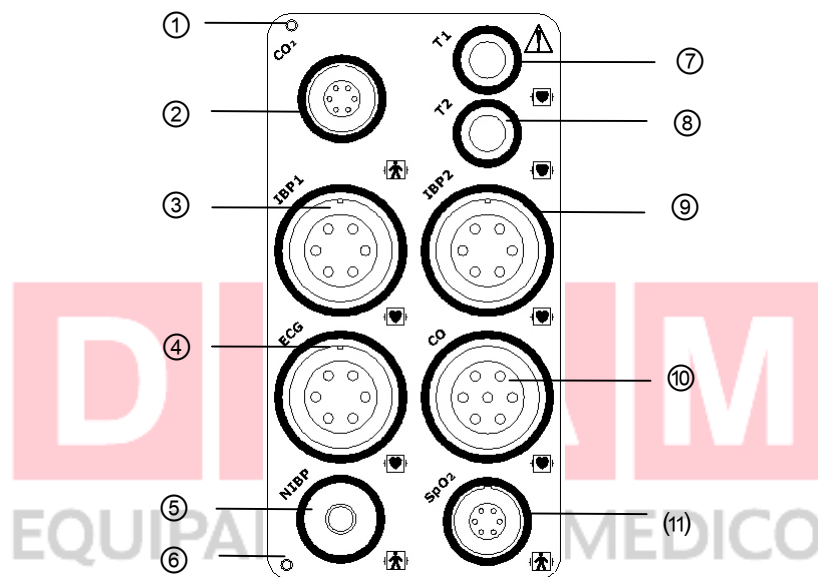

Figure 3-14 Left Panel



## Rear Panel



Figure 3-15 Rear Panel of M9 and M9A



Figure 3-16 Rear Panel of M9B, M8, M8A and M8B



Sockets on the rear panel are as shown in Figure 3-15, 3-16.

- ① Network Interface (reserved): Standard RJ45 Socket, for connecting to MFM-CMS of EDAN, or wireless network.
- ② USB port (M9 and M9A only)
- ③ Equipotential grounding terminal for connection with the hospital's grounding system.
- ④ Fuse box, in which fuses are put.
- ⑤ Power supply socket: 100V-240V~, 50 Hz/60 Hz.
- ⑥ Probe Holder (optional), used to place various types of probes.

## **WARNING**

Accessory equipment connected to the analog and digital interfaces must be certified according to the respective IEC/EN standards (e.g. IEC/EN 60950 for data processing equipment and IEC/EN 60601-1 for medical equipment). Furthermore all configurations shall comply with the valid version of the standard IEC/EN 60601-1-1. Therefore anybody, who connects additional equipment to the signal input or output connector to configure a medical system, must make sure that it complies with the requirements of the valid version of the system standard IEC/EN 60601-1-1. If in doubt, consult our technical service department or your local distributor.

### **3.5 Built-in Rechargeable Battery**

The monitor is equipped with a built-in chargeable battery. When the AC power supply is switched on, the battery will be charged automatically until the electric energy becomes full. There is a sign “” in the lower left corner of screen to show the charging status, and the green part is the electric energy of battery. When the monitor is not equipped with battery, the battery status will be shown as the sign “”, which means no battery.

One battery can power the monitor. Under the cable connectors is the cover of battery compartment. See Battery compartment in the following figure.

The charging time for battery resuming to 90% of the electric energy is about 150min for 2Ah, and 360min for 4Ah.

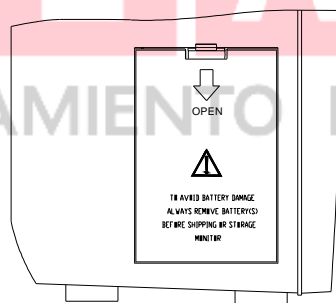

Figure 3-17 Battery Compartment

### **Replace Battery**

When the lifespan of battery is over, or foul odor and leakage has been detected, please contact manufacturer or local distributor for replacement of battery.

## **WARNING**

- 1 Do not unplug the battery during monitoring. When the AC power supply is switched off unexpectedly, the device will not be affected, if it has a standby battery.
- 2 Stop using the battery if abnormal heat, odor, discoloration, deformation or abnormal condition is detected during use, charge, or storage. Keep it away from the monitor.
- 3 Make sure the device is used in the appointed range of voltage, and the effect of power supply can not be noticed.

## Chapter 4 System Menu

The **SYSTEM MENU** is introduced in this chapter.

The monitor features in flexible configurations. You can configure various aspects of the monitor, including the parameters to be monitored, sweeping speed of the waveforms, audio signal volume, and output content.

Press the **MENU** button on the front panel to call up **SYSTEM MENU**. You can perform the following operations in this menu.

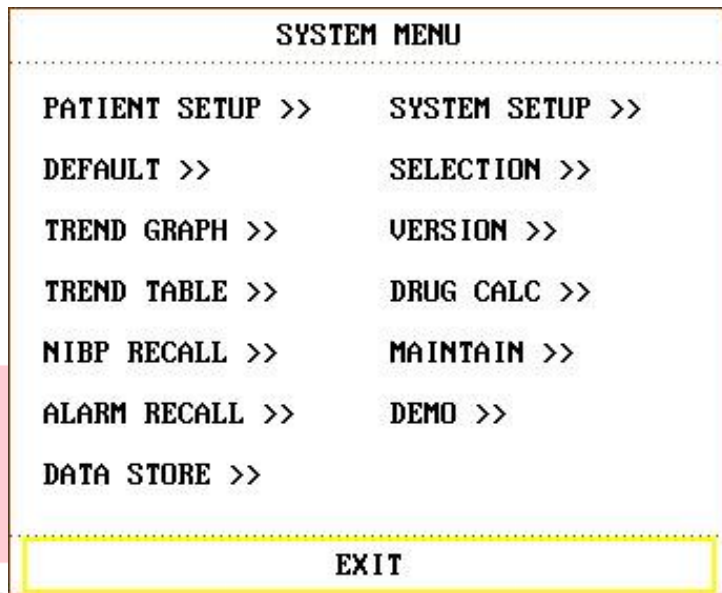

Figure 4-1 System Menu

Select **SYSTEM SETUP >>** to see the following menu:

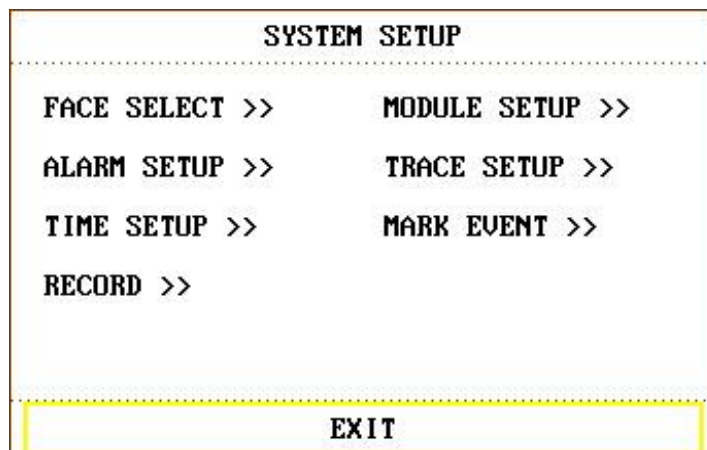

Figure 4-2 System setup

Review of trend graphs/tables, NIBP measurements and alarm recall will be described in *Chapter9 Trend and Event*.

### 4.1 Patient Setup

Pick **PATIENT SETUP** in **SYSTEM MENU** to call up the following menu.

**PATIENT SETUP**

---

DEPT.  ADMIT

PAT NO ..... BIRTH

BED NO ..... HEIGHT cm

DOCTOR ..... WEIGHT kg

NAME ..... BLOOD

SEX ..... NEW PATIENT

PAT TYPE ADU

A	B	C	D	E	F	G	H	I	J	K	L	M	N	O	P	Q	R	S	T	U
V	W	X	Y	Z	0	1	2	3	4	5	6	7	8	9			DEL	OK		

---

**EXIT**

Figure 4-3 Patient Setup

You can set up the following patient information:

<b>DEPT.</b>	Department in which the patient receives treatment.
<b>PAT NO</b>	Patient Number
<b>BED NO</b>	Patient bed number (Range: 1 ~ 254)
<b>DOCTOR</b>	Name of the doctor.
<b>NAME</b>	Patient name (Valid characters: A ~ Z, 0 ~ 9; Maximum length: 12 characters)
<b>SEX</b>	Patient gender (Available options: "F" for Female, "M" for Male)
<b>PAT TYPE</b>	Patient type (Available options: <b>ADU</b> , <b>PED</b> , and <b>NEO</b> )
<b>ADMIT</b>	Hospitalization starting date (format: <b>year/month/day</b> )
<b>BIRTH</b>	Patient date of birth (format: <b>year/month/day</b> )
<b>HEIGHT(cm/inch)</b>	Patient height (Increase/decrease by 0.5 cm or 0.5 inch per switch)
<b>WEIGHT(kg/lb)</b>	Patient weight (Increase/decrease by 0.5 kg or 0.5 lb per switch)

<b>BLOOD</b>	Patient blood type (Pick <b>A</b> , <b>B</b> , <b>O</b> , <b>AB</b> , or <b>N</b> . <b>N</b> represents unknown blood type)
<b>NEW PATIENT</b>	Admission of new patient

Also in this menu, the user may select “**NEW PATIENT**” item to access “**CONFIRM TO UPDATE PATIENT**” dialog box as shown below, in which the user decides whether to monitor a new patient.

**CONFIRM TO UPDATE PATIENT**

---

All data of currently monitored  
patient will be deleted. Yes?

---

Figure 4-4 Confirm to Update Patient

Pick **YES** to delete all information of the patient being currently monitored and exit the menu.

Pick **NO** to give up updating the patient and the system will keep the information of the current patient and exit the menu.

**NOTE:**

Selecting **YES** will delete all information about the currently monitored patient.

## 4.2 Default Setup

**NOTE:**

Select any item in this sub-menu to cancel the current setup and use the selected default setup.

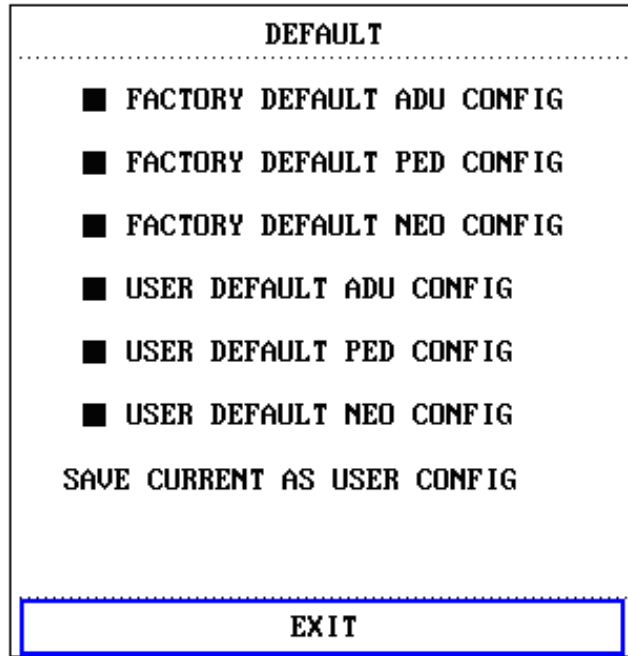

Figure 4-5 Default Menu

In this sub-menu, you can select the factory default or the user-defined default. Also in this sub-menu, you can save the current configuration as the user-defined default configuration. At this time, the system will automatically save all the setups in the parameter menu, ECG lead, gain and filter way as the user-defined default configuration according to the patient type. The dialog box as shown below will pop up.

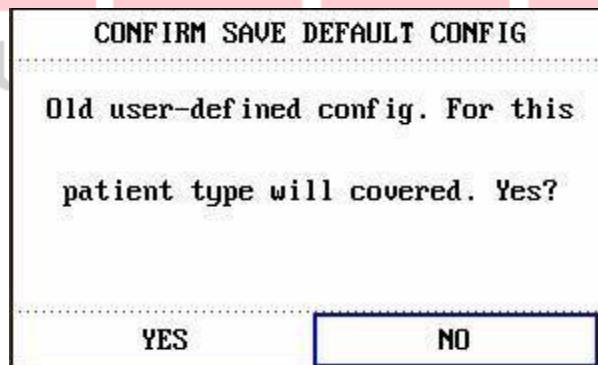

Figure 4-6 Confirm Save Default Configuration

Click on **YES** to save the current patient type configuration as the user default configuration. Click on **NO** to give up the operation.

### 4.3 Mark Event

There are four types of event that you can define.

Select **MARK EVENT** item in **SYSTEM SETUP** to call up the following menu:

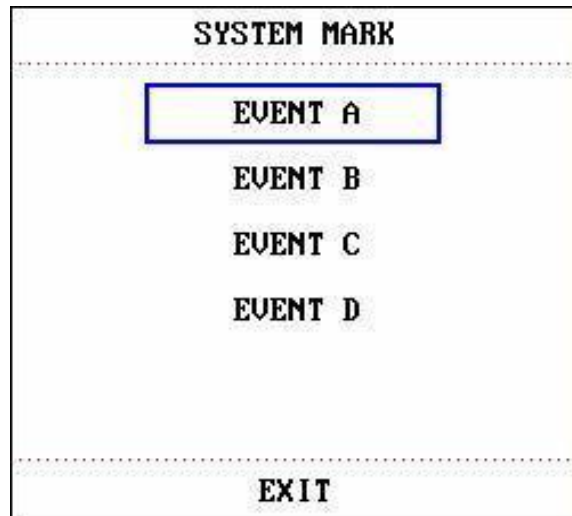

Figure 4-7 Mark Event

To mark the event: Use the rotary knob to select one from event **A**, **B**, **C** and **D**. There is a “@” signal for the one selected. To cancel your selection, repress the knob at selected item. Press **EXIT** to return to the previous menu.

The point of using event function:

To differentiate the patient events that have impact on parameter monitoring, such as dose taking, injection, therapy status, etc.

The Event will be displayed on the **Trend Graph** and **Trend Table** to assist analyzing patient parameter of the time when the event happens.

#### 4.4 Face Select

Select **FACE SELECT** item in **SYSTEM SETUP** menu to access **FACE SELECT** dialog box as shown below, in which four selections are available: **STANDARD SCREEN**, **TREND SCREEN**, **oxyCRG SCREEN** and **LARGE FONT SCREEN**. Only one selection can be chosen each time.

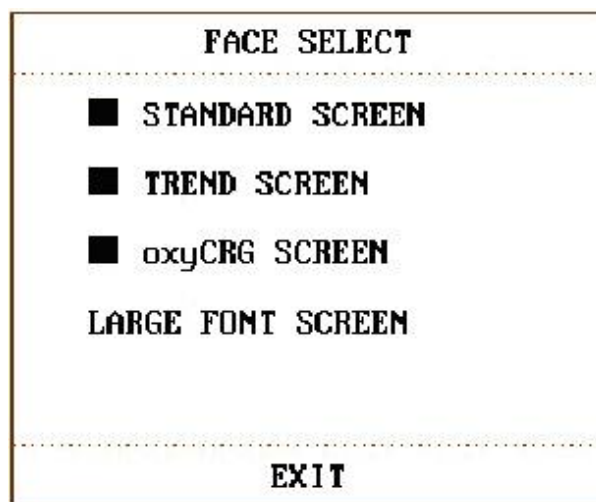

Figure 4-8 Face Select

After entering **LARGE FONT FACE SCREEN**, you can select three modes. See as follows:

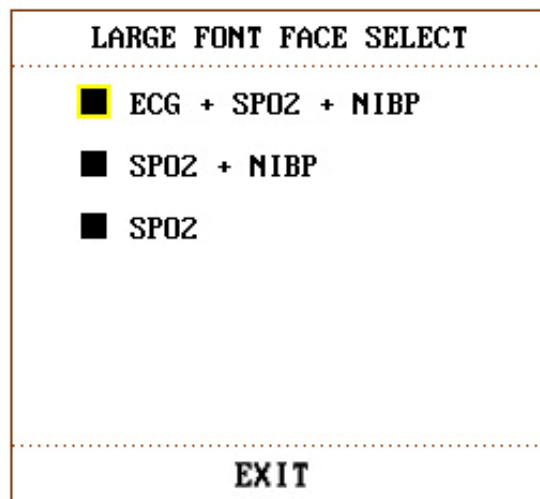
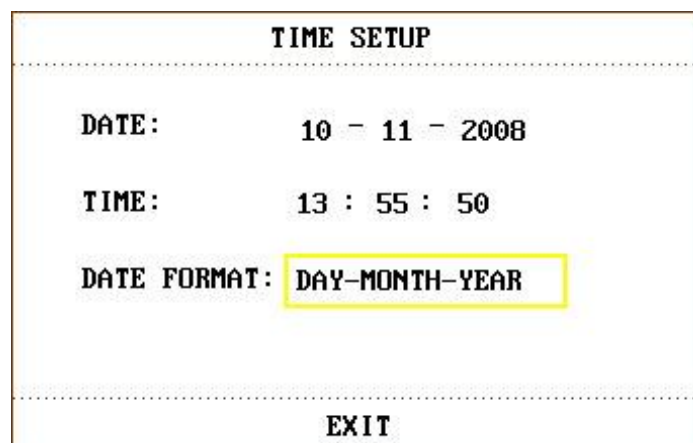
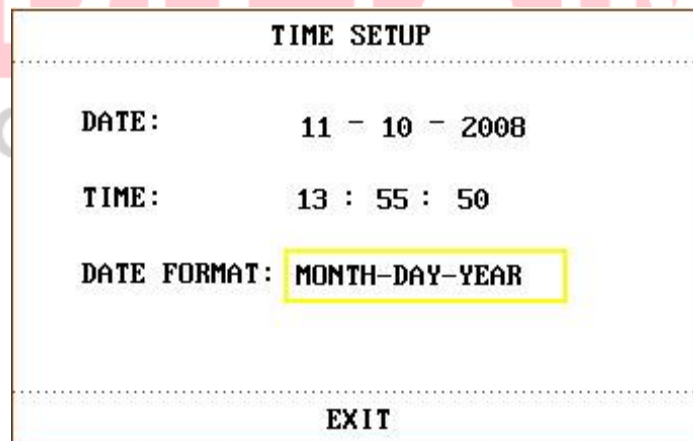

Figure 4-9 Large Font Face Select

## 4.5 Time Setup

Select **TIME SETUP** item in **SYSTEM SETUP** menu to access the sub-menu of **TIME SETUP** as shown below. System time is in the format of **MONTH-DAY-YEAR**, **DAY-MONTH-YEAR**, **YEAR-MONTH-DAY**. Pick the item and turn the knob to modify the items. Select **EXIT** item to return to the previous menu.





TIME SETUP	
DATE:	2008 - 11 - 10
TIME:	13 : 55 : 50
DATE FORMAT:	YEAR-MONTH-DAY
EXIT	

Figure 4-10 Time Setup

## 4.6 Record Setup

Select **RECORD** in **SYSTEM SETUP** menu to call up the following menu:

RECORD	
REC WAVE1	ECG1
REC WAVE2	ECG2
REC WAVE3	RESP
RT REC TIME	CONTINUAL
TIMING REC TIME	OFF
REC RATE	25.0
CLEAR REC TASK	
EXIT	

Figure 4-11 Record

In the sub-menu, the user may select the **REC WAVE1**, **REC WAVE2** or **REC WAVE3**, a maximum of 3 waveforms can be printed out.

The output waveforms can be selected for the following items:

<b>ECG1, ECG2, ECG3</b>	ECG1 waveform, ECG2 waveform and ECG3 waveform. (There will be 7 ECG waveforms on the screen in Full-Lead display mode). If no ECG waveform is currently displayed on the screen, this item cannot be picked.
<b>SpO<sub>2</sub></b>	SpO <sub>2</sub> Plethysmogram. (If no SpO <sub>2</sub> waveform is currently displayed on the screen, this item cannot be picked. In ECG Full-Lead display mode, this item can be picked, although no SpO <sub>2</sub> waveform is currently displayed on the screen. )

<b>RESP</b>	RESP waveform. (If no RESP waveform is currently displayed on the screen, this item cannot be picked. But in ECG Full-Lead display mode, this item can be picked, although no RESP waveform is currently displayed on the screen.)
<b>IBP1, IBP2</b>	IBP1 waveform and IBP2 waveform. (If no IBP waveform is currently displayed on the screen, this item cannot be picked. But in ECG Full-Lead display mode, this item can be picked, although no IBP waveform is currently displayed on the screen.)
<b>CO<sub>2</sub></b>	Display anesthetic gas waveforms or CO <sub>2</sub> module waveform. (If there is no CO <sub>2</sub> waveform on the screen, we cannot choose it. But in full screen multi-lead mode, we can choose it though we can not see it.)
<b>O<sub>2</sub></b>	Display anesthetic gas waveforms.
<b>N<sub>2</sub>O</b>	Display anesthetic gas waveforms.
<b>AA</b>	Stands for anesthetic agent waveform, replaced by anesthetic gas waveform on the screen.
<b>OFF</b>	No display for this channel.

- RT REC TIME:** represents “**real-time recording time**”, for which two selections are available: **CONTINUAL** and **8S** (8 seconds). “**CONTINUAL**” means once pressing the “**Record**” button on the front panel, the recorder will continuously print out the waveform or parameter until the “**Record**” button is pressed again.
- TIMING REC TIME:** represents “**time interval between two times of timing recording**”. 10 selections are available: “**OFF, 10MIN, 20MIN, 30MIN, 40MIN, 50MIN, 1HOUR, 2HOURS, 3HOURS** and **4HOURS**”. It means that the system will trigger the recording operation according to the selected time interval. The recording time is fixed at 8 seconds.

**NOTE:**

**REC TIME** has the higher priority compared with **TIMING REC TIME**.

- REC RATE:** 25.0 mm/s or 50.0 mm/s.
- CLEAR REC TASK:** this item can be used to stop recorder from printing out too many tasks.

**NOTE:**

- 1 The recorder is an optional part.
- 2 If two same waveforms are selected, one of them will change to a different waveform automatically.
- 3 When ECG waveforms are selected for printing, with gain of  $\times 1$ ,  $\times 0.5$  or  $\times 0.25$ ,

X0.125, a 3-channel waveform can be printed out; however, with gain of  $\times 2$ ,  $\times 4$ , only a 2-channel waveform can be printed out to avoid overlapping of waveforms, and the third waveform will be omitted.

- 4 The 3-channel waveform can be printed only in real-time recording, while it is not available in other recording modes, such as alarm review recording, and alarm triggered recording.

## 4.7 Module Setup

Select **MODULE SETUP** item in **SYSTEM SETUP** menu to call up the following menu:

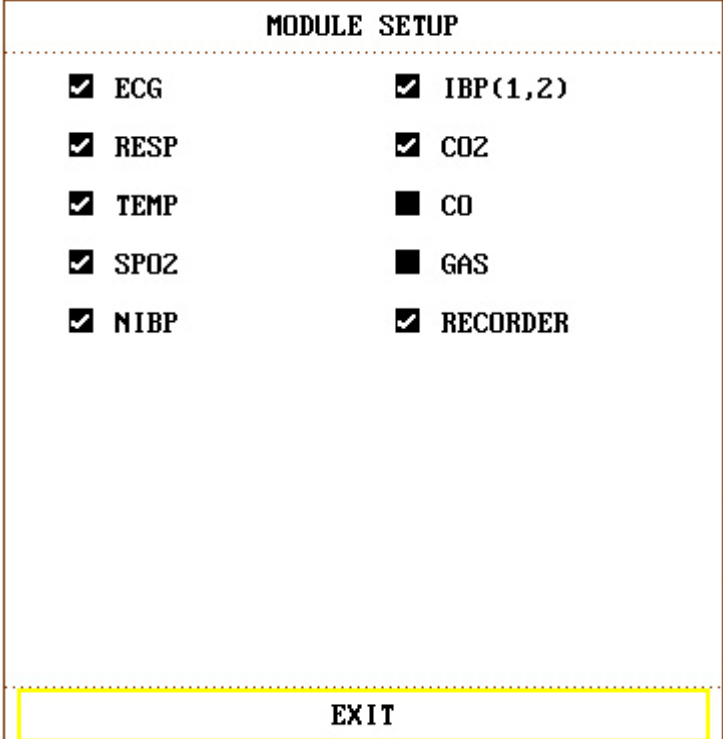

The screenshot shows a menu titled "MODULE SETUP" with a list of monitoring parameters. Each parameter has a checkbox to its left. The parameters are arranged in two columns. The first column includes ECG, RESP, TEMP, SPO2, and NIBP. The second column includes IBP(1,2), CO2, CO, GAS, and RECORDER. At the bottom of the menu, there is an "EXIT" option highlighted with a yellow border. The menu is displayed on a screen with a pink vertical bar on the left and a grey vertical bar on the right.

MODULE SETUP	
<input checked="" type="checkbox"/> ECG	<input checked="" type="checkbox"/> IBP(1,2)
<input checked="" type="checkbox"/> RESP	<input checked="" type="checkbox"/> CO2
<input checked="" type="checkbox"/> TEMP	<input type="checkbox"/> CO
<input checked="" type="checkbox"/> SPO2	<input type="checkbox"/> GAS
<input checked="" type="checkbox"/> NIBP	<input checked="" type="checkbox"/> RECORDER
<b>EXIT</b>	

Figure 4-12 Module Setup

You can choose the parameter you want to monitor from this menu, so that you can enhance the display efficiency, and avoid interference from other messages.

## 4.8 Tracing Waveforms Selection

Select **TRACE SETUP** item in **SYSTEM SETUP** menu to call up the following menu:

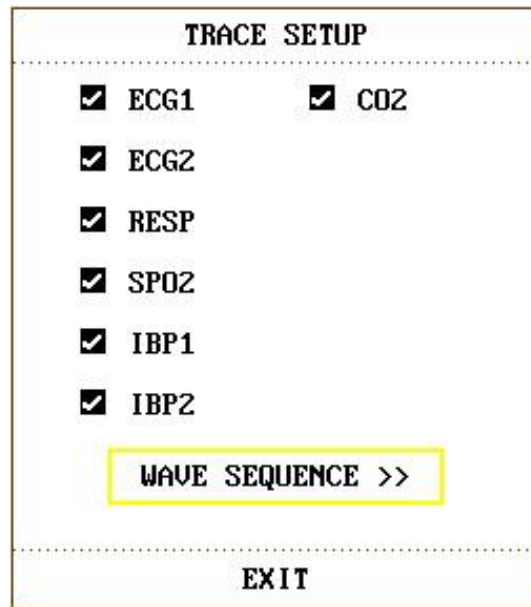

Figure 4-13 Trace Setup

You can define the traces displayed on the screen in this menu. The waveforms available for selection are those whose modules have been selected in **MODULE SETUP** menu.

## 4.9 Monitor Version

Pick **VERSION** to show the software version information of this monitor.

## 4.10 Alarm Volume

The system provides five levels of alarm volume and an alarm silence function. The system will give audio alarm prompt (except alarm sound) based on the selection.

The user may select different levels of volume as per clinical requirement. The method is listed below:

Press **ALARM SETUP** item in **SYSTEM SETUP** menu to call up **ALARM SETUP** sub-menu as shown below, in which the user may set up the alarm volume and other alarm information.

ALARM SETUP	
ALM SEL	COMMON ALM SETUP
ALARM VOL	3
ALM REC TIME	8S
EXIT	

Figure 4-14 Alarm Setup

- **ALARM VOL**: set the alarm volume by turning the knob. The valid range is from 1 to 10.
- **ALM REC TIME**: set to 8s, 16s or 32s.

You can also set alarm parameters in **MAINTAIN > USER MAINTAIN > ALARM SETUP**. Refer to *Chapter 6 Alarm* for details.

## 4.11 Key Volume

Select **SELECTION** item in **SYSTEM SETUP** menu to call up **SELECTION** sub-menu as shown below. Select **KEY VOL** item and set the volume. The selections are **OFF**, **LOW**, **MED**, **HIGH**.

SELECTION	
KEY VOL	MED
EXIT	

Figure 4-15 Selection

## 4.12 Drug Calculation

The monitor provides drug calculation and titration table display functions for fifteen different drugs. For details, please refer to the *Chapter 10 Drug Calculation and Titration Table*.

## 4.13 Waveform Demonstration

Select **DEMO** item in **SYSTEM MENU** to call up **INPUT DEMO KEY**. After entering the password, the system enters the Demonstration Waveform status.

The purpose of waveform demonstration is only to demonstrate the machine performance and for training purposes. In clinical applications, this function is not recommended because the **DEMO** will mislead the hospital personnel to treat the waveform and parameter as actual data of the patient, which may result in delay of treatment or mistreatment.

## 4.14 Maintenance

Select **MAINTAIN** item in **SYSTEM MENU** to open the **ENTER MAINTAIN PASSWORD** dialog box as shown below, in which you can enter password and then customize maintenance settings. Factory maintenance function is only available for the service engineers of EDAN or representatives authorized by EDAN.

ENTER MAINTAIN PASSWORD																				
USER KEY:								FACTORY KEY:												
								.....												
CONFIRM								CONFIRM												
A	B	C	D	E	F	G	H	I	J	K	L	M	N	O	P	Q	R	S	T	U
V	W	X	Y	Z	0	1	2	3	4	5	6	7	8	9		DEL	OK			
EXIT																				

Figure 4-16 Enter Maintain Password

### User Maintain

Input the password **A B C** into the **ENTER MAINTAIN PASSWORD** box and press **CONFIRM**, then the **USER MAINTAIN** menu will pop up, in which you can set up the following items.

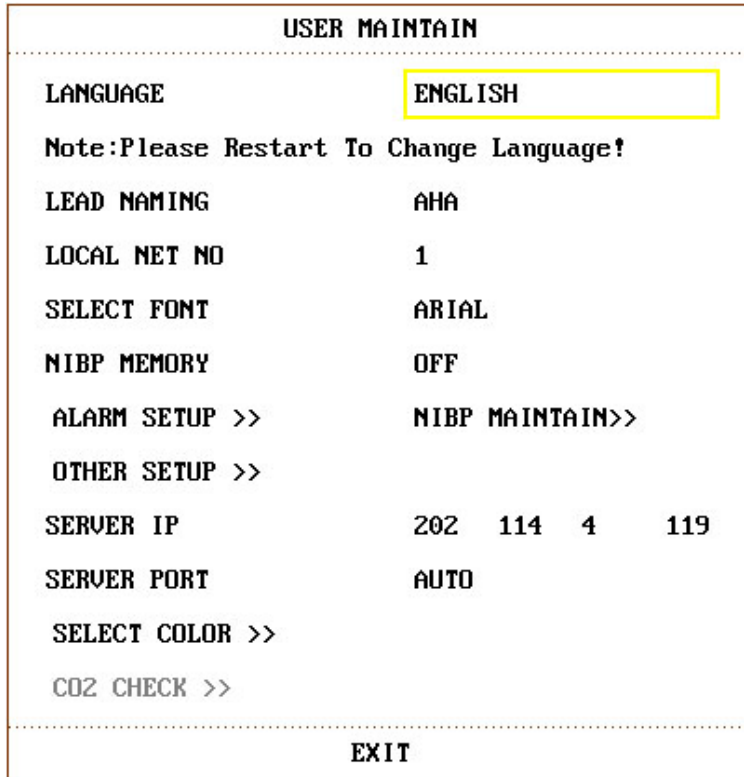

Figure 4-17 User Maintain

- 👁 **LANGUAGE:** You can set the language to be displayed on the interface.

**NOTE:**

Please restart the monitor after changing the language.

- 👁 **LEAD NAMING:** You can select **AHA** or **EURO** (IEC). To know the difference between these two styles, refer to *Chapter 12 ECG/RESP Monitoring*.
- 👁 **LOCAL NET NO:** Physical Number of monitor.
- 👁 **ALARM SETUP>>:** You can set up parameters of alarm. For more details refer to *Chapter 6 Alarm*.

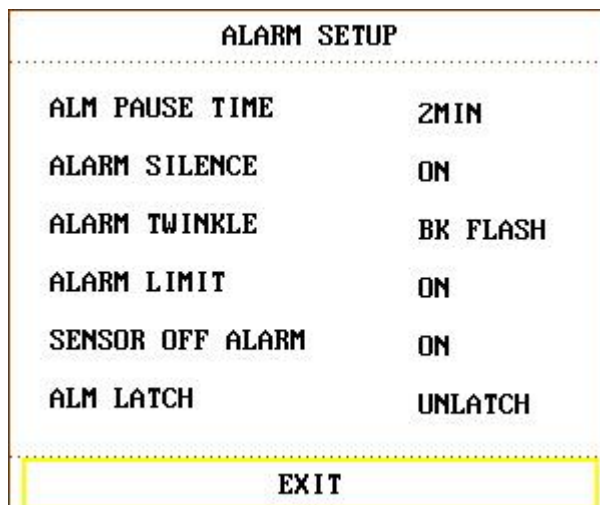

Figure 4-18 Alarm Setup

**SELECT FONT:** You can set the displayed font on the main screen to **ARIAL** or **ARIALBOLD**. The default is **ARIALBOLD**, the screen is displayed as follows:

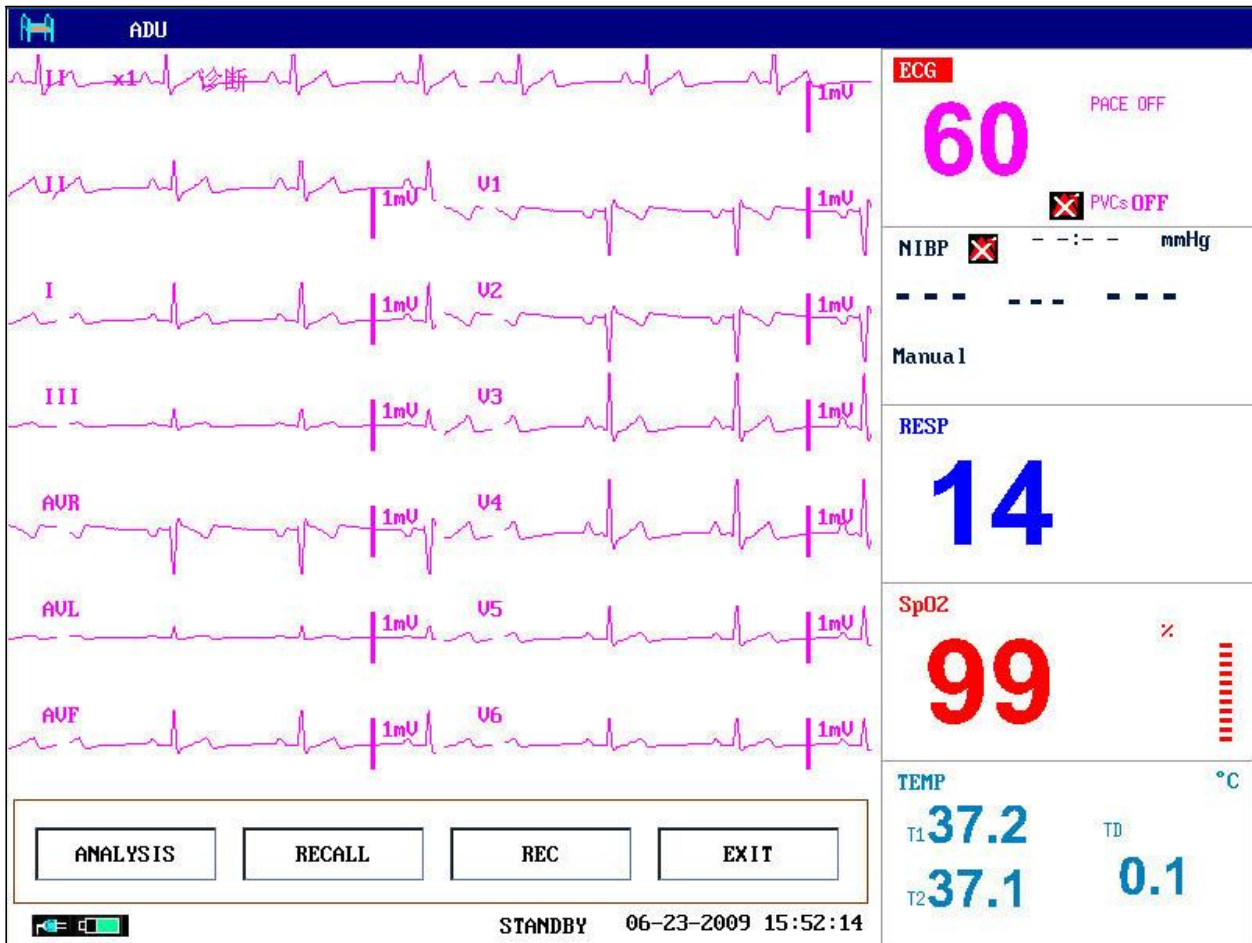

Figure 4-19 Select Arialbold display

**OTHER SETUP >>:** You can set some other functions. See as follows:

OTHER SETUP	
HUM TYPE	50HZ
HUM STATUS	ON
RESP DRIFT FILTER	ON
TEMP SENSOR	CY-F1
NURSE CALL	ON
<b>EXIT</b>	

Figure 4-20 Other Setup

**NURSE CALL:** Turn on or off the nurse call. When a new alarm of physiological



parameter occurs, it gives a 3-second **NURSE CALL** alarm; if the system alarm or the audio alarm is turned off, the **NURSE CALL** is unavailable. It is connected to RJ45 socket, the same port as connected to Ethernet. **NURSE CALL** occupies the 7<sup>th</sup> and 8<sup>th</sup> pins of RJ45. When the alarm occurs, the 7<sup>th</sup> and 8<sup>th</sup> pins are in short circuit: otherwise they are disconnected.

- ① **SERVER IP:** The default server IP is 202.114.4.119, it can be changed by the user according to the IP address of PC installed with MFM-CMS of the manufacturer.
- ① **SERVER PORT:** Set server port.
- ① **SELECT COLOR >>:** Users can set the displaying colors of waveforms by this item. 16 colors can be selected. Selecting **DEFAULT** can set the color configuration to default setup.

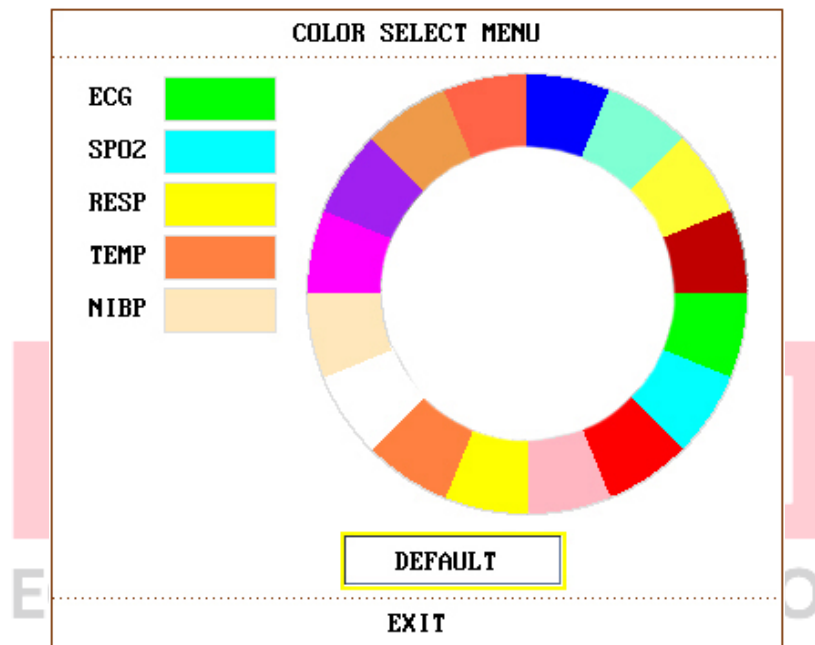

Figure 4-21 Color select menu

- ① **CO<sub>2</sub> CHECK >>:** For calibrating CO<sub>2</sub>.
- ① **GAS CALIBRATE >>:** For calibrating gas before AG monitoring. See as follows:



**DATA STORE:** set this item to **ON** or **OFF** to turn on or off the data store function. The data file will be stored into the folder of patient-data/patient ID in the USB storage; if the patient ID has not been set, the data will be stored into the default folder “**patient**” in USB storage.

Each data file is named by time, it can save 96-hour trend data with 1-min resolution, 1-hour trend data with 1-second resolution, 60 groups parameter alarm, 60 groups ARR data, 500 groups NIBP data, 120 seconds waveforms and patient information.

**EXIT U DISK:** users should exit the U disk via the menu before dismounting it.

After selecting **EXIT U DISK**, if the data is being stored, it will indicate “**Transmitting..., Please Waiting**”; if the U disk is dismounted successfully, it will indicate **EXIT U DISK SUCCESS**. After the USB icon vanishes, remove the U disk.

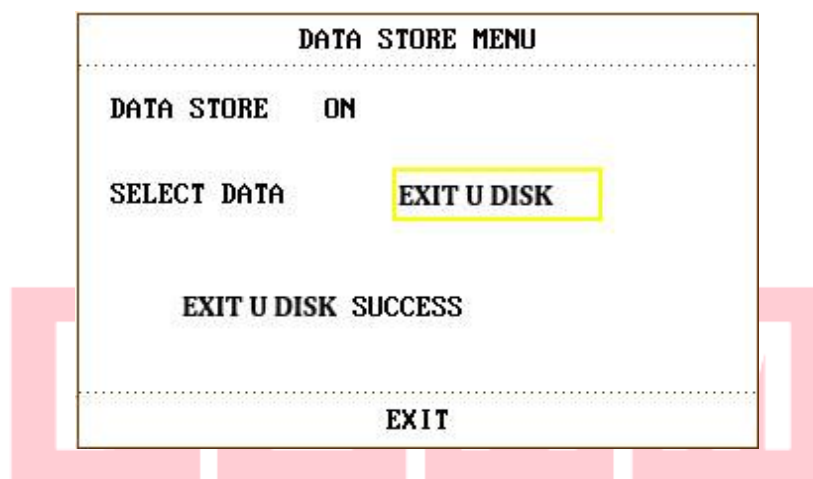

Figure 4-24 Delete USB success

**SELECT DATA:** select this item to query data. The dialog box displays as follows:

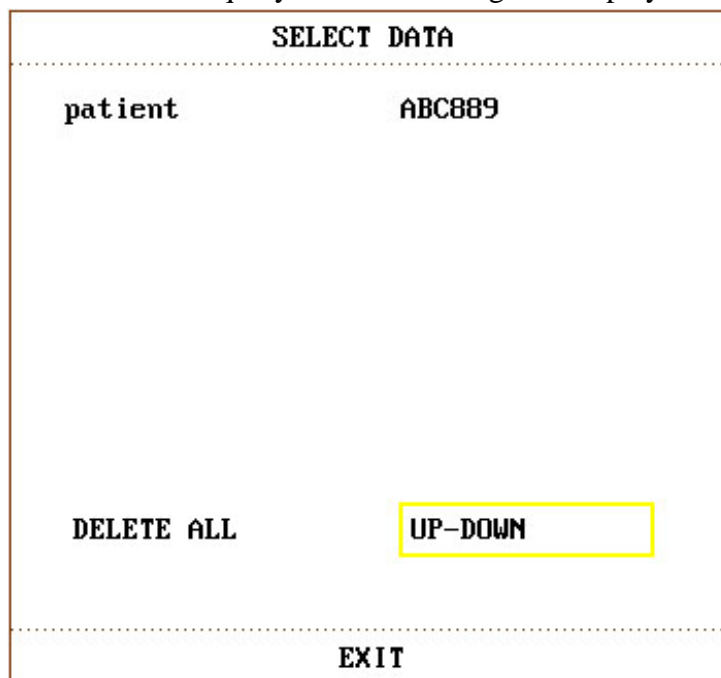

Figure 4-25 Select data

- **DELETE ALL:** users can delete all the data of selected patient ID by this item.

- **UP-DOWN**: users can page up or down by this item, patient ID can be displayed on few pages.

Select patient ID to enter the following dialog box for selecting the data:

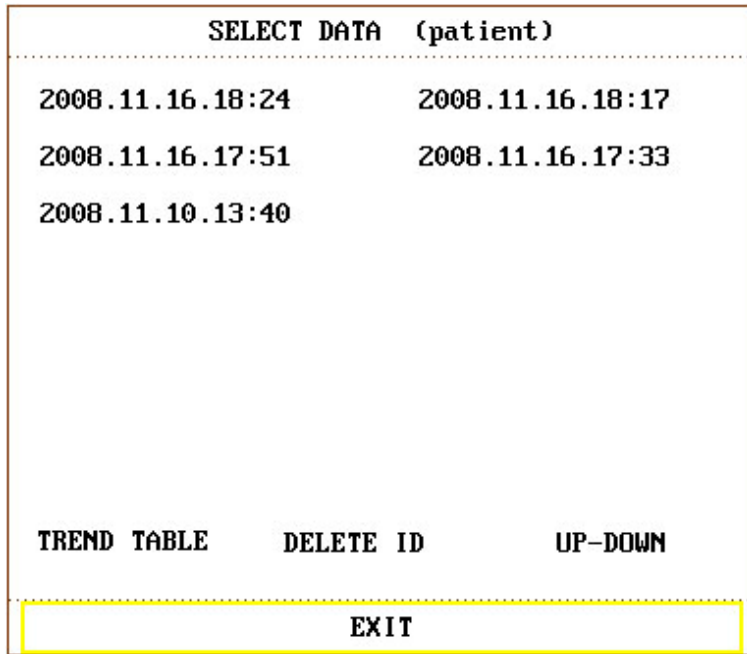

Figure 4-26 Select data

After selecting the time, the data will be imported from the USB storage to the monitor, it indicates as follows:

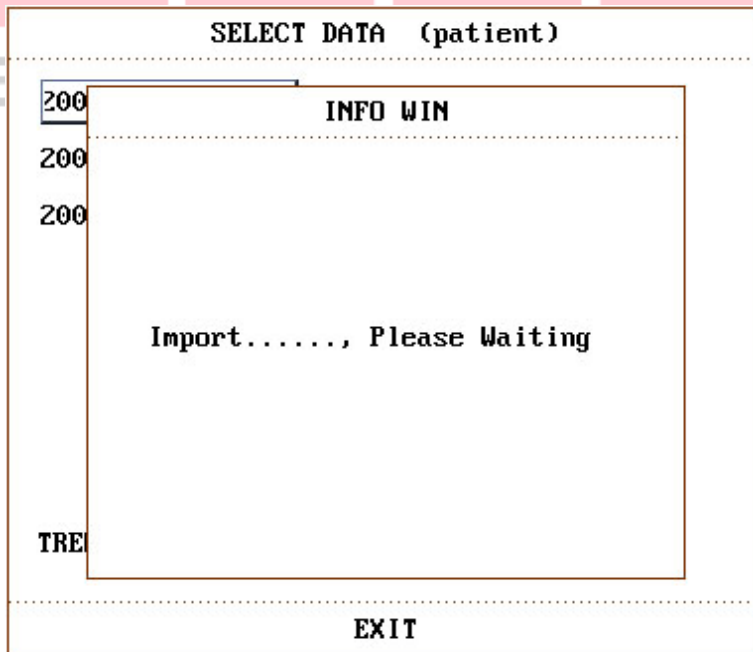

Figure 4-27 Importing data

- **TREND TABLE**: users can select this item by rotary knob after importing data, the real line box becomes broken line box, select the following contents to display: **TREND TABLE**, **TREND GRAPH**, **NIBP RECALL**, **PATIENT INFO**, **FREEZE RECALL**, **ARR**

**RECALL or ALARM LIST.**

- **DELETE ID:** users can delete all the data for current ID by this item. The dialog box displays:

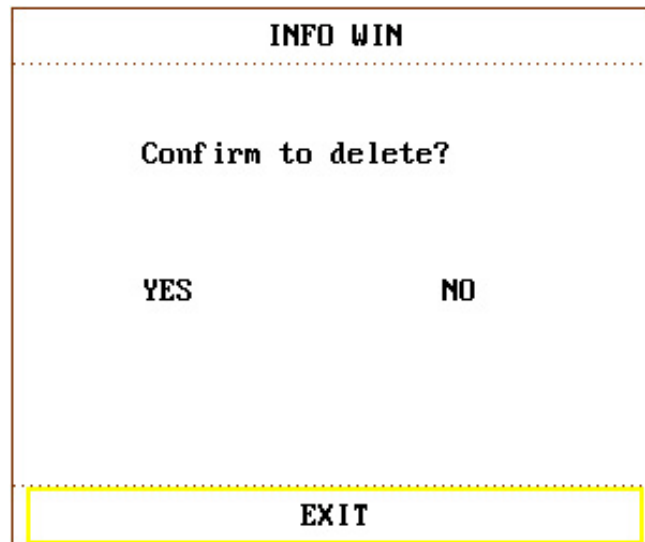

Figure 4-28 Confirm to delete

After deleting successfully, it indicates **DELETE SUCCESS!**

**NOTE:**

The data of the current monitoring patient ID can not be deleted.

If the data has not been saved successfully because of the power supply off or USB storage off, when the users queries data by **SELECT DATA**, the prompt pops up:

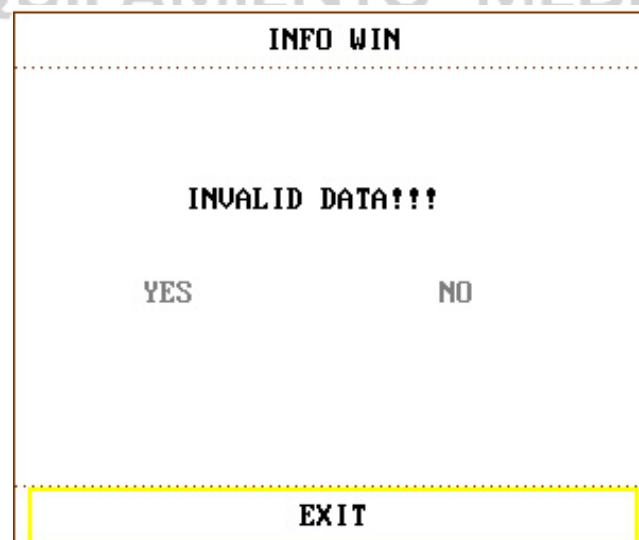

Figure 4-29 Invalid data!!!

If the user wants to query or delete data before selecting data, the prompt will pop up:

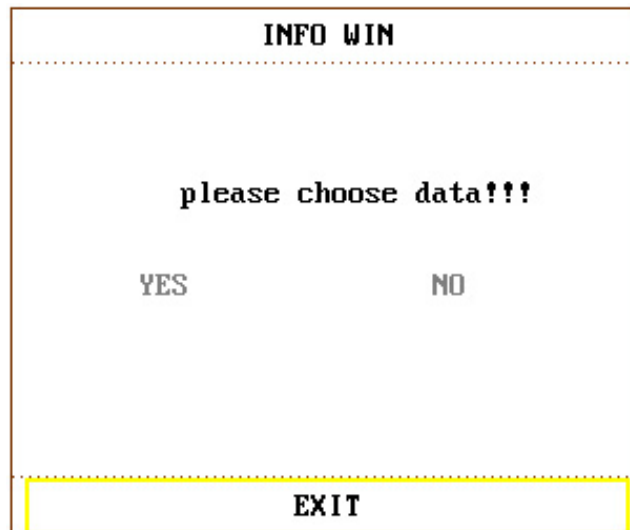

Figure 4-30 Please choose data

If the USB storage is full, it indicates **NO SPACE IN USB STORAGE** on the screen.

NOTE :

- 1 Data store function can be set to on or off in **FACTORY MAINTAIN** by the manufacturer or the representative permitted by EDAN.
- 2 Remove USB disc before deleting may damage the USB storage or loss data.

**EDAM**  
EQUIPAMIENTO MEDICO

## Chapter 5 Face Select

This monitor has four different operating screens, which are **Standard Screen**, **Trend Screen**, **oxyCRG Screen** and **Large Font Screen**. Users can select different operating screens for necessary information as requested.

### 5.1 Selecting Operating Screen

In the **SYSTEM MENU**, select the **FACE SELECT** option in the **SYSTEM SETUP** menu to call up the dialog box as shown in the figure below. There are four options in this dialog box, which are **STANDARD SCREEN**, **TREND SCREEN**, **oxyCRG SCREEN** and **LARGE FONT SCREEN**. Only one item can be selected at a time.

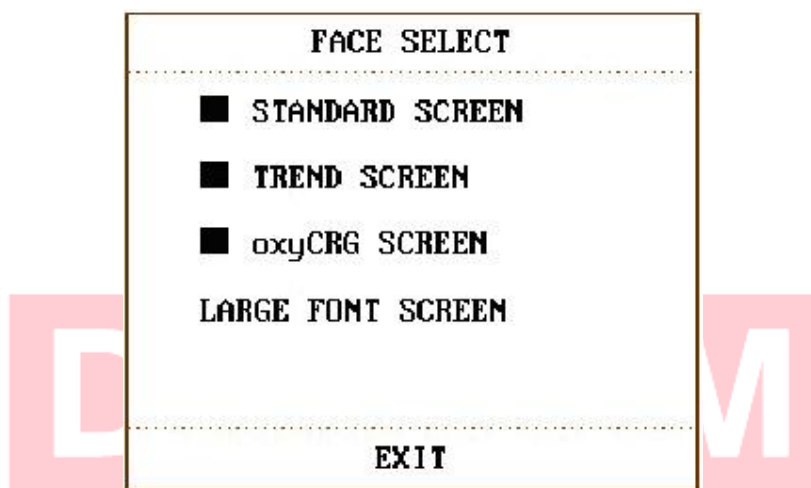

Figure 5-1 Face Select

### 5.2 Standard Screen

In the **FACE SELECT** menu, select the **STANDARD SCREEN** option to enter the Standard Screen. The Standard Screen displays to us the parameters in the Parameter area and the waveforms being monitored. This screen is the basic operating screen of the monitor.

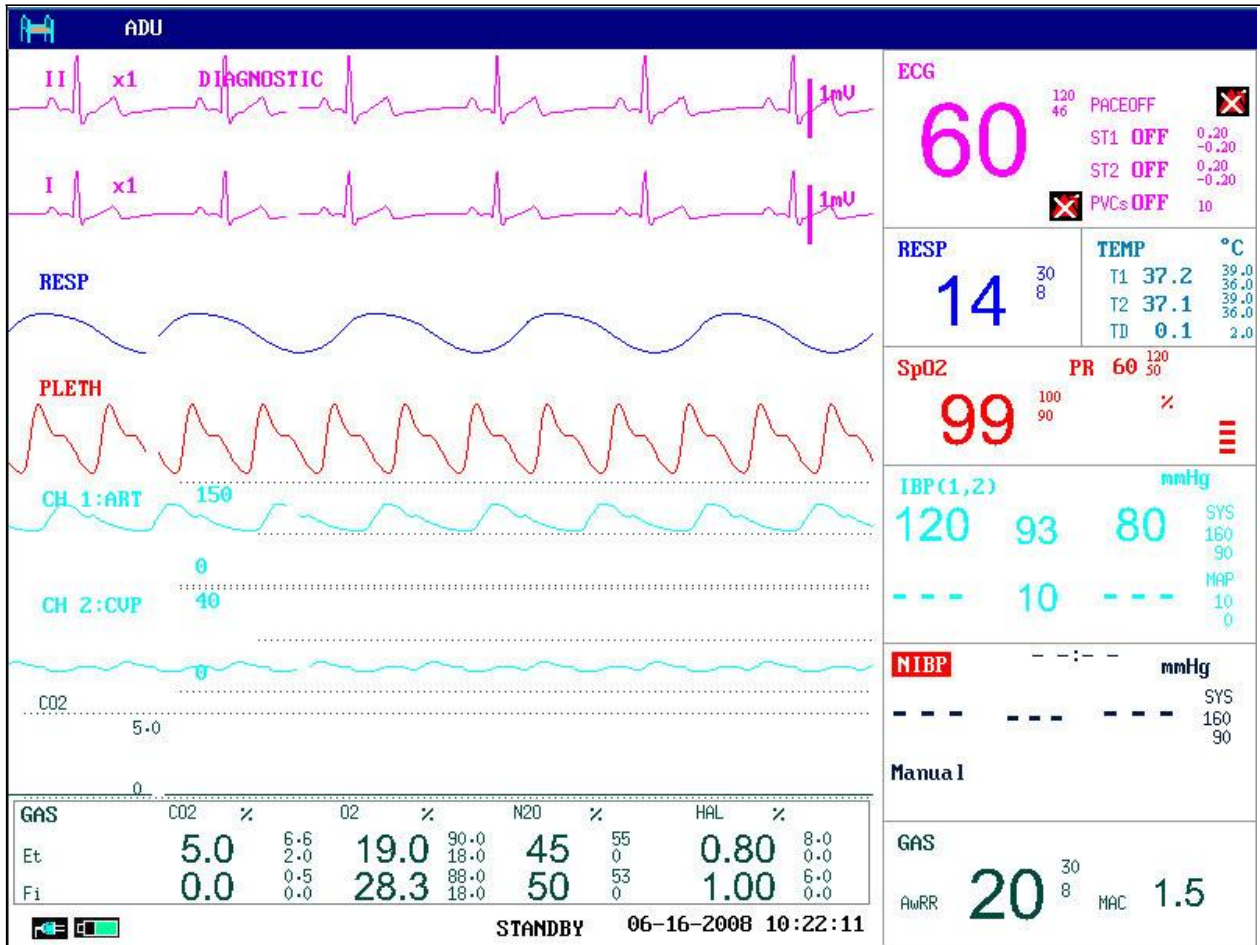

Figure 5-2 Standard Screen

### 5.3 Trend Screen

#### 👁 Entering **TREND SCREEN**

In the **FACE SELECT** menu, select the **TREND SCREEN** option to enter the Trend Screen.



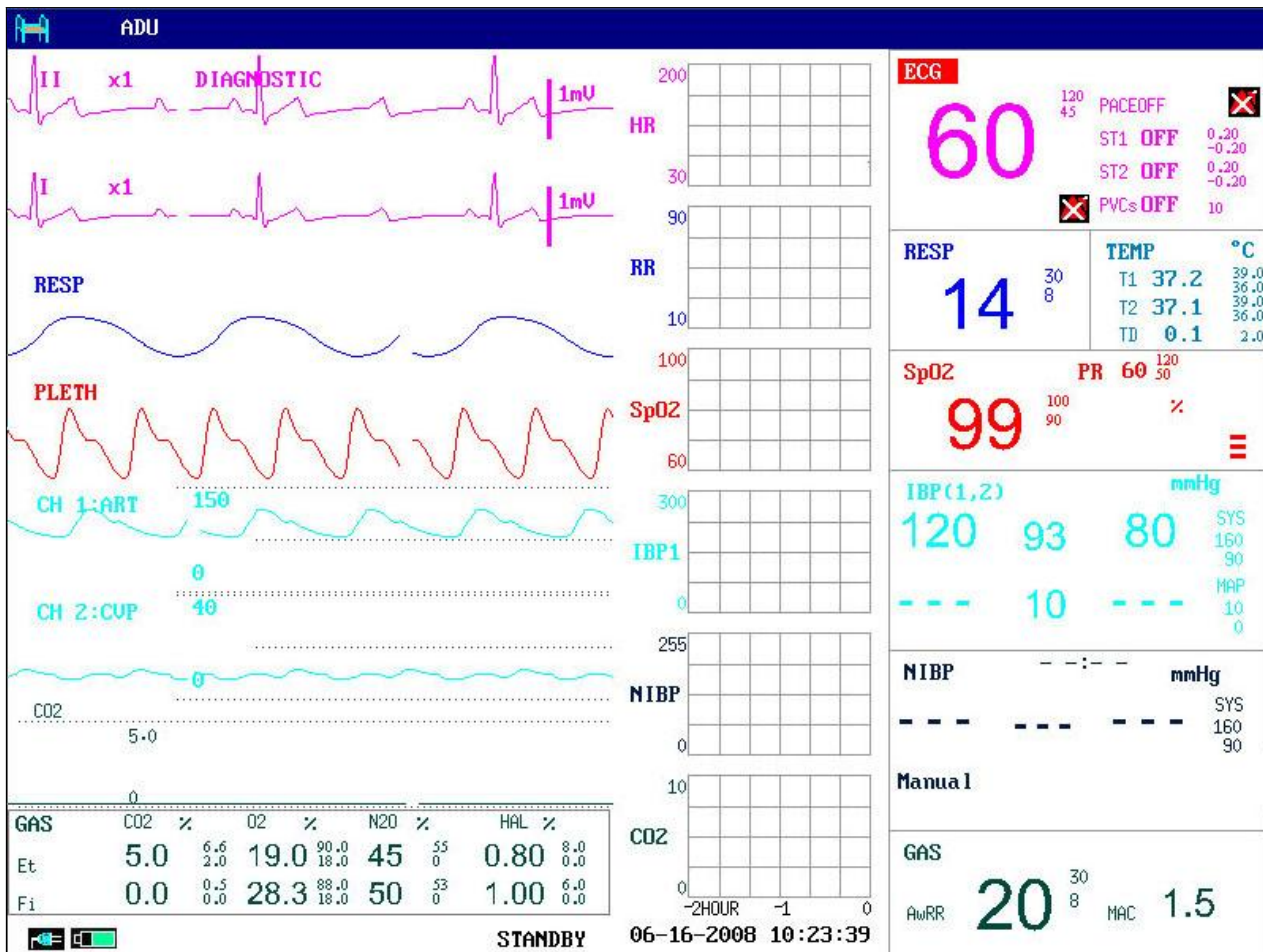

Figure 5-3 Trend Screen

Position of trend graph

Trend graph is located on the right of the corresponding waveform in the Waveform area. Its color is the same as that of the corresponding parameter.

Trend length

Dynamic trend length is 2 hours. On the trend graph, the scale of the right end of the X-axis is 0 hour while the left end is 2-hour.

Select trend parameter

If multiple parameters are located at the same position on the trend graph, by selecting the corresponding hot key of a parameter on the trend graph, you can have the trend graph of this parameter displayed on the screen. For example, on ECG trend graph, you can select hot keys such as HR, ST or PVCs, then the system will display their corresponding trend graphs respectively.

Close trend screen

In the **FACE SELECT** menu, select options of other operating screens to close the **Trend Screen**.

## 5.4 oxyCRG Screen

**👁** Enter oxyCRG SCREEN

In the **FACE SELECT** menu, select the **oxyCRG SCREEN** option to enter the oxyCRG Screen.

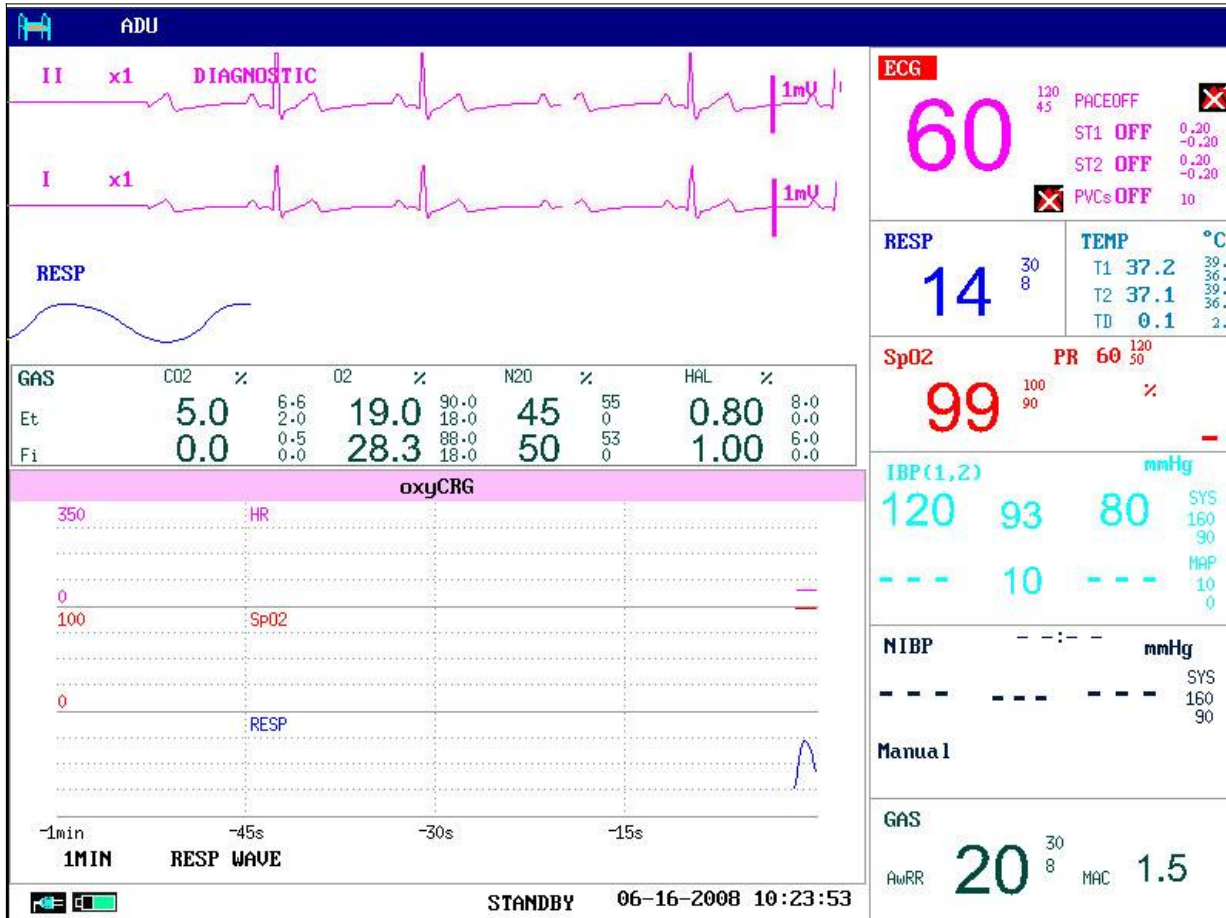

Figure 5-4 oxyCRG Screen

**👁** Trend graph of oxyCRG screen

Located at the lower part of the screen, oxyCRG screen consists of three trends: HR Trend, SpO<sub>2</sub> Trend and RR Trend or Compressed Resp. Waveform.

**👁** Select oxyCRG trend length

There are two hot keys at the bottom part of the oxyCRG Screen, which are **4MIN/2MIN/1MIN** and **RR/RESP WAVE**.

By using hot keys for trend time, you may select to display trend graphs of three different lengths, i.e., 1 min, 2 min and 4 min.

**👁** Select RR trend or Compressed RESP Waveform

By using the hot keys for **RR/RESP WAVE**, you may select either RR trend graph or compressed Resp. Wave. They occupy the same position. Therefore, if you select “RR”, the position displays the dynamic trend of RR. If you select **RESP WAVE**, the position displays the compressed Resp. Wave.

👁️ Close oxyCRG

In the **FACE SELECT** menu, select options of other operating screens to close the oxyCRG Screen.

## 5.5 Large Font Screen

Large Font Screen is a kind of operating screen, just like Standard Screen, Trend Screen and other operating screens. It is used by customers to meet different display requirements in monitoring.

👁️ Enter Large Font Screen

Choose **LARGE FONT SCREEN** in **FACE SELECT** menu to enter **LARGE FONT FACE SELECT**. There are three modes, see as follows:

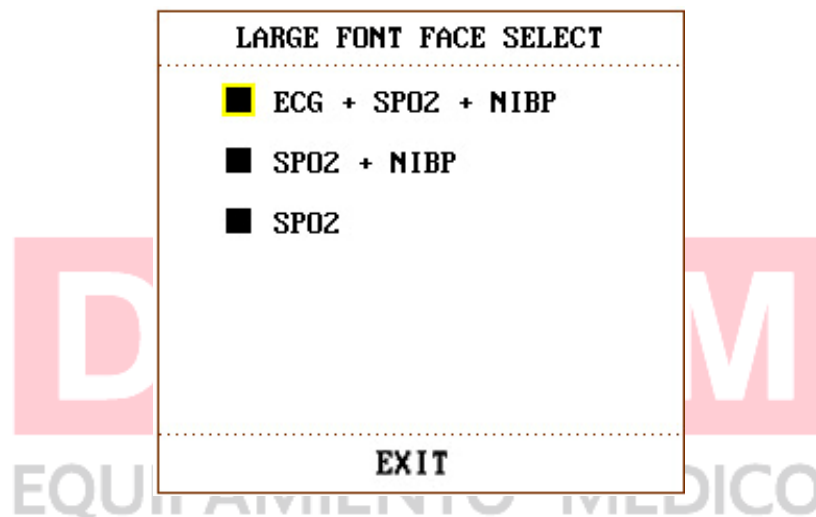

Figure 5-5 Large Font Face Select

👁 Three display modes

1. ECG+SpO<sub>2</sub>+NIBP display mode:

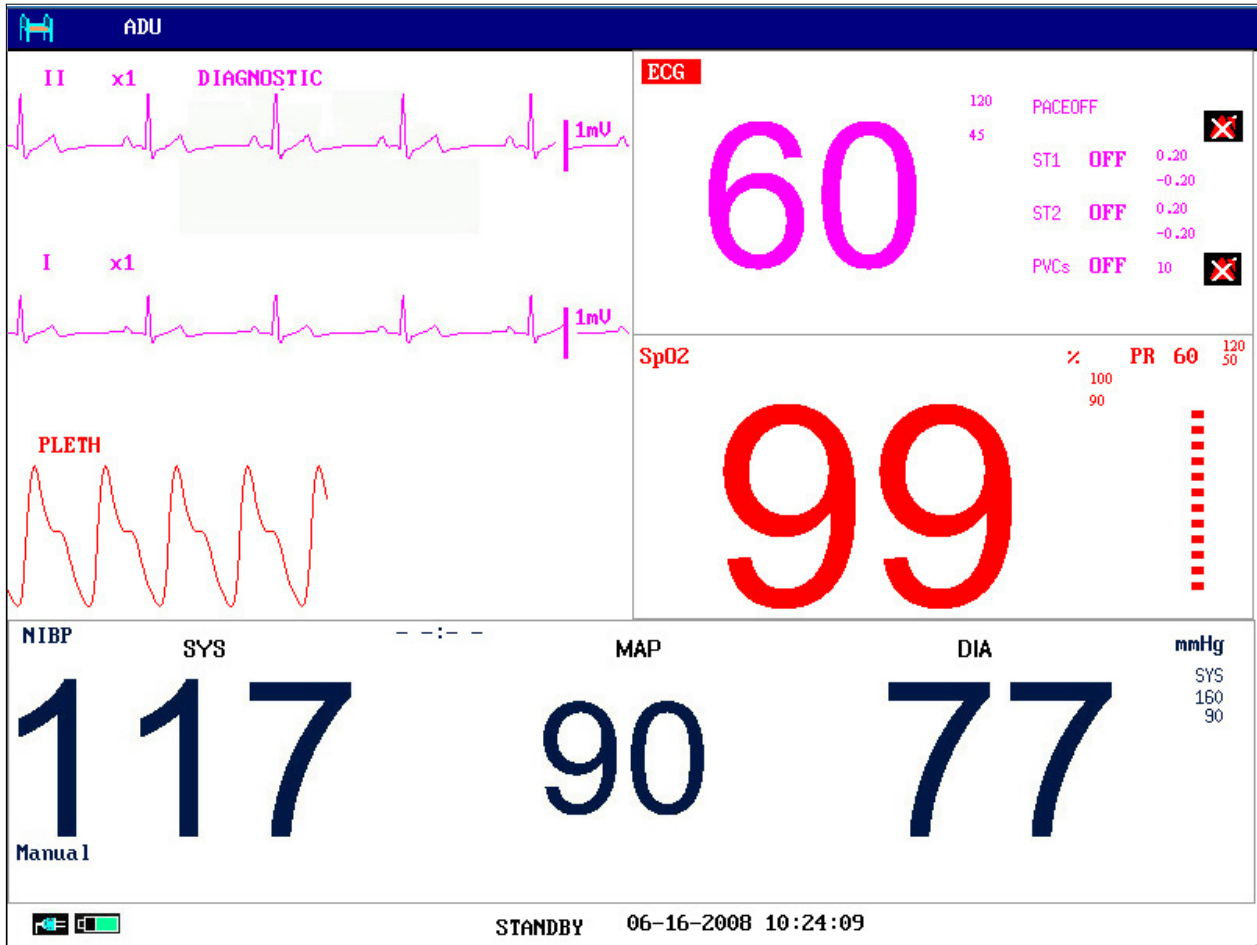
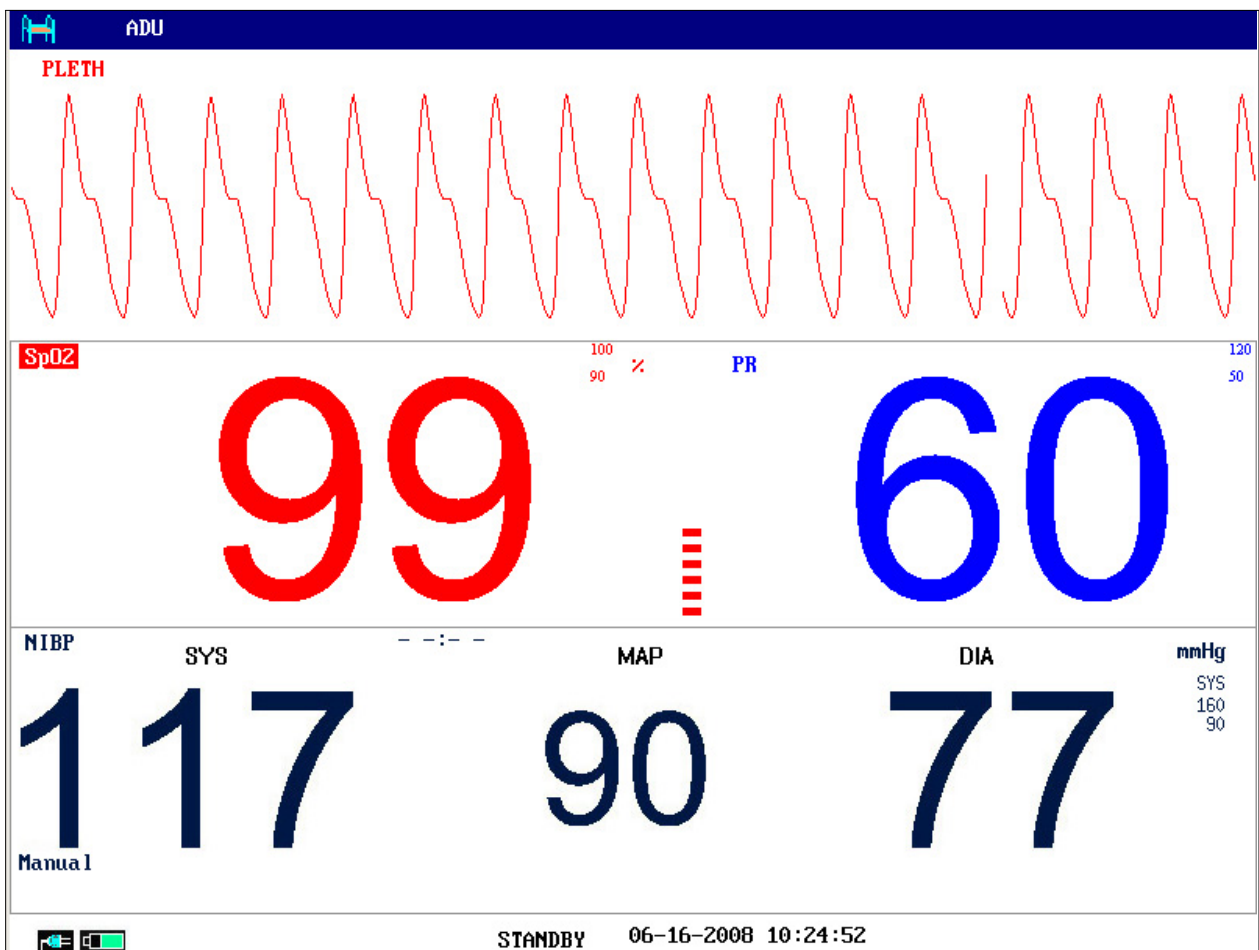

Figure 5-6 ECG+SpO<sub>2</sub>+NIBP display mode

2. SpO<sub>2</sub>+NIBP display mode:



EQUIPAMENTO MEDICO Figure 5-7 SpO<sub>2</sub>+NIBP display mode

3. SpO<sub>2</sub> display mode:

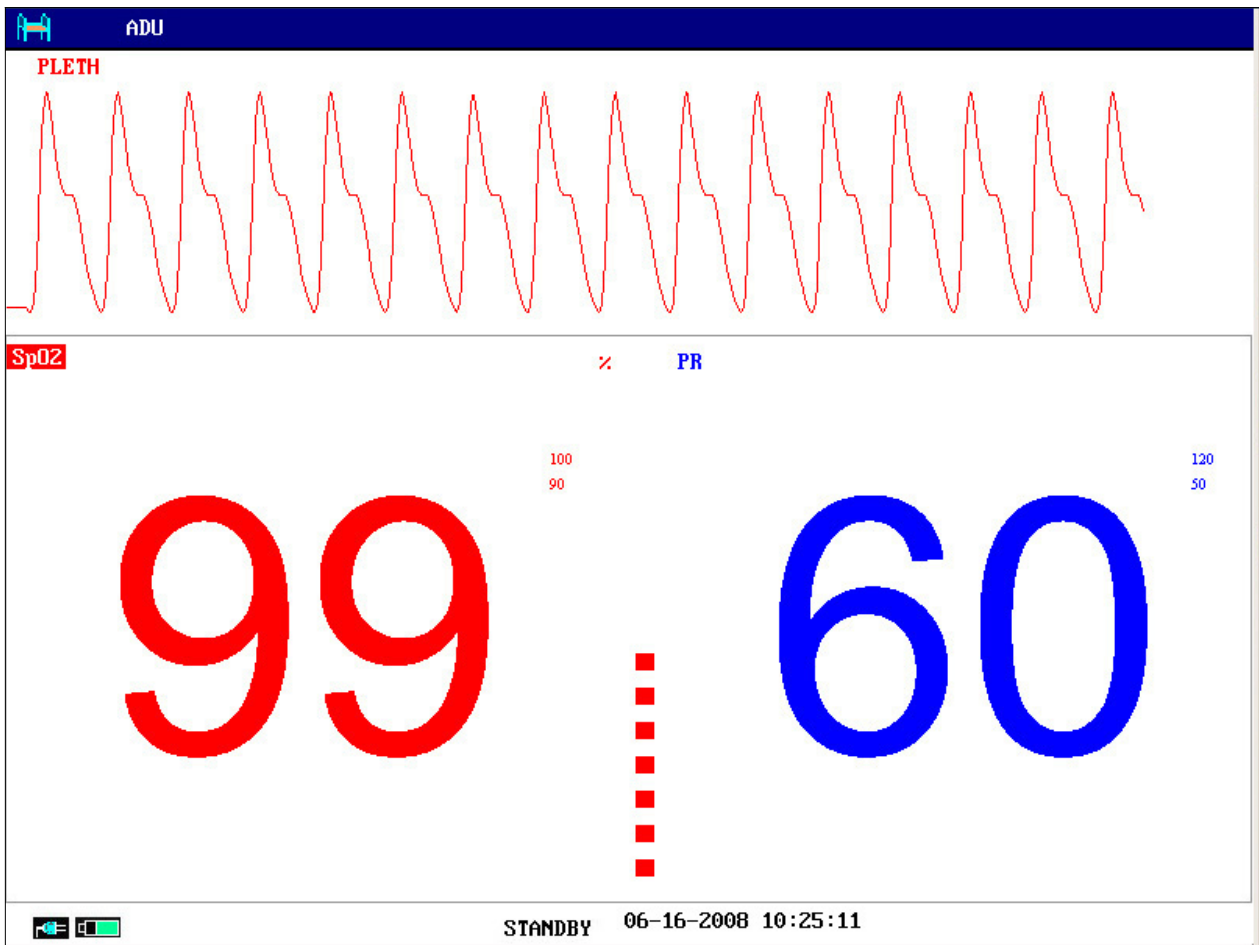

EQUIPAMIENTOS MEDICO  
Figure 5-8 SpO<sub>2</sub> display mode

👁 Exit Large Font Screen

In the **LARGE FONT FACE SELECT** menu, choose **EXIT** to return to **FACE SELECT** screen.

## Chapter 6 Alarm

This chapter gives general information about the alarm and measures to be taken accordingly. Alarm setup and prompt messages are provided in respective parameter setup sections.

### 6.1 Alarm Modes

#### 6.1.1 Alarm Level

Each alarm, either technical or physiological, has its own level. For alarms of higher levels, when the alarm condition is active, the system will give an alarm prompt in various ways. Some alarm's level can be set by the user via software. Others can not be changed once defined by the system. Alarms in the monitor are divided into three levels, that is, high, medium and low.

A high-level alarm indicates the patient's life is in danger or the monitor in use has serious technical problems. It is the most serious alarm.

A medium-level alarm means a serious warning.

A low-level alarm is a general warning.

Alarms are classified into three categories, which are physiological alarms, technical alarms and general alarms. Physiological alarms refer to those alarms triggered by patient's physiological situation which could be considered dangerous to his or her life, such as heart rate (HR) exceeding alarm limit (parameter alarms). Technical alarms refer to system failure which can make certain monitoring process technically impossible or make monitoring result unbelievable. Technical alarms are also called System Error Message. General alarms belong to those situations that can not be categorized into these two cases but still need to be paid some attention.

The monitor has pre-set the alarm level for the parameters. You can also modify the alarm level using the method described in this chapter.

Alarm level of the System Error Message (technical alarm) is pre-set in the system.

All technical alarm levels and general alarm levels, some of the physiological alarm levels are pre-set in the system and can not be changed by users.

#### 6.1.2 Alarm Modes

When alarm condition is active, the monitor can raise the user's attention in at least three ways, which are audio prompt, visual prompt and description. Audio prompt is given by the speaker, and visual prompt is given by TFT display device and alarm indicator light. Description is displayed on the screen. Physiological alarm is displayed in the Physiological Alarm area. Most of technical alarms are displayed in the Technical Alarm area. Technical alarms related to NIBP measurement are displayed in the NIBP Technical Alarm area at the bottom of NIBP parameter area.

#### NOTE:



- 1 The Physiological Alarm area is on the upper right part of the screen. The Technical Alarm area is on the left side of the Physiological Alarm area.

- 2 If the monitor is connected to the external alarm prompt system (e.g. the alarm speaker and indicator are connected onto the rear panel of the monitor), when alarm condition is active, the external alarm prompt system responds in the same way as the monitor.
- 3 The concrete presentation of each alarm prompt is related to the alarm level.

#### **How to indicate that the measured parameter has exceeded its alarm limits:**

When physiological alarm of the monitored parameter exceeds the alarm limit, besides using the above-mentioned three ways to give the alarm prompt, the monitor also gives alarm by making the font or the background of monitored parameter flash in the frequency of 1Hz (refer to *Chapter 6.1.3 Alarm Setup*).

The icons for parameters exceeding the alarm limits:

Alarm level	Icon
High	
Medium	
Low	

#### **Screen Display**

When the measured parameter exceeds its alarm limits and triggers a physiological alarm, the corresponding parameter value will flash. “\*” signal appears on the screen indicating the occurrence of an alarm. Red “\*\*\*” indicates a high-level alarm, yellow “\*\*\*” indicates a medium-level alarm, and yellow “\*” indicates a low-level alarm. Technical alarms will not prompt “\*” signal.

#### **Lamp Light**

The high/medium/low-level alarms are indicated by the system in following different visual ways:

Alarm level	Visual prompt
High	Alarm indicator flashes in red with high frequency.
Medium	Alarm indicator flashes in yellow with low frequency.
Low	Alarm indicator lights on in yellow.

#### **Alarm Sound**

The high/medium/low-level alarms are indicated by the system in following different audio ways:



Alarm level	Audio prompt
High	Mode is “DO-DO-DO-----DO-DO, DO-DO-DO-----DO-DO”, which is triggered once every 5 seconds.
Medium	Mode is “DO-DO-DO”, which is triggered once every 20 seconds.
Low	Mode is “DO-”, which is triggered once every 25 seconds.

**NOTE:**

- 1 The monitor does not have alarm condition delay or alarm signal generation delay.
- 2 When alarms of different levels occur at the same time, the monitor prompts the one of the highest level.
- 3 If the monitor is powered off and then turned on, the alarm setup can resume to the setup which is set before the power-off.

### 6.1.3 Alarm Setup

#### Setup alarm in the ALARM SETUP menu

Press the **ALARM SETUP** button in the **SYSTEM SETUP** menu to call up **ALARM SETUP** menu (default menu) as shown below. In the **ALM SEL** item, the user may set up the information about common alarm setup and the alarm setup of each parameter.

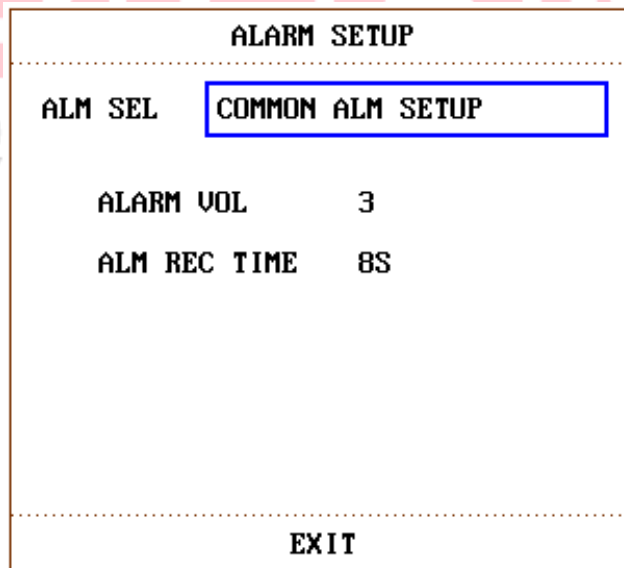

Figure 6-1 Alarm Setup

**👁️ COMMON ALM SETUP**

Select **COMMON ALM SETUP** option in **ALM SEL** item. This operation may call up the dialog box as the default one.

- 👁️ **ALARM VOL:** set the alarm volume by this item, the valid range is from **1** to **10**.
- 👁️ **ALM REC TIME:** this item can be set to **8S**, **16S** and **32S**.

### 👁 Alarm setup of each parameter

In the **ALARM SETUP** menu, select the **ALM SEL** item to set up the alarm information for the following parameters. They are **HR, ST, PVCs, SpO<sub>2</sub>, NIBP, IBP (1, 2), RESP, TEMP, CO<sub>2</sub>, CO** and **GAS**. For example:

#### 👁 Method to set up HR alarm information:

Step 1: Select the **HR ALM SETUP** option in the **ALM SEL** item. Then the menu only displays HR setup items.

Step 2: You can set up five items in this menu, which are **HR ALM** (on/off of the alarm switch), **ALM LEV** (alarm level), **ALM REC** (alarm recording switch), **ALM HI** (higher limit of HR alarm), **ALM LO** (lower limit of HR alarm). You can move the cursor onto the item to be setup by using the knob and press the knob to make the setup.

The method for setting the alarm information of other parameters is the same as HR.

### Setup alarm in the User Maintain menu

You can also set up alarm parameters in **SYSTEM MENU > MAINTAIN > USER MAINTAIN > ALARM SETUP**. See as follows:

ALARM SETUP	
ALM SILENCE TIME	2MIN
ALARM SILENCE	ON
ALARM TWINKLE	BK FLASH
ALARM LIMIT	ON
SENSOR OFF ALARM	ON
ALM LATCH	UNLATCH
EXIT	

Figure 6-2 Alarm Setup in User Maintain

- 👁 **ALM SILENCE TIME:** Set up the duration of Alarm Pause status, it can be set to 1 minute, 2 minutes and 3 minutes.
- 👁 **ALARM SILENCE:** When it set to **ON**, hold the **Silence** button on the front panel for 3 seconds, and the alarm system will be silenced. In the alarm silence mode, the monitor gives a Low alarm for the silence state per 3 minutes. Press this button again to turn on the alarm system.
- 👁 **ALARM TWINKLE:** Set it to **FONT FLASH** or **BK FLASH**. When the measured parameter exceeds the alarm limit, the monitor gives an alarm by font flash or background flash.

**FONT FLASH:** When the measured parameter exceeds its alarm limits, the font of the parameter and the alarm limit flashes. For example, if the parameter exceeds high alarm

limit, the parameter and the high alarm limit flash at the same time.

**BK FLASH:** When the measured parameter exceeds its alarm limits, the background of the parameter and the alarm limit flash. For High alarm, the background flashes in red; for Medium alarm, and the background flashes in yellow; for Low alarm, the background displays in yellow without flash.

- 👁️ **ALARM LIMIT:** Set it to **ON** or **OFF**. When it is set to **ON**, the alarm limits for every parameter will be displayed beside the parameter on main interface.

There are a few differences for displaying NIBP and IBP alarm limits:

- When alarm condition is not active, the alarm limits of **SYS** are displayed on the interface;
- If one of the three parameters (**SYS, MAP, DIA**) of NIBP or IBP is in alarm condition, the alarm limits of it will be displayed on interface.
- If the three parameters are all in alarm condition, the monitor will display the alarm limits of **SYS**; if two of them in alarm conditions, the parameters are displayed according to their priorities. The priority from high to low is **SYS, MAP, DIA**.

- 👁️ **SENSOR OFF ALARM:** Turn on or off the sensor off alarm. When this item is set to **ON**, pressing the **SILENCE** button on the front panel can pause the audio alarm. Press again to resume the audio alarm; when the alarm is in pause state, it will give an alarm if sensor off alarm condition is active.

- 👁️ **ALM LATCH:** Users can set it to **LATCH** or **UNLATCH**.

If it is set to **LATCH**, when alarm occurs, the monitor will give an audio prompt and a light prompt (the **FONT FLASH** and **BK FLASH** are not active). After this alarm event is over, for example, the measured parameters resume to normal conditions, the monitor will still give the alarm prompt continuously. Press the **Silence** button or set **UNLATCH** in menu to stop this alarm prompt.

When it is set to **UNLATCH**, when alarm occurs, the monitor will give an audio prompt and a light prompt (the **FONT FLASH** and **BK FLASH** are not active). Different from the **LATCH** mode, after this alarm event is over, the monitor will stop giving the alarm prompt.

## 6.2 Alarm Cause

An alarm occurs when:

1. A physiological alarm is evoked;
2. An alarm for error of the system (technical alarm) is evoked;
3. A general alert occurs.

- 👁️ **A. Conditions that activate the parameter alarms:**

The measurement value exceeds the alarm limit and the alarm is set to **ON**.

- 👁️ **B. Conditions that activate the system alarms (technical alarm):**

Upon the system error, the monitor prompts an alarm immediately.

### **👁 C. General alert**

In some circumstances, alerts will behave as physiological alarms. But in normal sense, we do not regard them as real patient health related items.

## **6.3 Silence**

Enter **SYSTEM MENU > MAINTAIN > USER MAINTAIN > ALARM SETUP**. If the **ALARM SILENCE** is set to **ON**, press **Silence** button to turn off the audio alarm or pause it.

### **1. Audio alarm paused icon**

When the **ALARM SILENCE** is **ON**, press **SILENCE** button on front panel, then the audio alarm is paused. And the paused time can be set in **ALARM SETUP** menu, see figure 6-2. The audio alarm paused icon displays beside the parameter. Press **SILENCE** button again can resume the audio alarm.

### **2. Audio alarm off icon**

Press and hold the **SILENCE** button for more than 3 seconds, and then the audio alarm is turned off. Then pressing **SILENCE** button again or hold it for a few seconds can turn on the audio alarm. In the audio alarm off state, the monitor gives a low alarm beep per 3 minutes to prompt that the alarm is turned off.

#### **NOTE:**



Whether an alarm will be reset depends on the status of the alarm cause.

## **6.4 Parameter Alarm**

The setup for parameter alarms is in their menus. In the menu of a specific parameter, you can check and set the alarm limit and alarm status. The setup is isolated from each other. The setup alarm limit will be displayed beside each parameter.

When a parameter alarm is off, a symbol  displays beside the parameter. If the alarms are turned off separately, they must be turned on separately.

For the parameters whose alarms are set to **ON**, the alarm will be triggered when at least one of them exceeds the alarm limits. The following actions take place:

1. Alarm message displays on the screen as described in alarm mode;
2. The monitor beeps in its corresponding alarm class and volume;
3. Alarm lamp flashes;
4. The icons for parameters exceeding the alarm limits will display beside parameters. The icon for Medium or Low alarm is , while for High alarm is .

## 6.5 When an Alarm Occurs

**NOTE:**

When an alarm occurs, you should always check the patient's condition first.

The alarm message appears on the top right side of the screen. You need to identify the alarm and act appropriately, according to the cause of the alarm.

1. Check the patient's condition.
2. Identify the cause of the alarm.
3. Identify which parameter is alarming or which alarm is happening.
4. When the cause of the alarm has been found out, check that the alarm is working properly.

You will find the alarm messages for the individual parameter in their appropriate parameter chapters of this manual.



## Chapter 7 Freeze

### 7.1 General

When monitoring a patient, you may freeze the waveforms of interest so as to view them carefully. Generally you can review a frozen waveform of a maximum of 12 minutes. The Freeze function of this monitor has the following features:

- 🕒 Freeze status can be activated on any operating screen;
- 🕒 Once entering the Freeze status, the system exits all other operating menus. Besides, the system freezes all waveforms in the Waveform area of the Basic Screen, and also freezes Full Lead ECG waveforms and extra waveforms on the Full Lead ECG interface (if any). Nevertheless the Parameter area refreshes normally.
- 🕒 The frozen waveforms can be reviewed and recorded.

### 7.2 Entering/Exiting Freeze Status

#### 🕒 Enter Freeze Status

In the Non-Freeze status, press the **FREEZE** button on the control panel of the monitor to let the system exit the Menu being currently displayed (if available), then enter the Freeze status and display the popup **FROZEN** menu. In the Freeze status, all other waveforms are frozen. In other words, the system will no longer refresh all other waveforms.

#### 🕒 Exit Freeze Status

In the Freeze status, executing any of the following operations will command the system to exit the Freeze status:

- 🕒 Select the **EXIT** option in/from the **FROZEN** menu;
- 🕒 Press the **FREEZE** button on the control panel again;
- 🕒 Press the non-immediate-to-execute button (for example, once a button is pressed, a menu will pop up for you to further select an option) on the front panel and system buttons of Menu and Main;
- 🕒 Execute any operation that may trigger the adjustment of the screen or the display of a new menu.

After exiting the Freeze status, the system will discharge the Freeze status, clear screen waveforms and resume display real-time waveforms. In the Screen Refresh mode, the system will sweep the waveforms from left to right in the Waveform Area.

### 7.3 FROZEN Menu

Press the **FREEZE** button on the control panel, and the **FROZEN** menu will appear on the bottom part of the screen. At the same time, the system enters the Freeze status.

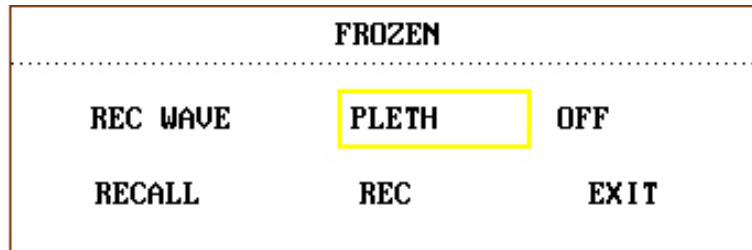

Figure 7-1 Frozen

- 👁️ **REC WAVE:** it can be set to any waveform of 8s, such as **IBP1**, **CO<sub>2</sub>**, **PLETH** etc. It can also be set to **OFF**.
- 👁️ **RECALL:** Used to review frozen waveforms.
- 👁️ **REC:** select this item to record the setting waveform in **REC WAVE**.
- 👁️ **EXIT:** After this button is pressed, the system closes the **FROZEN** menu and exits the Freeze status.

**NOTE:**

Pressing the **FREEZE** button repeatedly in a short period of time may result in discontinuous waveforms displaying on the screen.

## 7.4 Reviewing Frozen Waveform

By moving the waveform, you may review a waveform of 12 minutes before it is frozen. For a waveform of less than 12 minutes, the remaining part is displayed as a straight line. Use the rotary knob on the control panel to move the cursor to the **RECALL** option in the **FROZEN** menu. Press the knob. By turning the knob left or right, frozen waveforms on the screen will move left or right correspondingly. There is an arrow indicating upward on the right side of the last waveform. There is also a time scale beside the arrow. “-0S” is used to mark the moment when waveforms are frozen. With waveforms moving right, this time mark will in turn change into -1S, -2S, -3S... These time marks are applied to all waveforms on the screen.





## Chapter 8 Recording (Optional)

- 👁 General information on recording
- 👁 Instructions for configuring and recording
- 👁 Recording messages

### 8.1 General Information on Recording

A thermal dot matrices recorder with 48mm wide printout paper is used for the monitor.

#### Performance of the Recorder

- 👁 Waveform record is printed out at the rate of 25 mm/s or 50 mm/s.
- 👁 It can record up to three waveforms.
- 👁 English printout.
- 👁 User-selectable real-time recording time and waveform.
- 👁 Auto recording interval is set by the user, and the waveform is in accordance with the real time recording.

#### NOTE:

It is suggested that the user should not use the recorder when the low battery displays, or the monitor may be turned off automatically.

### 8.2 Recording Type

The monitor provides several types of stripe recording:

- 👁 Continuous real-time recording
- 👁 8 second real-time recording
- 👁 Auto 8 second recording
- 👁 Alarm recording
- 👁 Frozen waveform recording
- 👁 Trend graph, trend table recording
- 👁 Arrhythmia review recording
- 👁 Drug calculation titration recording
- 👁 NIBP review recording
- 👁 Alarm review recording
- 👁 CO measurement recording
- 👁 Hemodynamic Calculation result recording
- 👁 oxyCRG recording

#### NOTE:

- 1 When ECG waveforms are selected for printing, with gain of  $\times 1$ ,  $\times 0.5$  or  $\times 0.25$ , a 3-channel waveform can be printed out; however, with gain of  $\times 2$ , only a 2-channel waveform can be printed out to avoid overlapping of waveforms, and the third waveform will be omitted.

- 2 The 3-channel waveform can be printed only in real-time recording, while it is not available in other recording modes, such as alarm review recording and alarm triggered recording.

### Real-time Recording

Real-time recording starts as you press the **RECORD** button on the recorder.

The waveforms for continuous real-time recording and continuous 8 second recording are automatically set by the monitor (usually the first three waveforms displayed on the screen). You can also configure it through the menu. Refer to related section for details.

In **RECORD** menu, the user can choose three waveforms to be printed out. The user can set up one or two waveforms to be off. Thus, the real time record will print out one or two waveforms. If three waveforms are off, the real time record will print out measure parameters only.

#### NOTE:

The system can start executing the next alarm recording task only when the current one is finished.

### Auto Recording

The monitor starts the recorder for every 8 seconds according to the time interval set in the **TIMING REC TIME** of the **RECORD** menu. Refer to *Chapter8 Recording Setup* for details.

### Alarm Recording

#### 👁 Parameter Alarm

The monitor records waveforms 4, 8, or 16 seconds prior to and after the alarm (totally 8, 16 or 32 seconds) (which can be selected in **SYSTEM MENU**). All parameter values during the alarm will also be recorded.

When a parameter alarm occurs, two recorded waveforms can be printed out.

In order to avoid repeated printout of alarm waveforms:

- ① If more than two parameter alarms are switched on and triggered simultaneously, the recorder will print out that of the highest level. If they are of the same alarm level, the latest alarm will be printed out.
- ② If an alarm occurs during the alarm of another parameter, it will be printed out after the current recording is finished.
- ③ If many alarms occur at the same time, some of waveforms will be stored for printout in turn.

#### 👁 ST Segment Alarm

The monitor records 2-channel ECG waveforms 4, 8, or 16 seconds prior to and after the alarm (totally 8, 16 or 32 seconds) (which can be selected in the **ECG SETUP** menu). All parameter values during the alarm will also be recorded.

#### 👁 Arrhythmia Alarm

The monitor records 2-channel ECG waveforms 4, 8, or 16 seconds prior to and after the alarm (totally 8, 16 or 32 seconds). All measurement results during the alarm will also be recorded.

## Titration Table

The monitor can print out the message in the current **TITRATION** window.

### Notes on Recording

👁 Recording types:

Real time Report

Periodic Report

Para Alarm Report

Titration Table

Arrhythmia Report

Freeze Wave Report

Trend graph

Trend table

Para Alarm Review

NIBP Test Review

CO Test Review

#### HEMOCAL PARAMETERS

👁 Patient bed number, name, sex, height, weight, date of birth, admission date

👁 Parameter name and value

👁 Recording time

👁 Waveform name

👁 Waveform scale (for ECG waveform)

👁 ECG lead, scale, filter mode, (if there are ECG waveforms, they will be printed out within the first second or when changing the lead, gain and filter mode during real-time recording.)

👁 IBP scale (the first second of IBP waveform)

👁 CO<sub>2</sub> scale (the first second of CO<sub>2</sub> waveform)

👁 Date and time.

## 8.3 Recording Startup

You can start the recording in the following ways:

Continuous real-time recording	Press the <b>RECORD</b> button to start/stop the recording.
8 second real-time recording	Press the <b>RECORD</b> button to start recording. It will automatically stop in 8 seconds.
Auto recording	Record the three waveforms selected in <b>RECORD</b> menu according to the setup time interval in <b>RECORD</b> menu. It will automatically stop in 8 seconds.

Alarm recording	When alarm recording is set to <b>ON</b> , it automatically starts when alarm occurs.
Trend graph recording	Access the <b>TREND GRAPH</b> menu, and then press the <b>RECORD</b> button to start recording.
Trend table recording	Access the <b>TREND TABLE</b> menu, then press the <b>RECORD</b> button to start recording.
Arrhythmia review recording	Enter the <b>ECG SETUP</b> menu via hot key, select <b>ARR ANALYSE &gt; ARR RECALL</b> , then press the <b>RECORD</b> button to start recording.
Alarm review recording	Access the <b>ALARM RECALL</b> menu, then press the <b>RECORD</b> button to start recording.
NIBP review recording	Access the <b>NIBP RECALL</b> menu, then press the <b>RECORD</b> button to start recording.
Titration table recording	Access the <b>DRUG CALC</b> menu from the <b>SYSTEM MENU</b> . Pick the <b>TITRATION</b> button in the menu to access the <b>TITRATION</b> window. Pick the <b>REC</b> button to print out the titration currently displayed in the window.
Frozen waveform recording	8-second frozen waveform can be recorded, 2 waveforms are selectable.

**NOTE:**

- 1 You can press the **RECORD** button on the control panel to stop the current recording process.
- 2 When ECG waveforms are selected for printing, with gain of  $\times 1$ ,  $\times 0.5$  or  $\times 0.25$ ,  $\times 0.125$ , a 3-channel waveform can be printed out; however, with gain of  $\times 2$ ,  $\times 4$ , only a 2-channel waveform can be printed out to avoid overlapping of waveforms, and the third waveform will be omitted. The 3-channel waveform can be printed only in real-time recording, while it is not available in other recording modes, such as alarm review recording, and alarm triggered recording.

Access the **RECORD** menu from the **SYSTEM SETUP** menu. Then pick the **CLEAR REC TASK** button to stop all recording tasks.

## 8.4 Recorder Operations and Status Messages

### Record Paper Requirement

Only standard thermosensitive record paper can be used: otherwise the recorder may not function, the recording quality may be poor, and the thermosensitive printhead may be damaged.

### Proper Operation

- When the recorder is working, the record paper goes out steadily. Do not pull the paper outward with force: otherwise the recorder may be damaged.
- Do not operate the recorder without record paper.

### Paper Out

When **RECORDER OUT OF PAPER** alarm is displayed, the recorder cannot start. Please insert record paper properly.

### Inserting Paper

- Pull outwards the upper arc part of the recorder casing to release the casing.
- Insert a new roll of paper into the paper cassette, printing side facing upwards.
- Ensure proper position and tidy margin.
- Pull about 2cm of the paper out, and close the recorder casing.

### NOTE:

Be careful when inserting papers. Avoid damaging the thermo-sensitive print head. Unless when inserting papers or shooting troubles, do not leave the recorder catch open.

### Removing Paper Jam

When the recorder functions or sounds improperly, you should open the recorder casing to check for a paper jam. Removing the paper jam in the following way:

- Cut the record paper from the feeding edge.
- Open the recorder casing.
- Re-insert the paper.

### NOTE:

If the monitor is not installed with a recorder, it will indicate **NO RECORDER** after pressing the **RECORD** button.



## Chapter 9 Trend and Event

The monitor provides 96-hour trend data of all parameters, storage of 500 NIBP measurement results and 60 alarm events. This chapter gives detailed instruction for review of all data.

### 9.1 Trend Graph

- 👁 The latest 1-hour trend is displayed every 1 or 5 seconds;
- 👁 The latest 96-hour trend is displayed every 1, 5 or 10 minutes;

Pick **TREND GRAPH** in the **SYSTEM MENU** to call up the following menu:

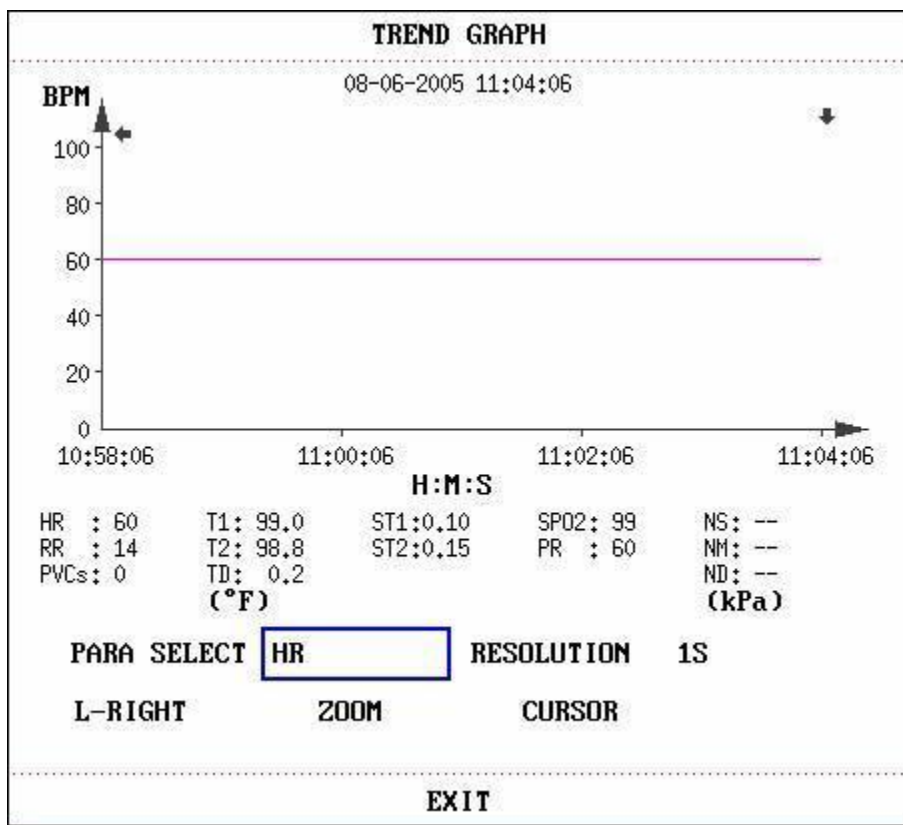

Figure 9-1 Trend Graph Menu

In the trend graph, the y-axis stands for the measured value and x-axis time. "↓" is the cursor of the trend graph, the parameter value of the position pointed by the cursor is displayed below the trend graph and the corresponding time is displayed above the trend graph. Other trends except NIBP trend are displayed as continuous curves. In NIBP trend graph, "▼" indicates systolic value, "▲" indicates diastolic value, and "\*" indicates mean value.

#### To select trend graph of a specific parameter

Pick **PARA SELECT** item and select a requested parameter name by turning the knob.

### To select 1-hour or 96-hour trend graph

Pick **RESOLUTION** item, choose 1 or 5 sec for 1-hour trend graph and 1, 5 or 10 min for 96-hour trend graph.

### To view other trend curves

When " ➤ " appears on the right part of the screen, pick **L-RIGHT**, turn the knob clockwise to view later trend curves. When " ➤ " appears on the left part of the screen, pick the same item, turn the knob counterclockwise to view earlier trend curves.





### To change the display scale

Pick the **ZOOM** button to adjust the y-axis scale and thus change the trend curve in proportion. The value beyond maximum value will be represented by the maximum value.

### To obtain trend data of a specific time

The time to which the cursor points will change as the knob is turned. Parameter at this time is displayed below the x-axis. When " ➤ " appears on the right part of the screen, the trend graph pages down for later trend curves as the cursor moves here. When " ➤ " appears on the left part of the screen, the trend graph pages up for earlier trend curves as the cursor moves here.

### Mark Event

If an event is marked **A, B, C, or D**, then the corresponding event type will display on the time axis of the trend graph, such as , ,  or .

### Operation Example

To view the NIBP trend graph of the last 1 hour:

- ① Pick the **Menu** button on the lower right of the screen.
- ② Pick **TREND GRAPH** item in the **SYSTEM MENU**.
- ③ Select parameter: pick the **PARA** item and turn the knob until NIBP appears.
- ④ Select **1S** or **5S** in the **RESOLUTION** item.
- ⑤ Pick the **L-Right** button and turn the knob to view changes of the trend graph time and trend curve.
- ⑥ Stop at requested trend time section for careful review. Pick the **ZOOM** button to adjust the display scale if necessary.
- ⑦ For measurement result of a specific time, pick **CURSOR** to move the cursor to the point. Then the corresponding time and value will display above and below the waveform respectively.
- ⑧ Pick **EXIT** to return to trend graph display.

## 9.2 Trend Table

- ① The latest 96-trend table data can be displayed every 1, 5, 10, 30, or 60 minutes.

Pick **TREND TABLE** in the **SYSTEM MENU** to call up the following menu:



TREND TABLE			
TIME	EVENT	HR BPM	PUCs /min
(06)11:04		60	0
(06)11:03		60	0
(06)11:02		60	0
(06)11:01		60	0
(06)11:00		60	0
(06)10:59		60	0
(06)10:58		60	0
(06)10:57		60	0
(06)10:56		60	0
(06)10:55		60	0
(06)10:54		60	0
(06)10:53		60	0

RESOLUTION  UP-DOWN L-RIGHT

EXIT

Figure 9-2 Trend Table

Time corresponding to each group of trend data is displayed in the leftmost list with date in brackets. Marked event corresponds to marking time. Trend data of each parameter is divided into 8 groups.

HR, PVC  
 ST1, ST2  
 RR  
 T1, T2, TD  
 SpO<sub>2</sub>, PR  
 NIBP NS/NM/ND  
 IBP1, IBP2  
 CO<sub>2</sub>, INS, AWRR  
 TB

The CO<sub>2</sub> module and GAS module can not be measured at the same time, so their trend graph can not be displayed at the same time.

The **IBP1, IBP CO<sub>2</sub>, INS, AWRR, TB** are optional according to the product models.

### To choose a trend table of a different resolution

Pick the **RESOLUTION** item and turn the knob to change its content so as to change the time interval of trend data.

### To view other trend data

When "▲" appears on the upper part of the screen, pick **UP-DOWN** button and turn the knob counterclockwise to view later trend data. When "▼" appears on the lower part of the screen, pick the same item and turn the knob clockwise to view earlier trend data.

### To obtain trend data of different parameters

Pick **L-RIGHT** to select one from the 8 groups of parameters. "▶" by the rightmost item indicates the next page available. "◀" by the leftmost item indicates the previous page available.

### Mark Event

If an event is marked **A**, **B**, **C**, or **D**, the corresponding event type will display on the Time axis of the trend table.

### Operation Example

To view a NIBP trend table:

- ① Pick the **Menu** button on the lower right of the screen to access **SYSTEM MENU**.
- ② Pick **TREND TABLE**.
- ③ Pick **L-RIGHT** and switch to NIBP by turning the knob.
- ④ Pick **RESOLUTION** to select requested time interval.
- ⑤ Pick **UP-DOWN** and turn the knob to view NIBP trend data of different time.
- ⑥ Pick **EXIT** to return to **SYSTEM MENU**.

## 9.3 NIBP Recall

The monitor can review the latest 500 NIBP measurement data.

Pick **NIBP RECALL** in the **SYSTEM MENU** to invoke the result and time of the latest 15 measurements, as shown in the figure below.

NIBP RECALL					
	NS	NM	ND	PR	TIME
1.	111	86	74	64	2008-11-06 15:49:39
2.	111	89	78	58	2008-11-06 15:49:39
3.	110	84	72	62	2008-11-06 15:49:39
4.	111	87	76	66	2008-11-06 15:49:38
5.	116	90	77	57	2008-11-06 15:49:38
6.	119	92	79	59	2008-11-06 15:49:38
7.	113	87	75	65	2008-11-06 15:49:38
8.	114	88	76	66	2008-11-06 15:49:38
9.	112	87	75	65	2008-11-06 15:49:37
10.	113	89	77	57	2008-11-06 15:49:37
11.	119	87	71	61	2008-11-06 15:49:37
12.	117	90	77	67	2008-11-06 15:49:37
13.	118	88	73	63	2008-11-06 15:45:05

NUM:0      UNIT      mmHg      UP-DOWN      REC

EXIT

Figure 9-3 NIBP Recall

Data is listed chronologically from the latest to the earliest. 15 measurements can be displayed on one screen. Pick **UP-DOWN** to view up to 500 results of measurements. When you press the **RECORD** button, the recorder will print out the metrical data of current window.

**NOTE:**

When the user set the **NIBP SETUP > PR (NIBP)** to **ON**, the PR parameter will display in the menu of **NIBP RECALL**; if set it to **OFF**, the PR parameter area displays .

### 9.4 Alarm Event Recall

The monitor can display the latest 60 alarm events.

Select **ALARM RECALL** in the **SYSTEM MENU** to access **ALARM RECALL CONDITION** menu as shown below.

ALARM RECALL CONDITION					
ALARM RECALL TIME					
START	2006	-	1	-	12 14 : 52
END	<input type="checkbox"/> CURRENT TIME <input checked="" type="checkbox"/> SELF-DEFINE				
	---	-	---	-	---
ALARM RECALL EVENT ALL					
ALARM RECALL >>					
EXIT					

Figure 9-4 ALARM RECALL CONDITION

In this menu, the user may select the conditions for alarm review, including:

1. Start and End time of review:

The user may select the start time of review in the item of **START**.

Then the user may select the end time of review. Two selections are available: current time and the user-defined time.

For user-defined end time, the user can use the knob to select.

2. ALARM RECALL EVENT

In the pull-down list of **ALARM RECALL EVENT**, the user can select the parameter whose alarm events he wants to review. The selections include **ALL** (alarm events of all parameters), ECG, REST, SpO<sub>2</sub>, NIBP, PR(NIBP), IBP, TEMP, CO<sub>2</sub>, CO, HR\_H>180 (the value of HR is above the upper alarm limit), HR\_L<60 (the value of HR is below the lower alarm limit), SpO<sub>2</sub><90%, IBP\_H>200mmHg, IBP\_L<40mmHg, RR\_H>40, RR\_L<10, TEMP\_H>40°C, TEMP\_L<34°C.

After setting up all the review conditions, press the **ALARM RECALL** button to access **ALARM RECALL** window.

## ALARM RECALL

The **ALARM RECALL** window is as shown below, in which the following data are displayed:

- ① Time span (Format: month-day-year hour: minute-month-day-year hour: minute).
- ② Event type.
- ③ Serial number (Format: NO. ×× of ××).
- ④ The value at the time of alarm. NIBP result is with time.
- ⑤ Two 8/16/32-second waveforms.

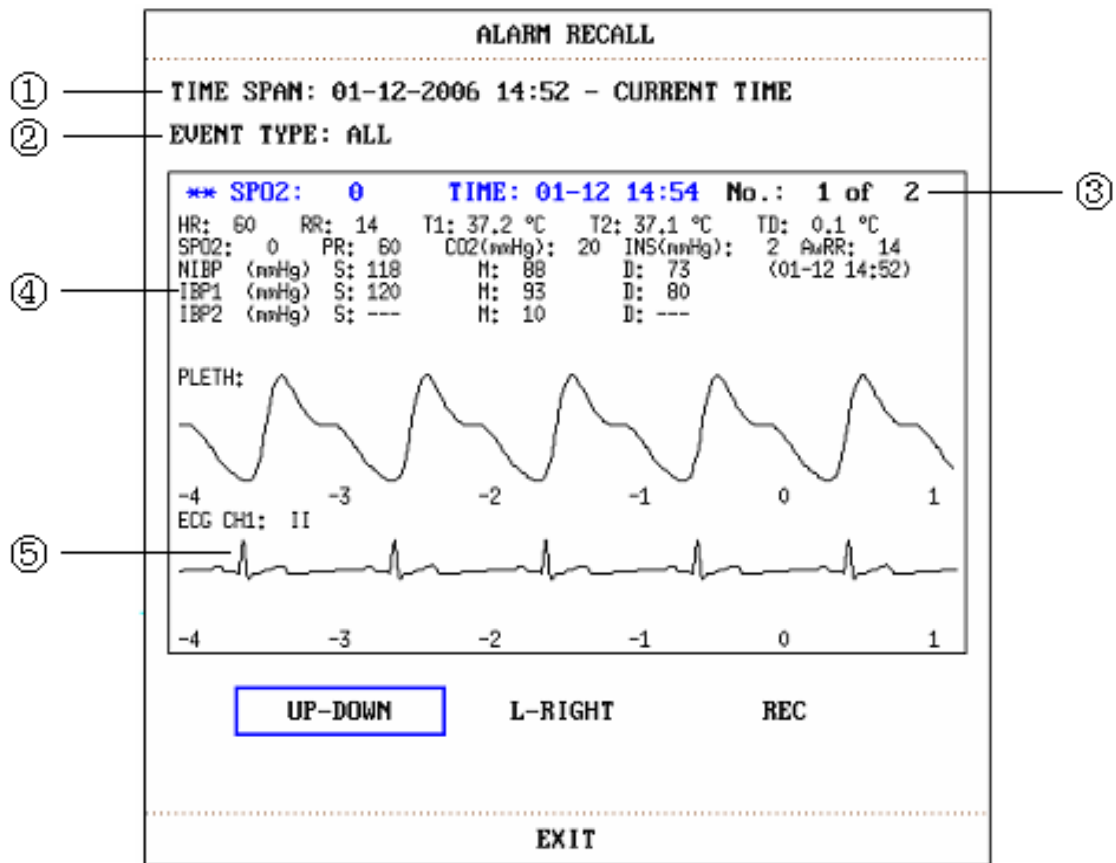

Figure 9-5 ALARM RECALL Menu

**NOTE:**

When the user set the **NIBP SETUP > PR (NIBP)** to **ON**, the **PR** parameter will display in the menu of **ALARM RECALL**; if the user set it to **OFF**, the **PR** parameter will not display.

**To view all waveforms during the alarming process**

Pick **L-RIGHT** and turn the knob to view all 8/16/32-second waveforms stored.

**To view other alarm events**

Events of up to 60 are listed chronologically from the latest to the earliest. Pick **UP-DOWN** button and turn the knob to view later or earlier events.

**Recording**

Pick **REC** to print out all data and waveforms of this event.

## Chapter 10 Drug Calculation and Titration Table (Optional)

The patient monitor provides drug calculation and titration table display functions for fifteen drugs and outputs the content of titration table on the recorder.

### 10.1 Drug Calculation

The drug calculations that can be performed by the system are **AMINOPHYLLINE**, **DOBUTAMINE**, **DOPAMINE**, **EPINEPHRINE**, **HEPARIN**, **ISUPREL**, **LIDOCAINE**, **NIPRIDE**, **NITROGLYCERIN** and **PITOCIN**. **DRUG A**, **DRUG B**, **DRUG C**, **DRUG D** and **DRUG E** are also provided to flexibly replace any of the drugs.

By selecting **DRUG CALC** in **SYSTEM MENU**, the following **DRUG CALC** window appears:

DRUG CALC				
DRUG NAME	AMINOPHYLLINE		INF RATE 60.00	ml/hr
WEIGHT	70.0	kg	DRIP RATE 20.00	GTT/min
AMOUNT	500.00	mg	DROP SIZE 20.00	GTT/ml
VOLUME	500.00	ml	DURATION 8.33	hr
CONCENTRAT	1.00	mg/ml		
DOSE/min	1.00	mg	Please carefully verify	
DOSE/hr	60.00	mg	the input information!	
DOSE/kg/min	14.29	mcg		
DOSE/kg/hr	857.14	mcg	TITRATION >>	
EXIT				

Figure 10-1 DRUG CALC menu

The following formulas are applied to dose calculation:

Concentrate = Amount / Volume

INF Rate = DOSE / Concentrate

Duration = Amount / Dose

Dose = Rate × Concentrate

DRIP Rate = INF Rate / 60 × DROP Size

**Operating Method:**

In the Drug Calculation window, the operator should first select the name of the drug to be calculated, and then confirm the patient weight. Afterwards, the operator should also enter other known values.

Turn the knob to select the value of the item to be calculated. Turn the knob to change the value. When it is the required value, press the knob to view the calculation result. Each item has its calculation range. If the result exceeds the range, it displays “---.--”.

**NOTE:**

- 1 For the drug calculation, the prerequisite is that the operator must first of all enter the patient weight and drug name. The system then gives a group of random initial values, which cannot be used by the operator as the calculation reference. Instead, he should enter a new group of values at the doctor's instruction.
- 2 Each drug has its fixed unit or unit series. Operator must select the proper unit at the doctor's instruction. If the result exceeds the system-defined range, it will display “---”.
- 3 After entering a value, a conspicuous prompt will appear in the menu warning the operator to confirm the correctness of the entered value. The correct value is the guarantee for the reliability and safety of the calculated results.
- 4 For each entered value, the system will always give a dialog box asking for the user's confirmation. You must be careful when answering each box. The calculated result is reliable only after the entered value is confirmed to be correct.

**Select the Drug Name:**

Turn the knob to pick the **DRUG NAME** item in **DRUG CALC** menu. The user may select the drug name in the pull-down list, including **AMINOPHYLLINE, DOBUTAMINE, DOPAMINE, EPINEPHRINE, HEPARIN, ISUPREL, LIDOCAINE, NIPRIDE, NITROGLYCERIN, PITOCIN, Drug A, Drug B, Drug C, Drug D** and **Drug E**. Calculation for only one type can be generated each time.

**NOTE:**

A, B, C, D or E is only code for drugs instead of their real names. The units for these five drugs are fixed. The operator may select the appropriate units according to the convention of using these drugs. The rules for expressing the units are:

- “mg” series units are fixedly used for drug A, B and C: g, mg, mcg.
- “unit” series units are fixedly used for drug D: unit, k unit, m unit.
- “mEq” is fixedly used for drug E.

**Patient Weight:**

After accessing the **DRUG CALC** window, the operator should enter the patient weight into the first or the second item. The entered weight will be used as the independent data only for the calculation of drug concentration.

**NOTE:**

This drug calculation function acts only as a calculator. That means the patient weight in

Drug Calculation menu and it in Patient Information menu is independent from each other. Therefore if the Weight in Drug Calculation changes, it will not change in Patient Information. In this way, we can say, the Drug Calculation menu is independent from other menus in the system. Any change of it will not affect other information about the patient being currently monitored.

## 10.2 Titration Table

### Access Titration Table:

Select **TITRATION** item in **DRUG CALC** menu to enter titration table display.

Titration table display for drug is as following:

TITRATION -- DRUG A					
<b>AMOUNT</b>	<b>400.00</b>	<b>mg</b>	<b>VOLUME</b>	<b>250.00</b>	<b>ml</b>
<b>DOSE/min</b>	<b>2500.00</b>	<b>mcg</b>	<b>INF RATE</b>	<b>93.75</b>	<b>ml/hr</b>
<b>WEIGHT</b>	<b>70.00</b>	<b>kg</b>	<b>DRIP RATE</b>	<b>31.25</b>	<b>GTT/min</b>
DOSE	INF RATE	DOSE	INF RATE	DOSE	INF RATE
0,00	0,00	10,00	0,38	20,00	0,75
1,00	0,04	11,00	0,41	21,00	0,79
2,00	0,08	12,00	0,45	22,00	0,83
3,00	0,11	13,00	0,49	23,00	0,86
4,00	0,15	14,00	0,53	24,00	0,90
5,00	0,19	15,00	0,56	25,00	0,94
6,00	0,23	16,00	0,60	26,00	0,98
7,00	0,26	17,00	0,64	27,00	1,01
8,00	0,30	18,00	0,68	28,00	1,05
9,00	0,34	19,00	0,71	29,00	1,09
<b>BASIC</b>	<b>DOSE</b>	<b>STEP 1</b>	<b>DOSE TYPE</b>	<b>DOSE/min</b>	
	<b>UP-DOWN</b>		<b>REC</b>		
<b>EXIT</b>					

Figure 10-2 TITRATION

#### ④ Method to operate the titration table:

1. In the **TITRATION** table, turn the knob to pick **BASIC** item. Press and turn the knob to select **INF RATE**, **DOSE** or **DRIP RATE**.
2. Then turn the knob to pick **STEP** item. Select step by pressing the knob. 1 ~ 10 are available for selection with the increments of 1.
3. Turn the knob to pick **DOSE TYPE** item. Press and turn the knob to select the unit in the pull-down list.
4. Use **UP-DOWN** item in the table to view the data in previous or next pages.
5. Turn the knob to pick **REC** item. After pressing the knob, the recorder prints out the data displayed in the current titration table.
6. Turn the knob to pick **EXIT** to return to **DRUG CALC** menu.



Total amount, dose, volume, INF rate, drip rate, patient weight and drug name are displayed on the top of the titration table. The meaning of each English identifier is:

**AMOUNT:** drug amount

**VOLUME:** liquid volume

**DOSE/min:** drug dose

**INF RATE:** flow rate

**DRIP RATE:** drip rate

**WEIGHT:** patient weigh



## Chapter 11 Maintenance/Cleaning

### 11.1 System Check

Before using the monitor, do the following:

- ① Check if there is any mechanical damage;
- ② Check if all the outer cables and accessories are in good condition;
- ③ Check all the functions of the monitor to make sure that the monitor is in good condition.

If you find any damage on the monitor, stop using the monitor on patient, and contact the biomedical engineer of the hospital or Customer Service immediately.

The overall check of the monitor, including the safety check, should be performed only by qualified personnel every 6 ~ 12 months, and each time after fix up.

All the checks that need to open the monitor should be performed by qualified customer service technician. The safety and maintenance check can be conducted by persons from this company. You can obtain the material about the customer service contract from the local company's office.

---

---

#### **WARNING**

- 1 If the hospital or agency that is responding to using the monitor does not follow a satisfactory maintenance schedule, the monitor may become invalid, and the human health may be endangered.
  - 2 Replace battery according to the instruction of our servicing engineer.
- 
- 

#### **NOTE:**

To prolong the life of rechargeable battery, it is recommended to charge it at least once every month, and it must be done after the electric energy is run out.

### 11.2 General Cleaning

---

---

#### **WARNING**

Before cleaning the monitor or the sensor, make sure that the equipment is switched off and disconnected from the power line.

---

---

---

---

#### **CAUTION**

Please pay special attention to the following items:

- 1 Most cleaning agents must be diluted before use. Follow the manufacturer's directions carefully to avoid damaging the monitor.
  - 2 Do not use the grinding material, such as steel, wool etc.
  - 3 Do not let the cleaning agent enter into the chassis of the system.
  - 4 Do not leave the cleaning agents at any part of the equipment.
- 
-

The monitor, cables and accessories must be kept dust-free.

Regular cleaning of the monitor shell and the screen is strongly recommended. Use only non-caustic detergents such as soap and warm water (40°C/104°F maximum) to clean the monitor shell. Do not use strong solvents such as acetone or trichloroethylene.

Take extra care when cleaning the screen of the monitor because it is more sensitive to rough cleaning methods than the housing. Do not permit any liquid to enter the monitor case and avoid pouring it on the monitor while cleaning. Do not allow water or cleaning solution to enter the measurement connectors. Wipe around, except connector sockets.

Examples of disinfectants that can be used on the instrument casing are listed below:

- 👁 Tenside;
- 👁 Diluted Ammonia Water < 3%;
- 👁 Diluted Sodium Hypochlorite (Bleaching agent);
- 👁 Diluted Formaldehyde 35% ~ 37%;
- 👁 Hydrogen Peroxide 3%;
- 👁 Alcohol;
- 👁 Isopropanol.

**NOTE:**

- 1 The diluted sodium hypochlorite from 500ppm (1:100 diluted bleaching agent) to 5000ppm (1:10 bleaching agents) is very effective. The concentration of the diluted sodium hypochlorite depends on how many organisms (blood, mucus) on the surface of the chassis to be cleaned.
- 2 The monitor and sensor surface can be cleaned with hospital-grade ethanol and dried in air or with crisp and clean cloth.
- 3 This company has no responsibility for the effectiveness of controlling infectious disease using these chemical agents. Please contact infectious disease experts in your hospital for details.

## 11.3 Sterilization

To avoid extended damage to the equipment, sterilization is only recommended when stipulated as necessary in the Hospital Maintenance Schedule. Sterilization facilities should be cleaned first.

Recommended sterilization material: Ethylate and Acetaldehyde.

Appropriate sterilization materials for ECG lead and blood pressure cuff are introduced in relative chapters respectively.

---

---

### **WARNING**

---

---

Please sterilize and disinfect timely to prevent the cross infection between patients.

---

---

**CAUTION**

- 1 Follow the manufacturer's instruction to dilute the solution, or adopt the lowest effective concentration.
- 2 Do not let liquid enter the monitor.
- 3 No part of this monitor can be subjected to immersion in liquid.
- 4 Do not pour liquid onto the monitor during sterilization.
- 5 Use a moistened cloth to wipe up any agent remaining on the monitor.

## 11.4 Disinfection

**WARNING**

Do not mix disinfecting solutions (such as bleach and ammonia), or it may produce hazardous gases.

To avoid extended damage to the equipment, disinfection is only recommended when stipulated as necessary in the Hospital Maintenance Schedule. Disinfection facilities should be cleaned first. Appropriate disinfection materials for ECG leads, SpO<sub>2</sub> sensor, blood pressure cuff, TEMP probe, IBP sensor are introduced in relative chapters respectively.

Recommended types of disinfecting agents are:

- 👁 Alcohol
- 👁 Aldehyde

**CAUTION**

Do not use EtO gas or formaldehyde to disinfect the monitor.

## 11.5 Replacement of Fuse

Unscrew the fuse cap anticlockwise, replace the fuse (protector tube) and screw down the fuse cap clockwise. Fuse size: 5×20, Rated value: T1.6AL/250V.

**NOTE:**

Switch off the power switch of the patient monitor before examining the fuse.

## 11.6 Cleaning Battery and Battery Compartment Cover

Use only non-caustic detergents such as soap and warm water (40°C/104°F maximum) to clean the battery. Do not use strong solvent to clean battery, and do not dip the battery in liquid.

## Chapter 12 ECG/RESP Monitoring

### 12.1 What Is ECG Monitoring

Monitoring the ECG produces a continuous waveform of the patient's cardiac electric activity to enable an accurate assessment of his current physiological state. Only proper connection of the ECG cables can ensure satisfactory measurement. On the Normal Display, the monitor provides display of 2-channel ECG waveforms.

- 👁 The patient cable consists of 2 parts The cable connects to the monitor The lead set connects to the patient
- 👁 Use a 3-lead, 5-lead or 12-lead set to monitor the ECG. E6 and E8 modules are available. The E6 module is provided with 3-lead and 5-lead functions; while the E8 module can be provided with 3-lead, 5-lead and 12-lead functions.
- 👁 The monitor displays the Heart Rate (HR), ST segment and Arrhythmia analysis. All of the parameters above can be set as alarm parameters.
- 👁 Lead off detecting: detect all the electrodes, indicate the broken off leads.
- 👁 Anti-electrotome function: if the monitor works with high-frequency electrotome, it will not be deadlock or restarting.
- 👁 Every ECG channel has Pacing impulse rejection and Bandpass filter circuit.
- 👁 Defibrillation protection (needs 1K resistance ECG cables in series) and hardware clamp function.
- 👁 A 20-second monitor stabilization period shall be allowed before testing. The active noise suppression is less than  $0.1\mu\text{A}$ , and has Tall T-wave rejection capability.
- 👁 The response time of heart rate meter to change in heart rate is less than 10s.
- 👁 The type of averaging done to compute the minute heart rate is updated at an interval of 1s.
- 👁 In different gains, the alarm for tachycardia is given within 10s.

#### NOTE:

- 1 In the default settings of the monitor, the ECG waveforms are the first two waveforms from top in the Waveform Area.
- 2 The defibrillator cables should be used in the ECG monitoring that can prevent the cables from being burned by high frequency.

### 12.2 Precautions During ECG Monitoring

#### **WARNING**

- 1 Do not come into contact with the patient, table, or the monitor during defibrillation.

---

**WARNING**

---

- 2 Use only the original ECG cable for monitoring.
  - 3 When connecting the cables and electrodes, make sure no conductive part is in contact with the ground. Verify that all ECG electrodes, including neutral electrodes, are securely attached to the patient but not the conductive part or ground.
- 

**NOTE:**

- 1 Interference from a non-grounded instrument near the patient and ESU interference can cause inaccuracy of the waveform.
- 2 IEC/EN60601-1-2 (protection against radiation is 3v/m) specifies that the electrical field density exceeding 1v/m may cause measurement error in various frequencies. It is accordingly suggested that do not use equipment generating electrical radiation near ECG/RESP monitoring devices.
- 3 The simultaneous use of cardiac pacemaker and other patient-connected equipments does not cause safety hazard.
- 4 If the pacemaker signals are beyond the claimed range, the heart rate may be calculated incorrectly.

## 12.3 Monitoring Procedure

### 12.3.1 Preparation

1. Prepare the patient's skin prior to placing the electrodes.
  - 👁 The skin is a poor conductor of electricity, therefore preparation of the patient's skin is important to facilitate good electrode contact to skin.
  - 👁 Shave hair from sites, if necessary.
  - 👁 Wash sites thoroughly with soap and water. (Never use ether or pure alcohol, because this increases skin impedance).
  - 👁 Rub the skin briskly to increase capillary blood flow in the tissues and remove skin scurf and grease.
2. Attach clip or snap to electrodes prior to placement.
3. Put the electrodes on the patient. Before attaching, apply some conductive jelly on the electrodes if the electrodes are not electrolyte self-supplied.
4. Connect the electrode lead to the patient's cable.
5. Make sure the monitor is ready with power supply.

---

**WARNING**

---

- 1 Placed the electrode carefully and ensure a good contact.
  - 2 Check every day whether there is skin irritation resulted from the ECG electrodes. If yes, replace electrodes every 24 hours or change their sites.
  - 3 Check if the lead connection is correct before monitoring. If you unplug the ECG cable from the socket, the screen will display the error message "ECG LEAD OFF" and the audible alarm is activated.
-

**NOTE:**

For protecting environment, the used electrodes must be recycled or disposed of properly.

### 12.3.2 Placing Electrodes for ECG Monitoring

**NOTE:**

The following table gives the corresponding lead names used in Europe and America respectively. (Lead names are represented by R, L, F, N, C, C1-C6 in Europe, whose corresponding lead names in America are RA, LA, LL, RL, V, V1-V6.)

AHA (America Standard)		IEC (Europe Standard)	
Lead Mode	Color	Lead Mode	Color
RA	White	R	Red
LA	Black	L	Yellow
LL	Red	F	Green
RL	Green	N	Black
V	Brown	C	White
V1	Brown/ Red	C1	White/ Red
V2	Brown/ Yellow	C2	White/ Yellow
V3	Brown/ Green	C3	White/ Green
V4	Brown/Blue	C4	White/ Brown
V5	Brown/Orange	C5	White/ Black
V6	Brown/Purple	C6	White/ Purple

#### Electrode placement for 3-lead set

Take the American standard for example, see Figure 12-1:

- 👁 Red (R) electrode - Be placed near the right shoulder, directly below the clavicle.
- 👁 Yellow (L) electrode - Be placed near the left shoulder, directly below the clavicle.
- 👁 Green (F) electrode - Be placed on the left hypogastrium.

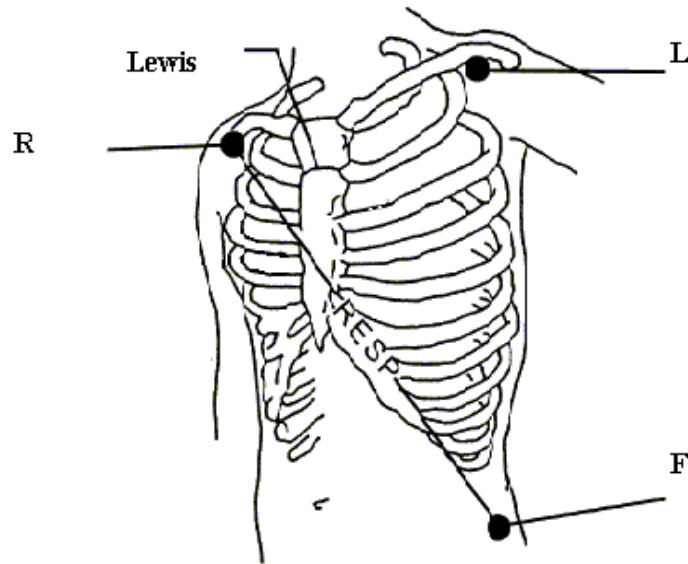

Figure 12-1 Electrode Placement for 3-lead Set

### Electrode placement for 5-lead set

Take the American standard for example, see Figure 12-2:

- 👁 Red (R) electrode - Be placed near the right shoulder, directly below the clavicle.
- 👁 Yellow (L) electrode - Be placed near the left shoulder, directly below the clavicle.
- 👁 Black (N) electrode - Be placed on the right hypogastrium.
- 👁 Green (F) electrode - Be placed on the left hypogastrium.
- 👁 White (C) electrode - Be placed on the chest as illustrated in the Figure 12-3.

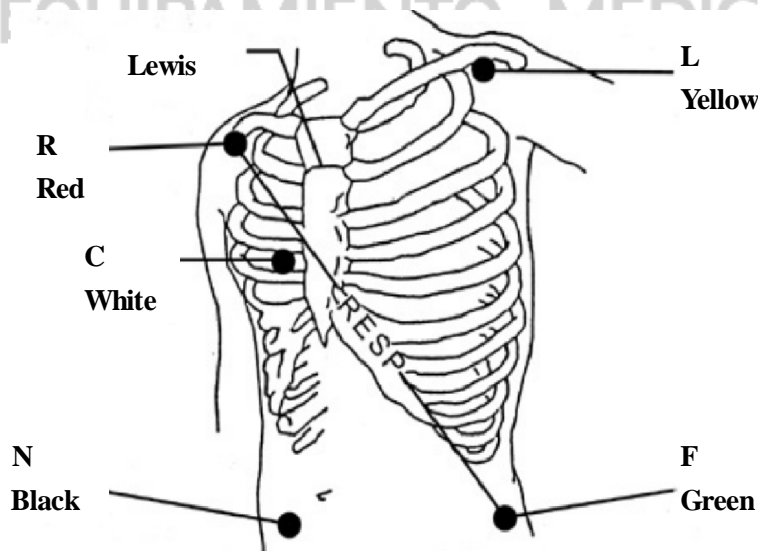

Figure 12-2 Electrode Placement for 5-lead Set

### NOTE:

To ensure patient safety, all leads must be attached to the patient.



For 5-lead set, attach the C (V)-electrode to one of the indicated positions as below (Figure 12-3):

- 👁 V1                    On the 4th intercostal space at the right sterna margin.
- 👁 V2                    On the 4th intercostal space at the left sterna margin.
- 👁 V3                    Midway between V2 and V4 electrodes.
- 👁 V4                    On the 5th intercostal space at the left clavicular line.
- 👁 V5                    On the left anterior axillary line, horizontal with V4 electrode.
- 👁 V6                    On the left middle axillary line, horizontal with V4 electrode.
- 👁 V3R-V7R            On the right side of the chest in positions corresponding to those on the left.
- 👁 VE                    Over the xiphoid position.
- 👁 V7                    On the 5th intercostal space at the left posterior axillary line of back.
- 👁 V7R                   On the 5th intercostal space at the right posterior axillary line of back.

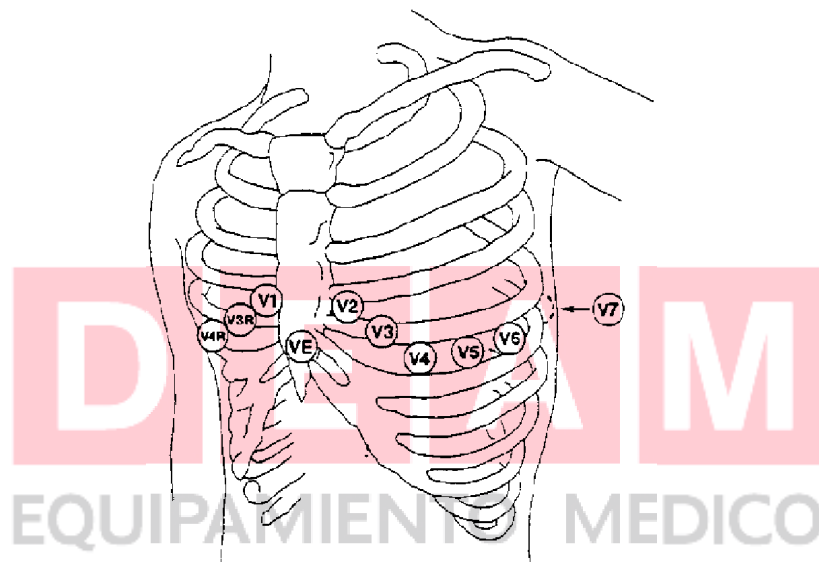

Figure12-3 C-Electrode Placement for 5-lead Set

#### Electrode placement for 12-lead set:

Take the American standard for example, the 12-lead electrodes should be placed on extremities and chest. The electrodes for extremities should be placed on the skin of legs or arms, the electrodes placed on chest should follow the doctor's advice. Please see Figure 12-4.

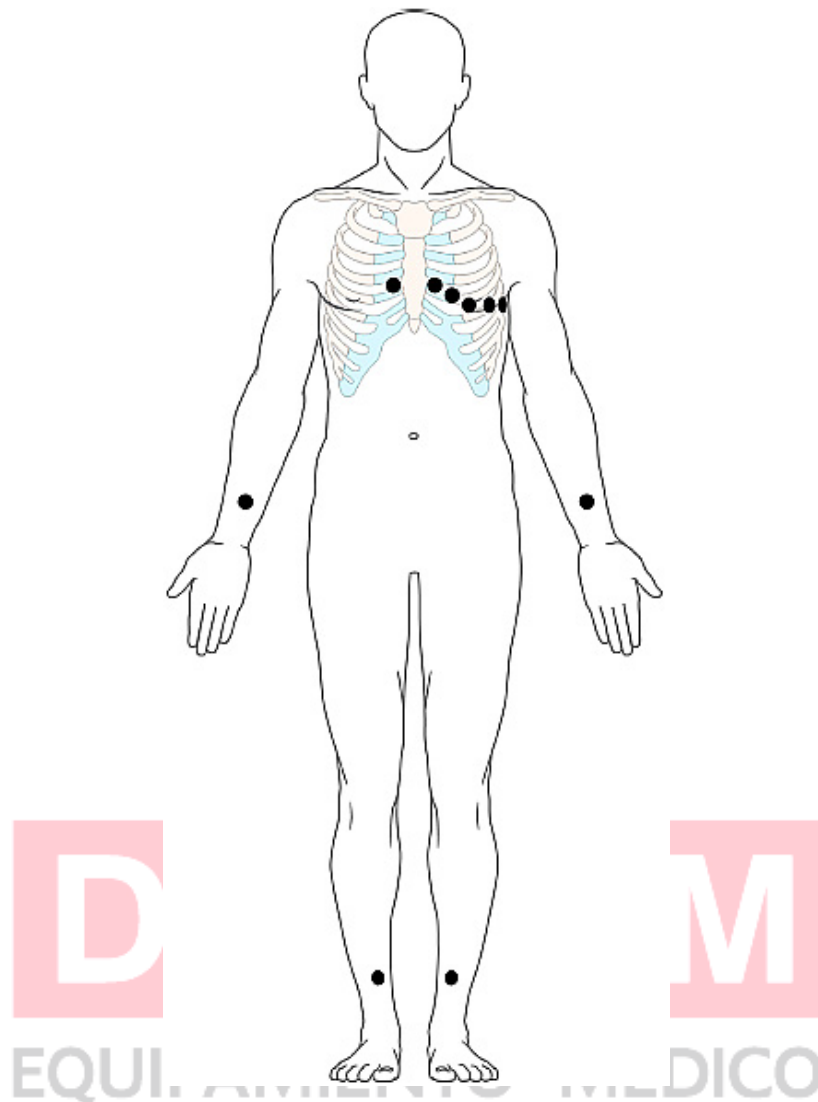

Figure12-4 Electrode Placement for 12-lead Set

## Recommended ECG Lead Placement for Surgical Patients

### **WARNING**

When using Electrosurgery (ES) equipment, leads should be placed in a position in equal distance from Electrosurgery electrotome and the ES grounding plate to avoid cautery. Electrosurgery equipment wire and ECG cable must not be tangled up.

Monitoring ECG leads are mainly used for monitoring the patient's vital signs. When using the patient monitor with other Electrosurgery equipment, it is advised to use the counteracting defibrillation ECG lead.

The placement of the ECG leads will depend on the type of surgery that is being performed. For example, in an open chest surgery the electrodes may be placed laterally on the chest or on the back. In the operating room, artifacts may affect the ECG waveform due to the use of ES (Electrosurgery) equipment. To help reduce this you can place the electrodes on the right and left shoulders, the right and left sides near the abdomen, and the chest lead on the left side at mid-chest. Avoid placing the electrodes on the upper arms. Otherwise the ECG waveform will be too small.

**WARNING**

- 1 When using the monitor with the defibrillator or other high-frequency equipment, please use counteracting defibrillation ECG lead to avoid cautery.
- 2 When using Electrosurgery (ES) equipment, do not place an electrode near the grounding plate of the Electrosurgery device: otherwise there will be a great deal of interference with the ECG signal.

**Using 5-lead ECG Set**

You can set the leads on ECG CH1 and ECG CH2 according to your needs. The lead label is displayed on the upper left part of the waveform. You can set them corresponding to any two from I, II, III, AVR, AVL, AVF and V1~V6. If you set both to the same value, one of them will be adjusted to another option automatically. (Figure 12-5)

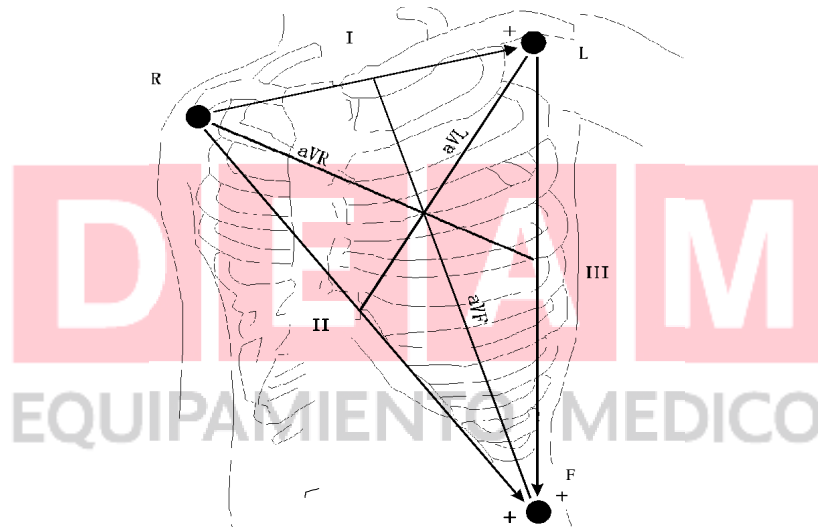

Figure12-5 ECG Lead

**WARNING**

In 5-lead mode, Pace detection  $\pm 2\text{mV} \sim \pm 700\text{mV}$ ; In 3-lead mode, for Pace detection, it is recommended to set as II,  $\pm 2\text{mV} \sim \pm 700\text{mV}$ .

**NOTE:**

- 1 If an ECG waveform is not accurate, while the electrodes are tightly attached, try to change the lead.
- 2 Interference from a non-grounded instrument near the patient and ESU interference can cause inaccuracy of the waveform.

Normal QRS complex should be:

- ① Tall and narrow with no notches.
- ② With tall R-wave completely above or below the baseline.
- ③ With pacemaker spike no higher than R-wave height.
- ④ With T-wave less than one-third of the R-wave height.
- ⑤ With P-wave much smaller than the T-wave.

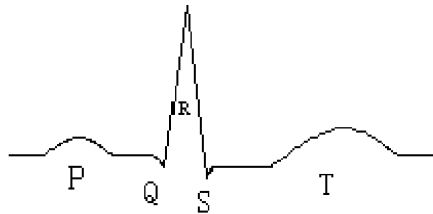

Figure 12-6 Standard ECG Waveform

## 12.4 ECG Screen Hot Keys

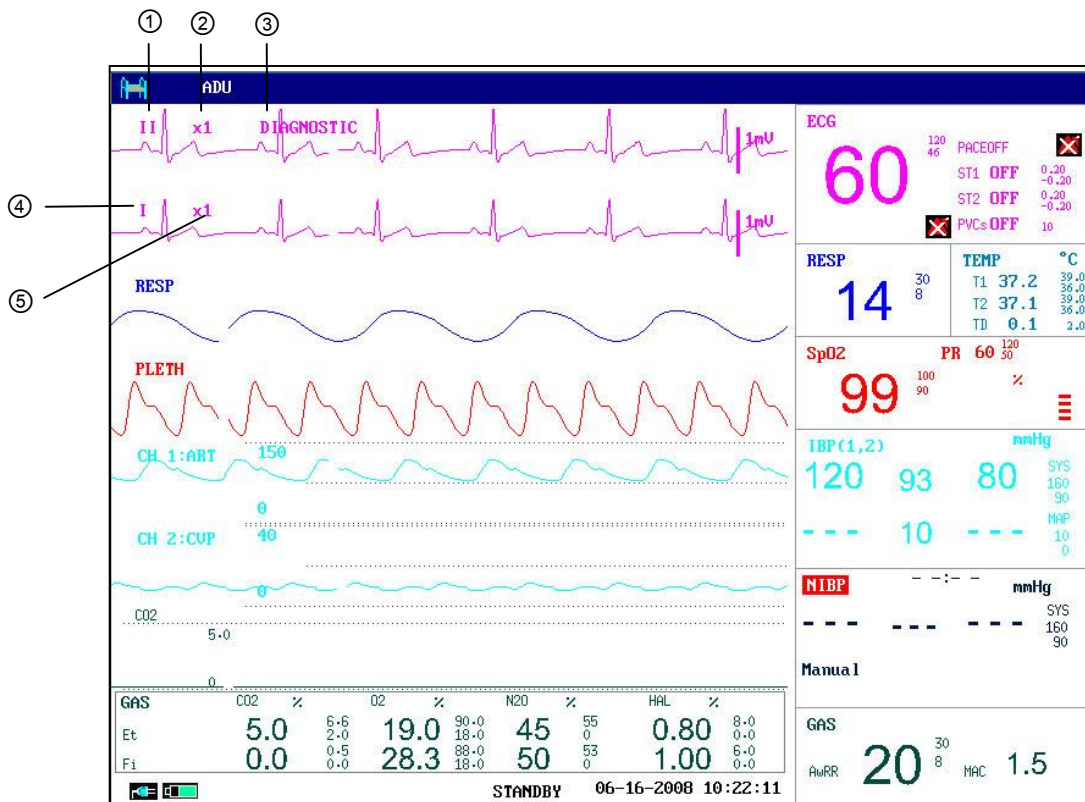

Figure 12-7 Hot Key for ECG

[1]. Leads of channel 1:

I, II, III, AVR, AVL, AVF, V1 ~ V6 are available.

Leads on the ECG wave must not have the same name. Otherwise, the system will automatically change the ECG waveform name that has the same name as the waveform being currently adjusted to another name.

[2]. Waveform gain of channel 1: used to adjust the size of ECG waveforms

Signal amplification and collection of Channel 1 ECG (12 bits, 500Hz), it can collect gain value for each channel setting as  $\times 0.125$ ,  $\times 0.25$ ,  $\times 0.5$ ,  $\times 1$ ,  $\times 2$ ,  $\times 4$  or **AUTO** mode. In **AUTO** mode, the monitor chooses an appropriate level automatically. A 1mV scale displays on each ECG channel's right side. The height of 1mV bar is directly proportional to the waveform amplitude.

**NOTE:**

When the input signals are too strong, the peak of the waveform may not be able to be displayed. In this case the user may manually change the setup method of ECG waveform according to the actual waveform so as to avoid the occurrence of the unfavorable phenomena.

[3]. Filter method: used for displaying clearer and more detailed waveforms

There are three filter modes for selection: **DIAGNOSTIC**, **MONITOR** and **SURGERY** modes. **SURGERY** mode may reduce perturbation and interference from Electrosurgery equipment. The filter method is the item applicable for both channels, which is always displayed at the waveform place of the channel 1 ECG waveform.

**NOTE:**

Only in Diagnosis mode, the system can provide non-processed real signals. In Monitor or Surgery mode, ECG waveforms may be distorted to different extents. In either of the latter two modes, the system can only show the basic ECG and the results of ST analysis may also be greatly affected. In Surgery mode, results of ARR analysis may be somewhat affected. Therefore, it is suggested that in the environment where relatively small interference exists, you'd better monitor a patient in Diagnosis mode.

[4]. Leads of channel 2: refer to [1] for detailed information.

[5]. Waveform gain of channel 2: refer to [2] for detailed information.

**NOTE:**

Pacemaker signal detection is marked by a "P" above the ECG waveform.

## 12.5 ECG Menu

### 12.5.1 ECG SETUP

When the monitor is installed with E6 module, it provides the 3-lead and 5-lead ECG functions. Pick the ECG hot key on the screen, and the following menu will pop up.

ECG SETUP			
HR ALM	ON	HR CHANNEL	CH1
ALM LEV	MED	LEAD TYPE	5 LEADS
ALM REC	OFF	ECG DISPLAY	NORMAL DISPLAY
ALM HI	120	ST ANALYSIS	>>
ALM LO	50	ARR ANALYSIS	>>
HR FROM	ECG	OTHER SETUP	>>
SWEEP	25.0		
EXIT			

Figure 12-8 ECG Setup

### 👁 ECG Alarm Setting

**HR ALM:** pick **ON** to enable prompt message and data record during the ECG alarm; pick **OFF** to disable the alarm function, and there will be a  beside **ECG**.

#### WARNING

In order to avoid endangering the patient's life, the user should use this function cautiously.

**ALM LEV:** selectable from **HIGH, MED, LOW**. Level **HIGH** represents the most serious case.

**ALM REC:** pick **ON** to enable report printing upon ECG alarm.

**ALM HI:** used to set up the upper limit of ECG alarm.

**ALM LO:** used to set up the lower limit of ECG alarm.

ECG alarm is activated when the heart beat exceeds set **ALM HI** value or falls below **ALM LO** value.

The adjusting range of ECG alarm limits is: 15 ~ 350.

Default ECG alarm limits:

	Max.AL M HI	Min. AL M LO	Step
HR ADU	120	50	1
HR PED	160	75	1
HR NEO	200	100	1

The adjusting range of ECG alarm limits:

	<b>Max.ALM HI</b>	<b>Min. ALM LO</b>	<b>Step</b>
<b>HR ADU</b>	300	15	1
<b>HR PED</b>	350	15	1
<b>HR NEO</b>	350	15	1

### **WARNING**

- 1 The response time for heart rate meter to change in heart rate calculation is less than 10s.
- 2 The updating interval of averaging type done to compute the heart rate per minute is 1s.

#### **NOTE:**

Please set the alarm limits according to the clinical conditions of individual patients. The upper limit shall not be 20 beats per min higher than the patient's heart rate.

#### **👁 HR FROM**

**ECG**, **SpO<sub>2</sub>**, **AUTO** and **BOTH** may detect heart rate. **AUTO** distinguishes the heart rate source according to the quality of signal. When the qualities of ECG signal and SpO<sub>2</sub> signal are the same, ECG takes priority over SpO<sub>2</sub>. By picking ECG, the monitor prompts HR and activates HR beep. By picking SpO<sub>2</sub>, the monitor prompts **PULSE** and activates pulse beep.

When SpO<sub>2</sub> is selected, the alarms for HR or PR are available, and the alarm prompt will display in information area, but the alarm limit and alarm flashes are different for them.

**BOTH** mode displays HR and PR simultaneously. When this item is picked, PR parameter is displayed to the right side of SpO<sub>2</sub>. As for the sound of HR or PR in **BOTH** mode, HR is given the priority, i.e., if HR is available, the HR sound will be sent out, but if HR is not available, then the sound will be for PR.

There are 20s for stability before ECG measuring every time.

#### **👁 SWEEP**

Available options for **ECG SWEEP** are 6.25, 12.5, 25.0 and 50.0 mm/s.

#### **👁 HR CHANNEL**

"**CH1**" to count the heart rate by CH 1 waveform

"**CH2**" to count the heart rate by CH 2 waveform

#### **👁 LEAD TYPE**

Users can select either **3 LEADS** or **5 LEADS** for this item.

**👁️ ECG DISPLAY:** it varies according to **LEAD TYPE**.

When **LEAD TYPE** is set to **3 LEADS**, **ECG DISPLAY** can be set to **NORMAL DISPLAY**, it can display one ECG waveform on the main screen.

When **LEAD TYPE** is set to **5 LEADS**, **ECG DISPLAY** can be set to **NORMAL DISPLAY**, **MULTI-LEADS DISPLAY** and **HALF-SCN MULTI-LEADS DISPLAY**. Select **NORMAL DISPLAY** to display two ECG waveforms on the main screen; Select **MULTI-LEADS DISPLAY** to display seven ECG waveforms which occupying the area of seven waveforms on the main screen; Select **HALF-SCN MULTI-LEADS DISPLAY** to display seven ECG waveforms on the screen, occupying the area of four waveforms.

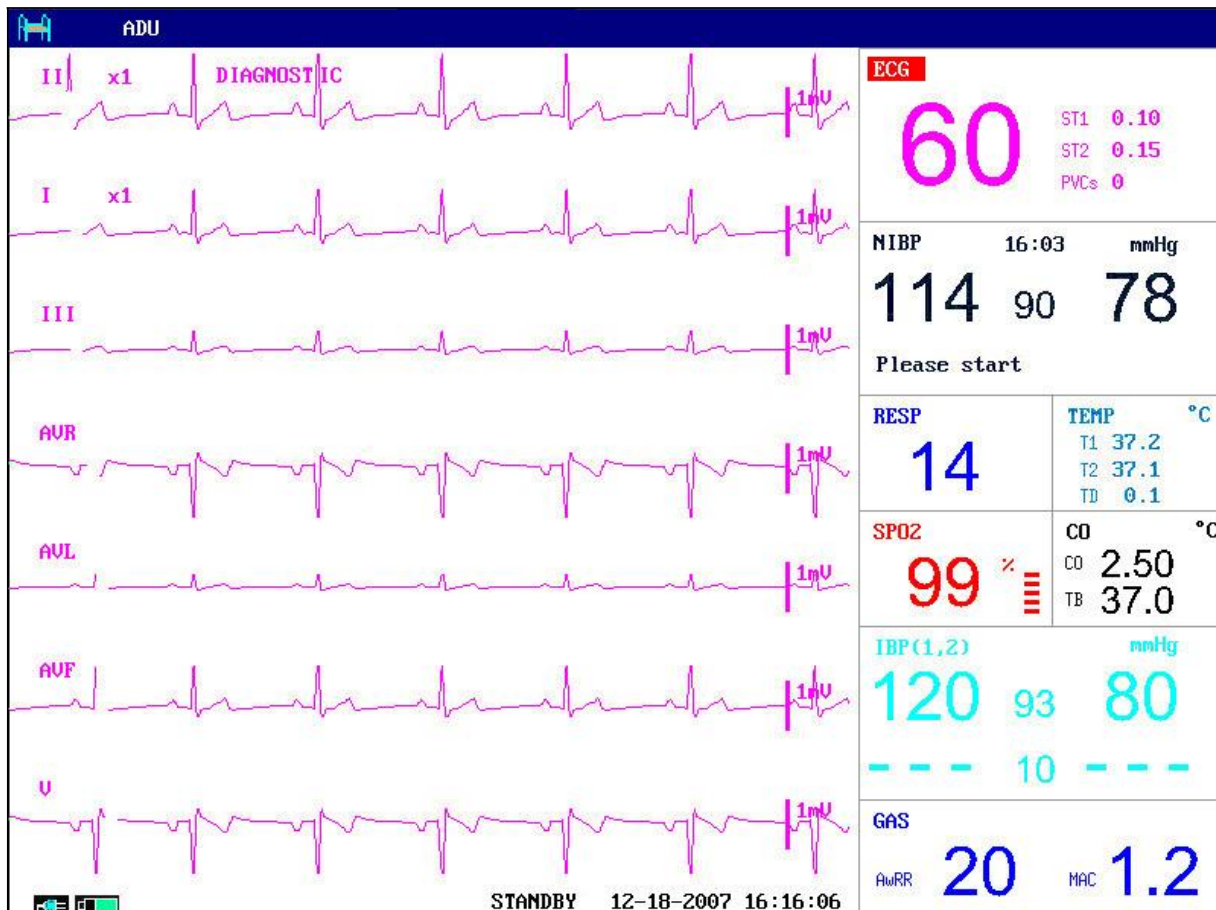

Figure 12-9 MULTI-LEADS display



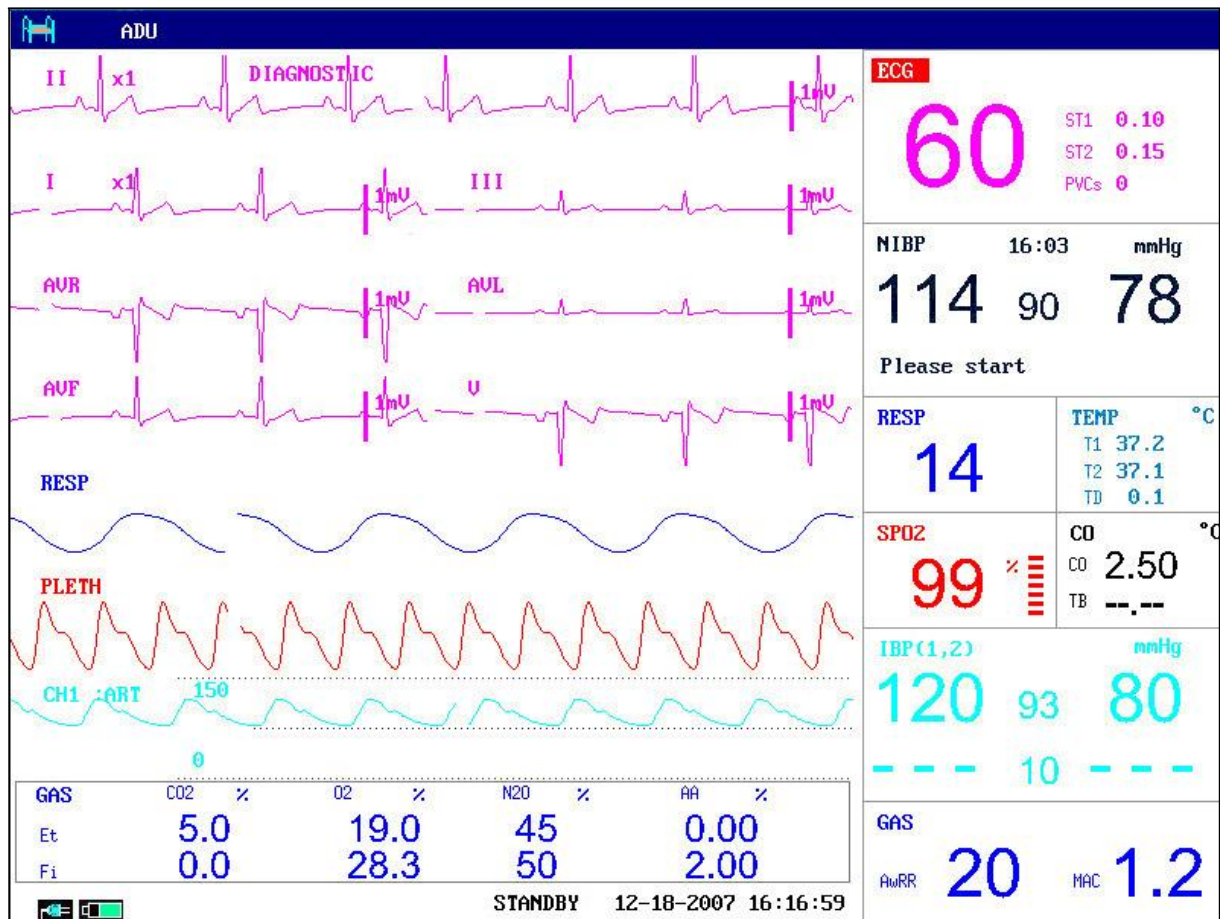

Figure 12-10 HALF-SCN MULTI-LEADS display

**NOTE:**

If **3 LEADS** is selected in the **ECG SETUP** menu, only **NORMAL DISPLAY** can be selected for **ECG DISPLAY** item in the sub-menu.

**ST ANALYSE**

Pick this item to access **ST ANALYSE**. Please refer to *Section 12.7 ST segment monitoring* for details.

**ARR ANALYSE**

Pick this item to access **ARR ANALYSE**. Please refer to *Chapter 12.8 Arr. Monitoring* for details.

**OTHER SETUP**

Pick this item to access **OTHER SETUP** as shown below:

OTHER SETUP		
SMART LEAD OFF ON		
BEAT VOL	2	ECG CAL
PACE	OFF	ADJUST WAVE POS >>
CASCADE	OFF	DEFAULT >>
EXIT		

Figure 12-11 Other Setup menu

Users can access the following functions:

- 👁 **SMART LEAD OFF:** in **5 LEADS** mode, if the **CH1** and **CH2** can not measure because of the lead off or other reasons, it can shift to other **LEADS** to collect a ECG waveform.
- 👁 **BEAT VOL**  
Six selections are available: **0, 1, 2, 3, 4, 5**. “5” indicates maximum volume. “0” indicates no sound.
- 👁 **PACE**  
**ON** detected signal will be marked by a “|” above the ECG waveform  
**OFF** for non-pacemaking patient.

**NOTE:**

When monitoring a patient with a pacemaker, set “**PACE**” to **ON**. If monitoring a patient without a pacemaker, set “**PACE**” to **OFF**.

If “**PACE**” is **ON**, the system will not perform some types of ARR analysis. For detailed information, please refer to the *Section ARR ALARM*.

- 👁 **CASCADE:** turn on or off **CASCADE** display. When it is set to **ON**, the ECG waveform is display in 2 channels. This function is available only for the **NORMAL DISPLAY** in **ECG DISPLAY**.

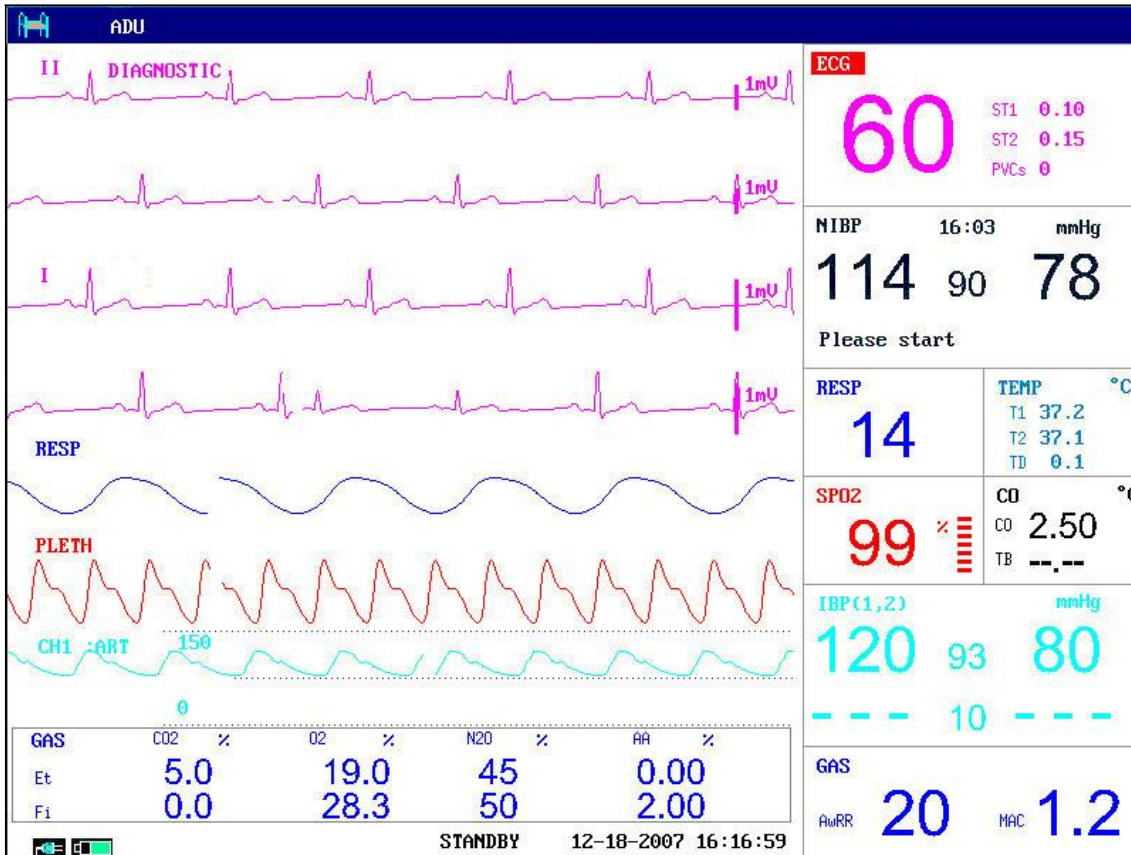

Figure12-12 ECG cascade

**👁 ECG CAL**

Pick this item to start ECG calibrating process. Picking this item again can finish calibrating process.

Users can turn on or off the Power frequency filter of 50Hz or 60Hz in **DIAGNOSTIC** mode. It can use standardized voltage to set the display width for 1mV signal. For example X1 is for 10mm, X2 is for 20mm.

**👁 ADJUST WAVE POS**

Used to adjust the position of ECG waveform on the screen, pick this item to call up the **ADJUST WAVE POS** dialog box. The user may use **CH NAME** item to select the channel to be adjusted, **UP&DOWN** to adjust the position of the selected channel on the screen, **BACK TO DEFAULT** to let the waveform go back to the default position on the screen.

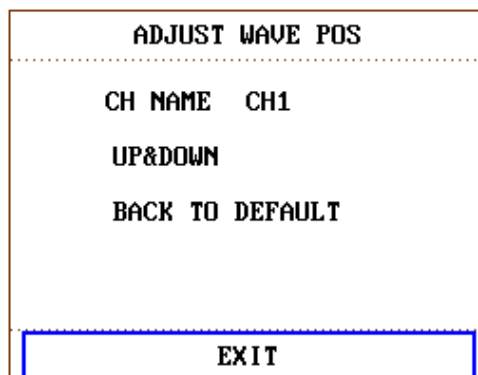

Figure 12-13 ADJUST WAVE POS Menu

**👁️ DEFAULT**

Pick the **DEFAULT** item to call up the **ECG DEFAULT CONFIG** dialog box, in which you can select the **FACTORY DEFAULT CONFIG** or the **USER DEFAULT CONFIG** item. After selecting any of the items and exiting the dialog box, the system will pop up a dialog box asking for your confirmation.

**WARNING**

For patients with pacemakers, the pacing impulse analysis function must be switched **ON**. Otherwise, the pacing impulse may be counted as normal QRS complex, which results in failure of **ECG LOST** error detection.

**NOTE:**

When **PACE** Switch is **ON**, the Arrhythmia events related to **PVCs** will not be monitored. At the same time, the ST analysis will not be performed either.

If the monitor can do ST segment monitoring and Arrhythmia monitoring, please refer to *Section 12.7* and *12.8*.

**12.5.2 12-lead ECG**

When the monitor is installed with E8 module, it provides the 3-lead, 5-lead and 12-lead ECG functions.

Pick the ECG hot key on the screen, and the following menu will pop up.

ECG SETUP			
HR ALM	ON	CAL LEAD	II
ALM LEV	MED	LEAD TYPE	5 LEADS
ALM REC	OFF	ECG DISPLAY	NORMAL DISPLAY
ALM HI	120	12 LEADS ANALYSE	RECALL
ALM LO	50	ST ANALYSE	>>
HR FROM	ECG	ARR ANALYSE	>>
SWEEP	25.0	OTHER SETUP	>>
EXIT			

Figure 12-14 ECG Setup

**👁️ ECG Alarm Setting**

**HR ALM:** pick **ON** to enable prompt message and data record during the ECG alarm; pick **OFF** to disable the alarm function, and there will be a  beside **ECG**.

**WARNING**

In order to avoid endangering the patient's life, the user should use this function cautiously.

**ALM LEV:** selectable from **HIGH, MED, LOW**. Level **HIGH** represents the most serious case.

**ALM REC:** pick **ON** to enable report printing upon ECG alarm.

**ALM HI:** used to set up the upper limit of ECG alarm.

**ALM LO:** used to set up the lower limit of ECG alarm.

ECG alarm is activated when the heart beat exceeds set **ALM HI** value or falls below **ALM LO** value.

The adjusting range of ECG alarm limits is: 15 ~ 350.

Default ECG alarm limits:

	<b>ALM HI</b>	<b>ALM LO</b>	<b>Step</b>
<b>HR ADU</b>	120	50	1
<b>HR PED</b>	160	75	1
<b>HR NEO</b>	200	100	1

The adjusting range of ECG alarm limits:

	<b>Max.AL M HI</b>	<b>Min. AL M LO</b>	<b>Step</b>
<b>HR ADU</b>	300	15	1
<b>HR PED</b>	350	15	1
<b>HR NEO</b>	350	15	1

**NOTE:**

- 1 Please set the alarm limits according to the clinical conditions of individual patients. The upper limit shall not be 20 bpm higher than the patient's heart rate.
- 2 The response time for heart rate meter to change in heart rate calculation is less than 10s. The updating interval of averaging type done to compute the heart rate per minute is 1s.
- 3 Alarm for tachycardia with different gain is given within 10s.

**👁 HR FROM**

**ECG, SpO<sub>2</sub>, AUTO** and **BOTH** may detect heart rate. **AUTO** distinguishes the heart rate source according to the quality of signal. When the qualities of ECG signal and SpO<sub>2</sub> signal are the same, ECG takes priority over SpO<sub>2</sub>. By picking ECG, the monitor prompts HR and activates HR beep.

By picking SpO<sub>2</sub>, the monitor prompts **PULSE** and activates pulse beep.

When SpO<sub>2</sub> is selected, the alarms for HR or PR are available, and the alarm prompt will display in information area, but the alarm limit and alarm flashes are different for them.

**BOTH** mode displays HR and PR simultaneously. When this item is picked, PR parameter is displayed to the right side of SpO<sub>2</sub>. As for the sound of HR or PR in **BOTH** mode, HR is given the priority, i.e., if HR is available, the HR sound will be sent out, but if HR is not available, then the sound will be for PR.

There are 20s for stability before ECG measuring every time.

### 👁️ SWEEP

Available options for **ECG SWEEP** are 6.25, 12.5, 25.0 and 50.0 mm/s.

### 👁️ CAL LEAD

For 3-lead function, this item can be set to **I, II, III** ;

For 5-lead function, this item can be set to **I, II, III, AVR, AVL, AVF, V**;

For 12-lead function, this item can be set to **I, II, III, AVR, AVL, AVF, V1, V2, V3, V4, V5, V6**.

### 👁️ LEAD TYPE

For this item, users can select **3 LEADS, 5 LEADS** or **12 LEADS**.

### 👁️ ECG DISPLAY: it varies according to LEAD TYPE.

When **LEAD TYPE** is set to **3 LEADS**, **ECG DISPLAY** can be set to **NORMAL DISPLAY**, it can display one ECG waveform on the main screen.

When **LEAD TYPE** is set to **5 LEADS**, **ECG DISPLAY** can be set to **NORMAL DISPLAY, MULTI-LEADS DISPLAY** or **HALF-SCN MULTI-LEADS DISPLAY**. Select **NORMAL DISPLAY** to display two ECG waveforms on the main screen; Select **MULTI-LEADS DISPLAY** to display seven ECG waveforms which occupy the area of seven waveforms on main screen; Select **HALF-SCN MULTI-LEADS DISPLAY** to display seven ECG waveforms on the screen, occupying the area of four waveforms.

When **LEAD TYPE** is set to **12 LEADS**, **ECG DISPLAY** can be set to **NORMAL DISPLAY** or **12 LEADS DISPLAY**. Select **NORMAL DISPLAY** to display two ECG waveforms on the main screen; Select **12 LEADS DISPLAY** to display 12-channel ECG waveforms. If you select the **ST ANALYSE**, ST result list will be displayed on the right side. See the following picture:

### NOTE:

In **12 LEADS DISPLAY** mode, the Filter mode only can be set to **DIAGNOSTIC**, and can not be set to **MONITOR** or **SURGERY**.

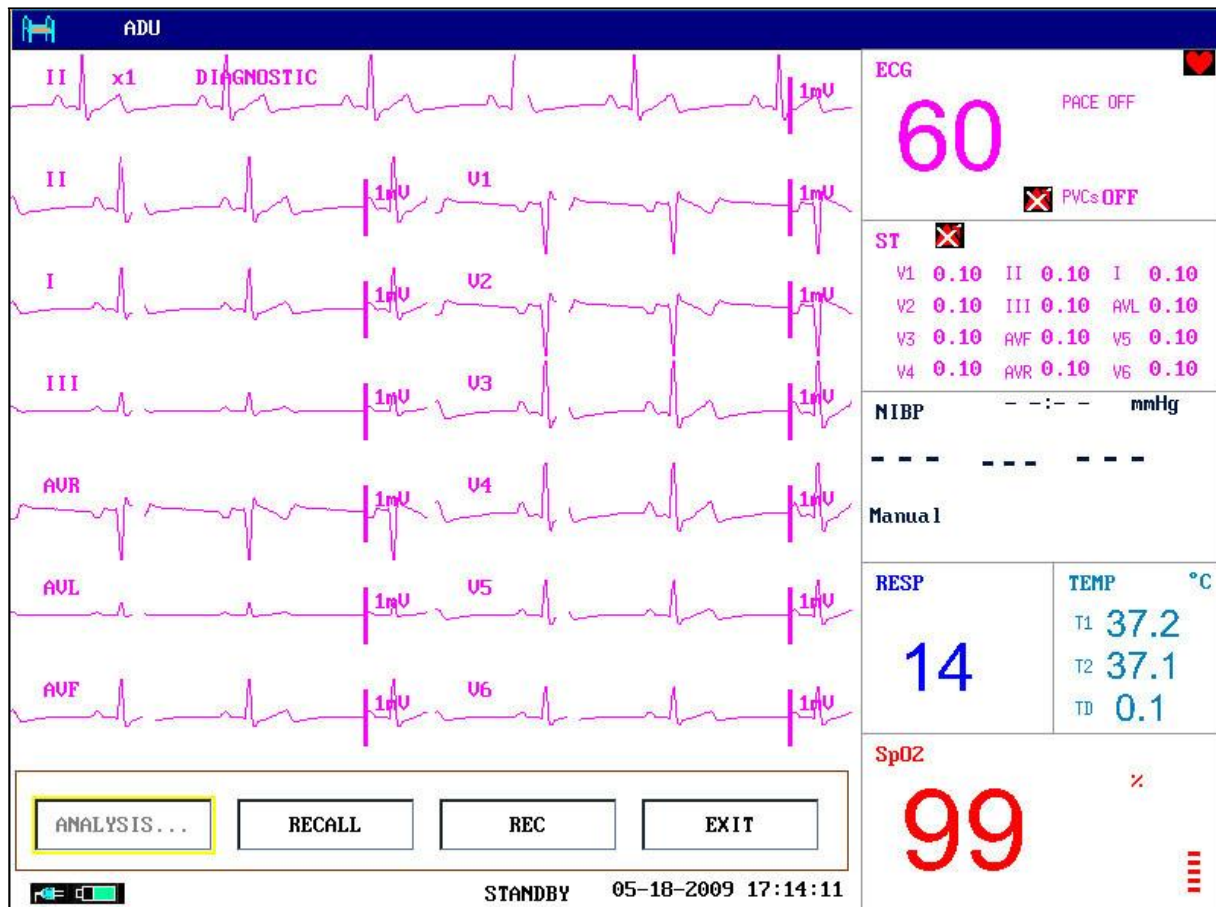

Figure 12-15 12 LEADS DISPLAY mode

- **RECALL:** to recall the 12-lead analysis results, and a maximum of 50 sets of results can be recalled. The analysis results and 10-second waveform can be recorded in the recall menu.
- **REC:** to record the real-time waveform of 12 channels, every wave can be recorded for 10 seconds.
- **EXIT:** to exit the **12 LEADS DISPLAY** mode, return to the normal display screen.
- **ANALYSIS:** set to start the 12-lead analysis, the result will pop up after the analysis is finished, see figure12-16.

**NOTE:**

- 1 During the analysis, if there are other menus displaying on the screen, the results menu will not pop up, but it can also be stored and recalled in the menu.
- 2 If the monitor is not installed with a recorder, it will indicate **NO RECORDER** after pressing the **RECORD** button.

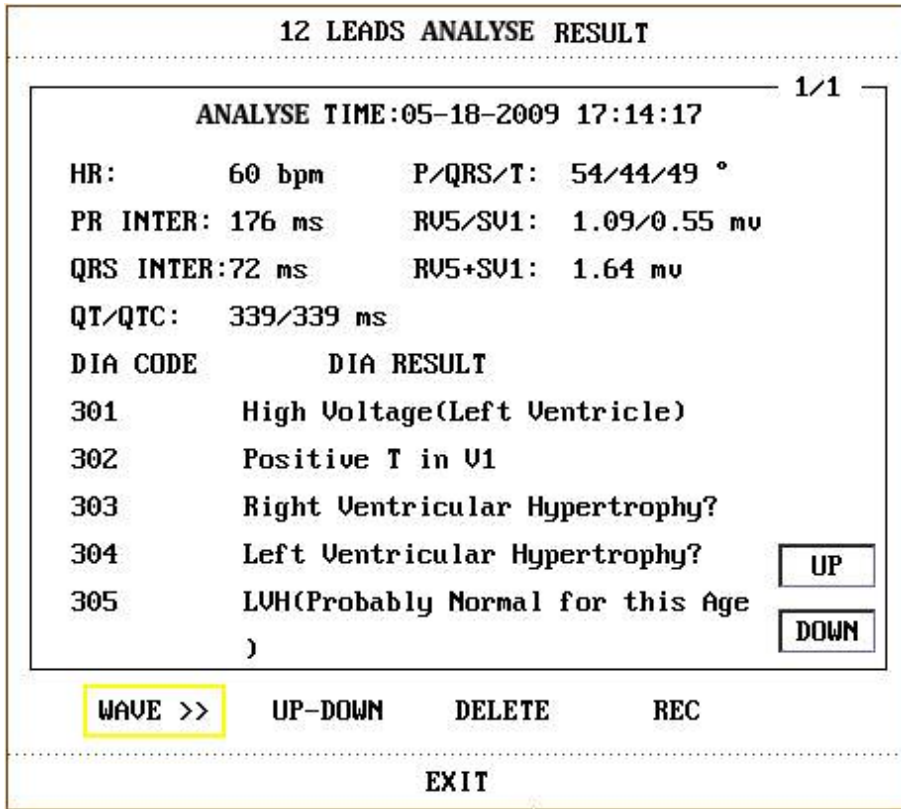

Figure 12-16 12-lead analysis results

Select **UP-DOWN** to see the analysis result on different pages. Then users can select **DELETE** to delete the currently displayed results or select **REC** to record them.

Select **WAVE** to recall the 12-lead waveform, see the following picture:

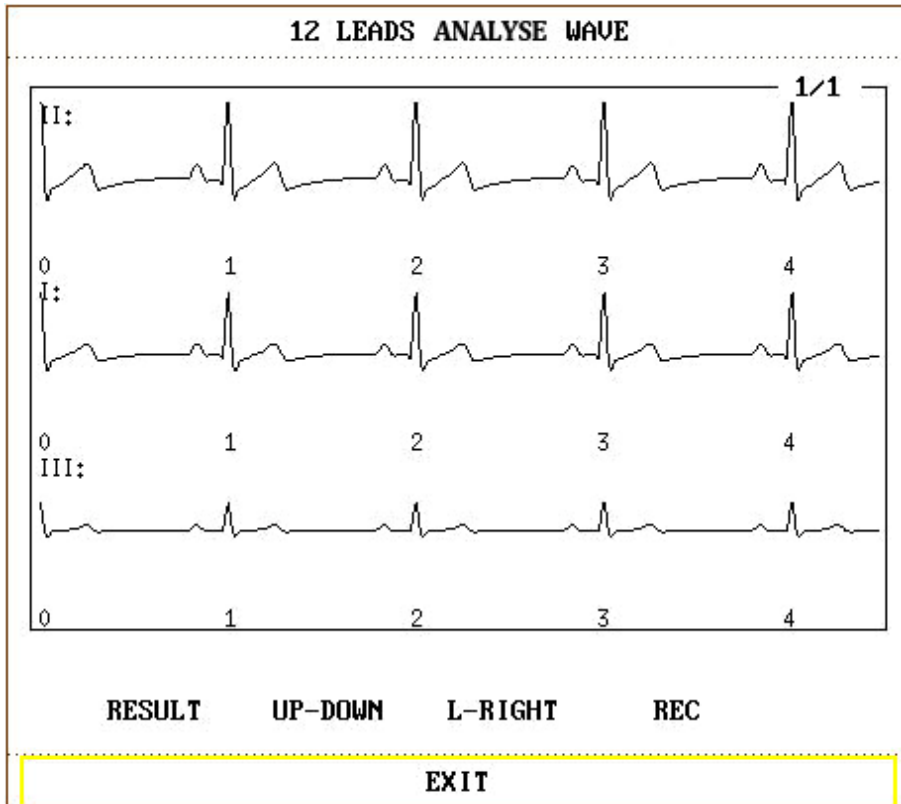

Figure 12-17 12-lead analysis waveforms



Select **UP-DOWN** to see the stored analysis waveform on different pages, select **L-RIGHT** to shift the display of waveform, select **REC** to record the currently stored 12-channel ECG waveforms for 10 seconds, and select **DELETE** to delete the currently displayed results.

Select **RESULT** to return to the result menu of 12 leads.

Select **EXIT** to exit the current menu.

### 👁️ 12 LEADS ANALYSE RECALL

In the 12-lead ECG mode, select this item to display the analysis results. When no result is stored, it prompts: **NO ANALYSE RESULT!**

This menu is the same as the above **12 LEADS ANALYSE RECALL** menu.

**12 LEADS ANALYSE RESULT**

---

1/1

ANALYSE TIME: 05-18-2009 17:14:17

HR:	60 bpm	P/QRS/T:	54/44/49 °
PR INTER:	176 ms	RV5/SV1:	1.09/0.55 mV
QRS INTER:	72 ms	RV5+SV1:	1.64 mV
QT/QTc:	339/339 ms		

DIA CODE	DIA RESULT
301	High Voltage(Left Ventricle)
302	Positive T in V1
303	Right Ventricular Hypertrophy?
304	Left Ventricular Hypertrophy?
305	Lvh(Probably Normal for this Age )

---

---

Figure 12-18 12 LEADS analysis result menu

### 👁️ ST ANALYSE

Pick this item to access **ST ANALYSE** menu. Please refer to *Section 12.7* for details.

### 👁️ ARR ANALYSE

Pick this item to access **ARR ANALYSE** menu. Please refer to *Section 12.8* for details.

### 👁️ OTHER SETUP

Pick this item to access **ECG SETUP** as shown below:

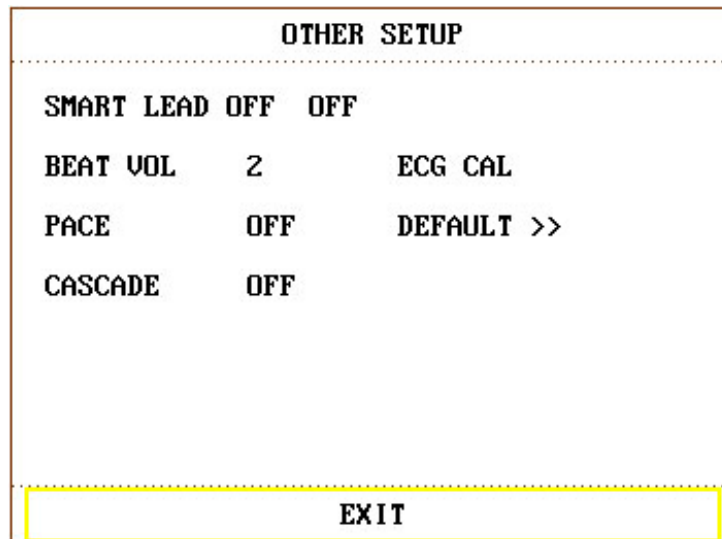

Figure 12-19 Other Setup menu

In the sub-menu, the following functions are available:

- 👁 **SMART LEAD OFF:** in **5 LEADS**, **12 LEADS** mode, if the **CH1** and **CH2** can not measure because of the lead off or other reasons, it can shift to other **LEADS** to collect a ECG waveform.
- 👁 **BEAT VOL**  
Users can set this item to **0, 1, 2, 3, 4** or **5**. **5** indicates maximum volume. **0** indicates no sound.
- 👁 **PACE**  
Set it to **ON**, the detected signal will be marked by a "|" above the ECG waveform.  
Set it to **OFF** for non-pacemaking patient.

**NOTE:**

- 1 When monitoring a patient with a pacemaker, set **PACE** to **ON**. If monitoring a patient without a pacemaker, set **PACE** to **OFF**.
- 2 If **PACE** is **ON**, the system will not perform some types of ARR analysis. For detailed information, please refer to the *Section ARR ALARM*.

- 👁 **CASCADE:** turn on or off **CASCADE** display. When it is set to **ON**, the ECG waveform is display in 2 channels. This function is available only for the **NORMAL DISPLAY** in **ECG DISPLAY**.

👁 **ECG CAL**

Pick this item to start ECG calibrating process. Picking this item again can finish calibrating process.

Users can turn on or off the Power frequency filter of 50Hz or 60Hz in **DIAGNOSTIC** mode. It can use standardized voltage to set the display width for 1mV signal. For example X1 is for 10mm, X2 is for 20mm.

👁 **DEFAULT**

Pick the **DEFAULT** item to call up the **ECG DEFAULT CONFIG** dialog box, in which

you can select the **FACTORY DEFAULT CONFIG** or the **USER DEFAULT CONFIG** item. After selecting any of the items and exiting the dialog box, the system will pop up a dialog box asking for your confirmation.

### **WARNING**

For patients with pacemakers, the pacing impulse analysis function must be switched **ON**. Otherwise, the pacing impulse may be counted as normal QRS complex, which results in failure of **ECG LOST** error detection.

### **NOTE:**

When **PACE** Switch is **ON**, the Arrhythmia events related to **PVCs** will not be monitored. At the same time, the ST analysis will not be performed either.

If the monitor can do ST segment monitoring and Arrhythmia monitoring, please refer to *Section 12.7* and *12.8*.

## **12.6 ECG Alarm Information**

Alarms occurring in the process of ECG measurement contain two types: physiological alarm and technical alarm. For the audio and visual features during the appearance of these alarms in the process of ECG measurement, please refer to the related description in *Chapter6 Alarm*. On the screen, physiological alarm messages are displayed in the Physiological Alarm area. Technical alarms messages are displayed in the Technical Alarm area. This section does not describe the content about Arr. and ST analysis.

Tables below describe respectively the possible various alarms that may occur during the measurement.

Physiological alarms:

<b>Message</b>	<b>Cause</b>	<b>Alarm level</b>
ECG SIGNAL WEAK	Can not detect the signal in designated time period.	High
HR HIGH	HR measuring value is above the upper alarm limit.	User-selectable
HR LOW	HR measuring value is below the lower alarm limit.	User-selectable

Technical alarms: (take American Standard for example):

Message	Cause	Alarm level	What to do
ECG LEAD OFF	More than one ECG electrodes fall off the skin or ECG cables fall off the monitor.	Low	Make sure that all electrodes, leads and patient cables are properly connected.
ECG C LEAD OFF	ECG electrode C falls off the skin or ECG cables fall off the monitor.	Low	
ECG V LEAD OFF	ECG electrode V falls off the skin or ECG cables fall off.	Low	
ECG F LEAD OFF	ECG electrode F falls off the skin or ECG cables fall off the monitor.	Low	Make sure that all electrodes, leads and patient cables are properly connected.
ECG L LEAD OFF	ECG electrode L falls off the skin or ECG cables fall off the monitor.	Low	
ECG R LEAD OFF	ECG electrode R falls off the skin or ECG cables fall off the monitor.	Low Low	Make sure that all electrodes, leads and patient cables are properly connected.
ECG LL LEAD OFF	ECG electrode LL falls off the skin or ECG cables fall off the monitor.	Low	
ECG LA LEAD OFF	ECG electrode LA falls off the skin or ECG cables fall off the monitor.	Low	Make sure that all electrodes, leads and patient cables are properly connected.
ECG RA LEAD OFF	ECG electrode RA falls off the skin or ECG cables fall off the monitor.	Low	
ECG EXCEED	ECG measuring value is beyond measuring range.	High	Check lead connection and patient condition

ECG INIT ERR	ECG module failure	High	Stop using measuring function of ECG module, please notify biomedical engineer or manufacturer's service staff.
ECG COMM STOP	ECG module failure or communication failure	High	Stop using measuring function of ECG module, notify biomedical engineer or manufacturer's service staff.
ECG NOISE	ECG measuring signal is greatly interrupted.	Low	Check lead connection and patient condition
NO RECORDER	The user presses the <b>RECORD</b> button when the monitor is not installed with a recorder.	Low	Notify the manufacturer's service staff to install and set up the recorder.

The monitor with 12-lead ECG has the following alarms:

Message	Cause	Alarm level	What to do
ECG V1 LEAD OFF	ECG electrode V1 falls off the skin or ECG cables fall off.	Low	Make sure that all electrodes, leads and patient cables are properly connected.
ECG V2 LEAD OFF	ECG electrode V2 falls off the skin or ECG cables fall off.	Low	
ECG V3 LEAD OFF	ECG electrode V3 falls off the skin or ECG cables fall off.	Low	
ECG V4 LEAD OFF	ECG electrode V4 falls off the skin or ECG cables fall off.	Low	
ECG V5 LEAD OFF	ECG electrode V5 falls off the skin or ECG cables fall off.	Low	

ECG V6 LEAD OFF	ECG electrode V6 falls off the skin or ECG cables fall off.	Low	
--------------------	---	-----	--

## 12.7 ST Segment Monitoring (Optional)

ST segment monitoring function is shut off by default. You can switch it to **ON** when necessary. When using the ST analysis function, the ST analysis results will be displayed on the right of the main screen, please refer to Figure12-15.

**NOTE:**

- 1 **ST ANALYSE** only can be used only in **ADU** mode.
- 2 When setting **ST ANALYSE** on, the monitor should in **DIAGNOSTIC** mode.
- 3 ECG/RESP monitoring should select **DIAGNOSTIC** mode.

It is available to measure the variance of ST segment with ST analysis at the waveform tracks for selected lead. The corresponding ST measurement result displays numerically at ST1 and ST2 in the Parameter Area. The trend can be viewed in table or graphic form.

- Measurement unit of ST segment: mV.
- Measurement symbol of ST segment: "+" = elevating, "-" = depressing.
- Measurement range of ST segment: -2.0 mV ~ + 2.0 mV.

Pick the **ST ANALYSE** item in the **ECG SETUP** menu to access the **ST ANALYSE** sub-menu as shown below.

### ST ANALYSE Menu

ST ANALYSE	
ST ANALYSE	OFF ALM LIMIT SETUP >>
ST ALM	OFF DEF POINT >>
ALM LEV	MED
ALM REC	OFF
EXIT	

Figure 12-20 ST Analyse menu

### ST Analysis Alarm Setting

**ST ANALYSE:** the switch for ST analysis. Set it to **ON** to activate the ST analysis or **OFF**

to disable the ST analysis.

- ① **ST ALM**: pick **ON** to enable prompt message and data record during the ST analysis alarm; pick **OFF** to disable the alarm function, and there will be a  beside ST. ST alarm is activated when the result exceeds set **ST HI** value or falls below **ST LO** value.

### WARNING

In order to avoid endangering the patient's life, the user should use this function cautiously.

- ① **ALM LEV**: used to set up the ST alarm level. There are three selections: **HIGH**, **MED** and **LOW**.
- ① **ALM REC**: pick **ON** to enable report printing upon ST analysis alarm.
- ① **ALM LIMIT SETUP**: used to set up the upper limit and lower limit of ST alarm. The **ALM HI** can be set to 0.2 mV ~ 2.0 mV, and the **ALM LO** can be set to -2.0 mV ~ 0.2 mV. the setup **ALM HI** should be higher than the **ALM LO**.

Default ST analysis alarm limits:

	<b>ST HI</b>	<b>ST LO</b>	<b>Step</b>
ST	0.2 mV	-0.2 mV	0.1 mV

The adjusting range of ST analysis alarm limits:

	<b>Max. ST HI</b>	<b>Min. ST LO</b>	<b>Step</b>
ST	2.0 mV	-2.0 mV	0.1 mV

- ① **DEF POINT**: pick this item to access the **DEF POINT** window, in which the position of ISO and ST point can be set up.
  - ⑤ **ISO**      Base point. Default is 80 ms.
  - ⑤ **ST**        Measurement point. Default is 108 ms.

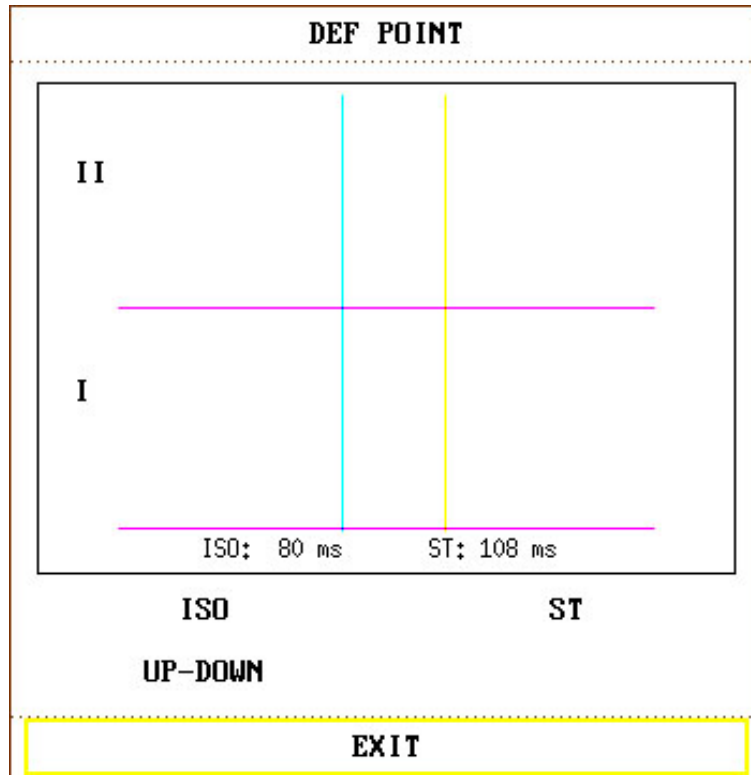

Figure 12-21 DEF POINT Window

The operator can adjust the position of both ISO and ST measurement points. Set the reference point of ST measurement point to be peak point of R-wave.

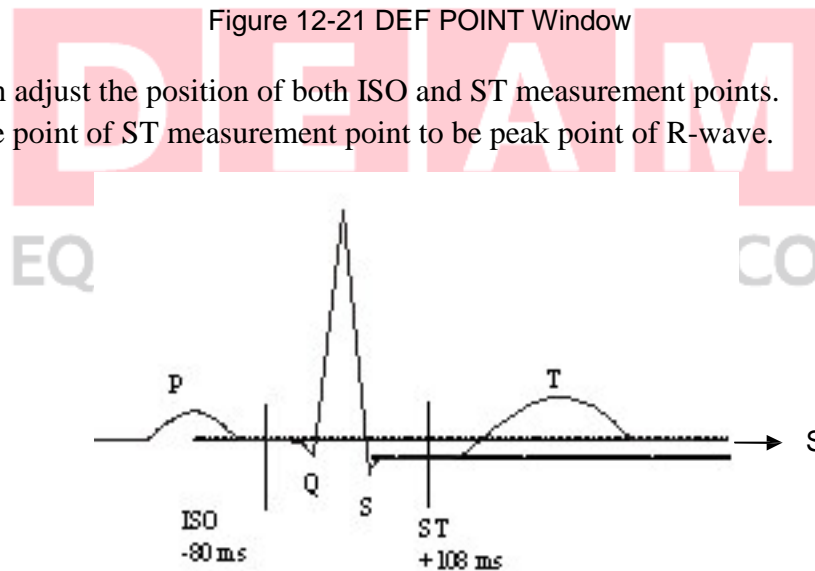

Figure 12-22 DEF POINT

The ST measurement for each beat complex is the vertical difference between the two measurement points.

**NOTE:**

The ST measurement point should be adjusted if the patient's HR or ECG morphology changes significantly.

⑤ Adjusting ISO, ST

These two points can be adjusted by turning the knob.



When adjusting ST measurement point, the system will show the ST Measurement Point Window. The system displays the QRS complex template in the window. It is adjustable for the highlight bar in the window. You may select ISO or ST, switch the knob left or right to move the cursor line. When the cursor is at the required position, you may select the base point or the measurement point.

**NOTE:**

Abnormal QRS complex is not considered in ST segment analysis.

**ST Alarm Message****NOTE:**

The alarm limits for two ST measurements are identical. No setting of alarm limits can be made only for one channel.

Tables below describe the possible physiological alarms.

Physiological alarms:

Message	Cause	Alarm Level
ST1 HIGH	ST measuring value of channel 1 is above the upper alarm limit.	User-selectable
ST1 LOW	ST measuring value of channel 1 is below the lower alarm limit.	User-selectable
ST2 HIGH	ST measuring value of channel 2 is above the upper alarm limit.	User-selectable
ST2 LOW	ST measuring value of channel 2 is below the lower alarm limit.	User-selectable

When using the E8 module, if the ST values are too high or too low, the monitor will give alarms for these parameters of ST value.

Lead Type	Parameters of ST Vaules
3-lead	ST-I , ST-II , ST-III
5-lead	ST-I , ST-II , ST-III, ST-AVR, ST-AVL, ST-AVF, ST-V
12-lead	ST-I , ST-II , ST-III, ST-AVR, ST-AVL, ST-AVF, ST-V1, ST-V2, ST-V3, ST-V4, ST-V5, ST-V6

## 12.8 Arr. Monitoring (Optional)

### Arrhythmia Analysis

The arrhythmia algorithm is used to monitor ECG of neonate and adult patients in clinical, detect the change of heart rate and ventricular rhythm, and also save arrhythmia events and generate alarming information. Arrhythmia algorithm can monitor paced and non-paced patients. Qualified personnel can use arrhythmia analysis to evaluate patient's condition (such as heart rate, PVCs frequency, rhythm and ectopic beat) and decide the treatment. Besides detecting change of ECG, arrhythmia algorithm can also monitor patients and give proper alarm for arrhythmia.

- 👁️ The arrhythmia monitoring is shut off by default. You can enable it when necessary.
- 👁️ This function can call up the doctor's attention to the patient's heart rate by measuring and classifying the arrhythmia and abnormal heart beat and triggering the alarm.
- 👁️ The monitor can conduct up to 16 different arrhythmia analyses.  
Pick the item **ARR ANALYSE** in **ECG SETUP** menu to access the **ARR ANALYSE** sub-menu.
- 👁️ The monitor has a Pacing impulse detection circuit (select one from I, II, III, AVR, AVL, AVF and V).

Every ECG channel has a Pacing impulse rejection and a Band pass filter circuit. Pacing rate >320mV/s (RTT).

**WARNING**

This device is not intended for treatment.

**NOTE:**  
ECG/RESP monitoring should select **DIAGNOSTIC** mode.

### ARR ANALYSE Menu

ARR ANALYSE			
ARR ANALYSE	OFF	ALM HI	10
PVCs ALM	ON	ARR RELEARN	
ALM LEU	MED	ARR ALARM >>	
ALM REC	OFF	ARR RECALL >>	
EXIT			

Figure 12-23 ARR ANALYSE

- 👁️ **ARR ANALYSE:** Pick **ON** during monitoring. It is set to **OFF** by default.

- 👁️ **PVCs ALM:** Pick **ON** to enable prompt message when alarm occurs; pick **OFF** to disable the alarm function, and there will be a  beside **PVCs**.

### WARNING

In order to avoid endangering the patient's life, the user should use this function cautiously.

- 👁️ **ALM LEV:** Selectable from **HIGH, MED, LOW**. Level **HIGH** represents the most serious case.
- 👁️ **ALM REC:** pick **ON** to enable report printing upon PVCs alarm.
- 👁️ **PVCs alarm** is activated when the PVCs exceeds the set **PVCs ALM HI** value.

PVCs alarm upper limits:

	<b>Max.</b>	<b>Min.</b>	<b>Step</b>
PVCs	10	1	1

#### **PVCs Alarm and Prompt Message:**

Tables below describe the possible physiological alarms occurring during PVCs measurement. Physiological alarms:

<b>Message</b>	<b>Cause</b>	<b>Alarm Level</b>
PVCs HIGH	PVCs measuring value is above the upper alarm limit.	User-selectable

- 👁️ **ARR RELEARN** Pick this item to start a learning procedure.
- 👁️ **ARR ALARM** Pick this item to access the **ARR ALARM** dialog box to set arrhythmia alarm parameters.

You can pick **ALL ALM ON** to enable the alarm function of all arrhythmia types and pick **ALL ALM OFF** to disable this function. Likewise, you can pick **ALL REC ON** to enable the recording function of all arrhythmia types and pick **ALL REC OFF** to disable this function. Changing the **ALM LEV** can reset the alarm level of all arrhythmia types to the same value.

- 👁️ **ARR RECALL** Pick this item to review and edit the ARR analysis result.

The latest arrhythmia events (up to 60) are displayed.

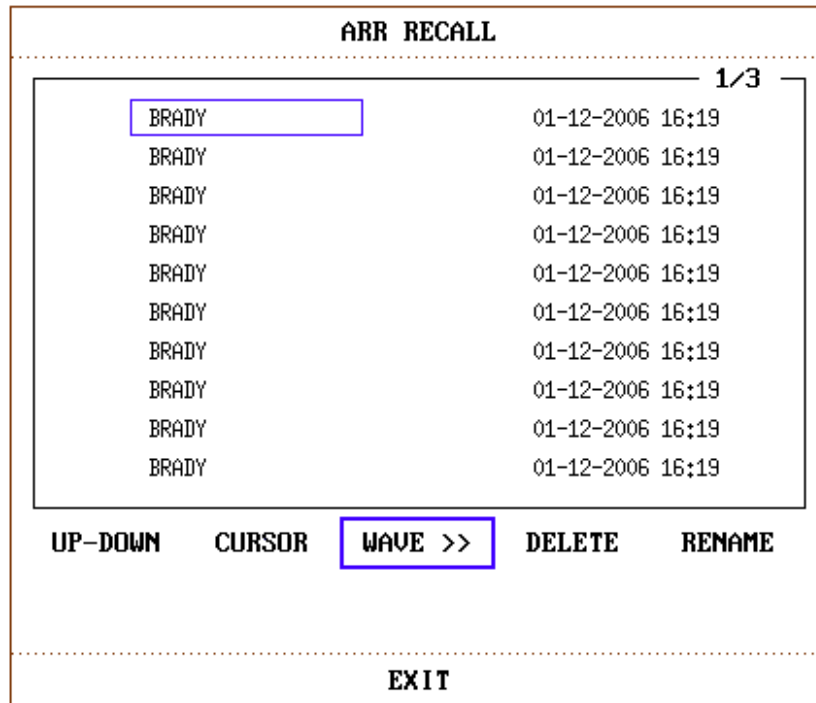

Figure 12-24 ARR RECALL

- ⑤ **UP-DOWN** Observe the event lists on other pages.
- ⑤ **CURSOR** Select the Arr. event, whose name is displayed in a protruding frame.
- ⑤ **DELETE** Delete the selected Arr. event.
- ⑤ **RENAME** Rename the selected Arr. Event displayed in a sunken frame.  
Switch the knob until the name you want appears.
- ⑤ **WAVE** Display the Arrhythmia waveform, time and parameter value.
  - ⑥ **UP-DOWN** To observe the waveforms of other Arrhythmia events.
  - ⑥ **L\_RIGHT** To observe the 8-second waveform of the Arrhythmia events.
  - ⑥ **REC** To print out the displayed Arrhythmia event.
  - ⑥ **EXIT** To return to **ARR RECALL** menu of Arrhythmia event.

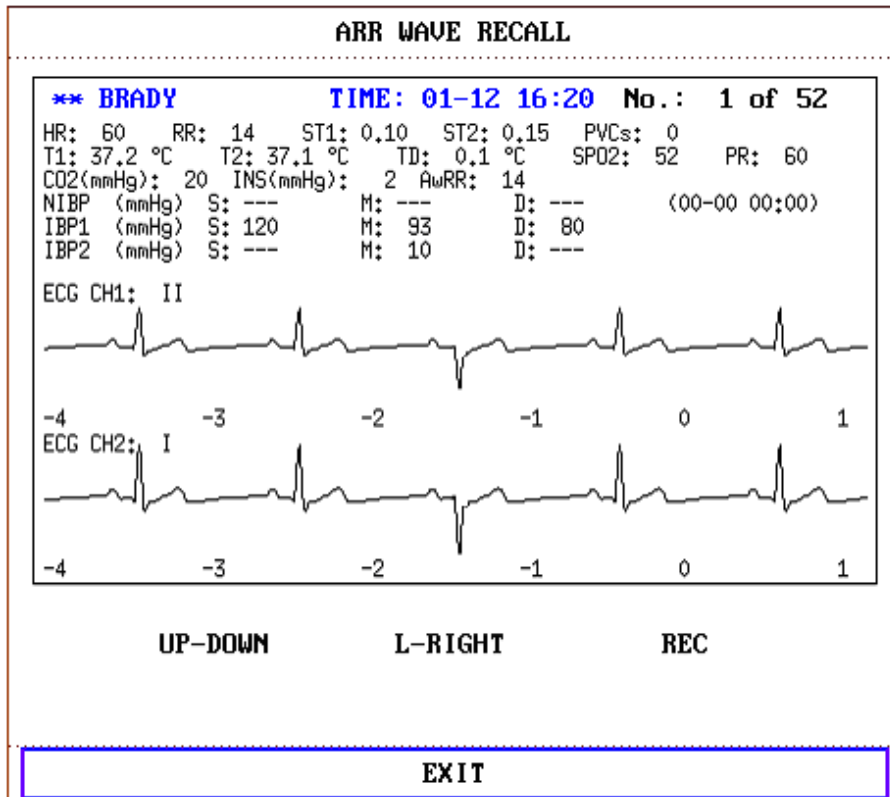

Figure 12-25 ARR WAVE RECALL

**ARR ALARM**

The alarm is triggered when an Arrhythmia occurs. If the **ALM** is **ON**, the alarm sounds and the alarm indicator flashes.

Physiological alarms:

Prompt	Applicable Patient Type	Occurring Condition	Alarm Level
ASYSTOLE	All patients	No QRS is detected for 4 consecutive seconds	User-selectable
VFIB/VTAC	Without pacemaker	Ventricular tachycardia: The fibrillation wave lasts for consecutive 4 seconds; or the number of continuous Vent beats is larger than the upper limit of cluster Vent beats ( $\geq 5$ ).  The RR interval is less than 600ms.	User-selectable
VT>2	Without pacemaker	$3 \leq$ the number of cluster PVCs $< 5$	User-selectable
COUPLET	Without pacemaker	2 consecutive PVCs	User-selectable
BIGEMINY	Without pacemaker	Vent Bigeminy	User-selectable

TRIGEMINY	Without pacemaker	Vent Trigeminy	User-selectable
R ON T	Without pacemaker	A type of single PVC under the condition that HR<100 , R-R interval is less than 1/3 the average interval, followed by a compensating pause of 1.25X the average R-R interval (the next R wave advances onto the previous T wave).	User-selectable
PVC	Without pacemaker	Single PVCs not belonging to the type of above mentioned PVCs.	User-selectable
TACHY	All patients	5 consecutive QRS complex, RR interval is less than 0.5s.	User-selectable
BRADY	All patients	5 consecutive QRS complex, RR interval is longer than 1.5s.	User-selectable
MISSED BEATS	Without pacemaker	When HR is less than 100 beats/min., no heart beat is tested during the period 1.75 times of the average RR interval; or When HR is higher than 100beat/min, no beat is tested within 1 second.	User-selectable
IRR	Without pacemaker	IRREGULAR RHYTHM: The patient has irregular heart rate, check patient's condition, electrodes, cables and leads.	User-selectable
PNC	With pacemaker	PACE NOT CAPTURE: After the pacemaker is paced, QRS complex can not be detected during 300ms.	User-selectable
PNP	With pacemaker	PACER NOT PACED: After the QRS complex, no pace is detected during 1.75 times of RR interval.	User-selectable
VBRADY	Without pacemaker	VENTRICULAR BRADYCARDIA: The patient has irregular HR, and his average HR is less than 60bpm. Check his condition, electrodes, cables and leads.	User-selectable
VENT	Without pacemaker	VENTRICULAR RHYTHM: The patient has irregular heart rate, check patient's condition, electrodes, cables and leads.	User-selectable

Patient type:

All patients: refers to performing Arr.analysis on patients either with pacemakers or without pacemakers.

Without pacemaker: refers to performing Arr. Analysis only on the patients without pacemakers.

With pacemaker: refers to performing Arr. Analysis only on the patients with pacemakers.

Prompt message:

Message	Cause	Alarm Level
ARR LEARNING	The QRS template building required for Arr. Analysis is in process.	No alarm

**NOTE:**

Arrhythmia name displays in the Alarm Message Area.

## 12.9 Measuring RESP

### 12.9.1 How to Measure RESP

The monitor measures respiration from the amount of thoracic impedance between two ECG electrodes. The change of impedance between the two electrodes, (due to the thoracic movement), produces a respiratory waveform on the screen.

### 12.9.2 Setting Up RESP Measurement

For RESP monitoring, it is not necessary for additional electrodes, however, it is very important to attach the electrodes to the correct positions.

Some patients, due to their clinical condition, expand their chest laterally, causing a negative intrathoracic pressure. In these cases it is better to place the two RESP electrodes laterally in the right axillary and left lateral chest areas at the maximum point of breathing movement to optimize the respiratory waveform.

**NOTE:**

The RESP monitoring is not recommended to be used on patients who are very active, as this can cause false alarms.

#### Checklist for RESP Monitoring

1. Prepare the patient's skin prior to placing the electrodes.
2. Attach snap or clip to the electrodes and attach the electrodes to the patient as described below.
3. Switch on the monitor.

### 12.9.3 Installing Electrode for RESP Measurement

#### Placing the Electrodes for Respiratory Monitoring

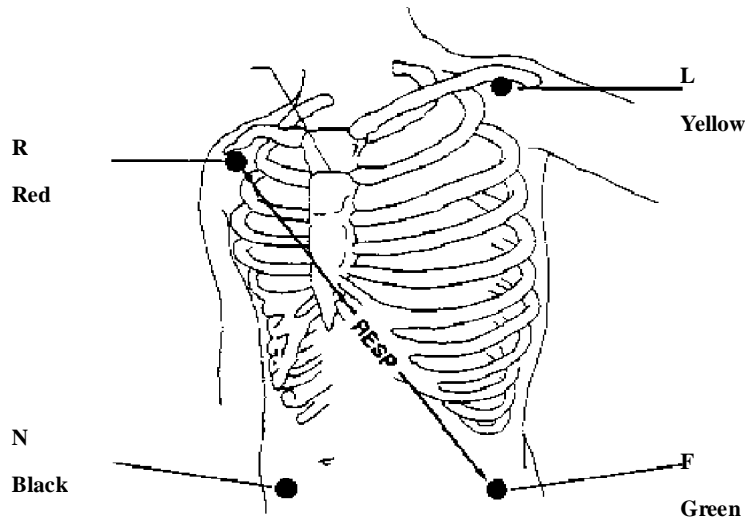

Figure 12-26 Electrodes Placement (5-lead)

**NOTE:**

Place the red and green electrodes diagonally to optimize the respiration waveform. Avoid the liver area and the ventricles of the heart in the line between the RESP electrodes so as to avoid cardiac overlay or artifacts from pulsating blood flow. This is particularly important for neonates.

**12.9.4 RESP SETUP**

Pick RESP hot key on the screen to call up the following menu:

RESP SETUP			
ALM	ON	SWEEP	12.5
ALM LEV	MED	WAVE AMP	1
ALM REC	OFF	HOLD TYPE	AUTO
ALM HI	30	HOLD HI	
ALM LO	8	HOLD LO	
APNEA ALM	20S	DEFAULT >>	
RESP LEAD	LEAD II		
EXIT			

Figure 12-27 RESP Setup

**RESP alarm setting**

- 👁️ **ALM:** pick **ON** to enable prompt message during the RESP alarm; pick **OFF** to disable the alarm function, and there will be a  besides “RESP”.



**WARNING**

In order to avoid endangering the patient's life, the user should use this function cautiously.

- 👁️ **ALM LEV:** selectable from **HIGH**, **MED** and **LOW**. Level **HIGH** represents the most serious case.
- 👁️ **ALM REC:** pick **ON** to enable report printing upon RESP alarm.
- 👁️ **ALM HI:** used to set up the upper alarm limit.
- 👁️ **ALM LO:** used to set up the lower alarm limit.

RESP alarm is activated when the respiration rate exceeds set **ALM HI** value or falls below **ALM LO** value.

Default RESP alarm limits:

	<b>RR HI</b>	<b>RR LO</b>	<b>Step</b>
RESP ADU	30	8	1
RESP PED	30	8	1
RESP NEO	100	30	1

The adjusting range of RESP alarm limits:

	<b>Max. RR HI</b>	<b>Min. RR LO</b>	<b>Step</b>
RESP ADU	120	6	1
RESP PED	150	6	1
RESP NEO	150	6	1

- 👁️ **APNEA ALM:** to set the standard of judging an apnea case. It ranges from 10 to 40 seconds, and increases/decreases by 5.
- 👁️ **RESP LEAD:** set the lead type to lead I or Lead II for respiration.
  - Lead I** : Placing the leads on **R-L** (RA-LA) can measure the thoracic breathing.
  - Lead II** : Placing the leads on **R-F** (RA-LL) can measure the abdominal breathing.

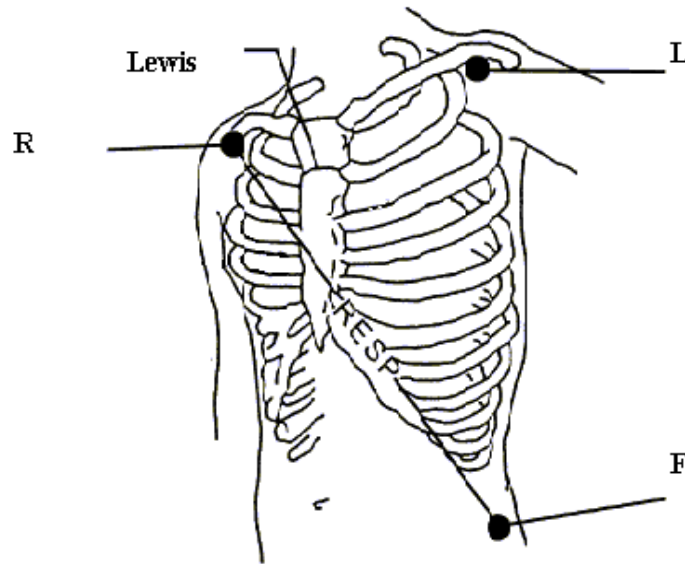

Figure 12-28 Install RESP leads

- 👁 **SWEEP:** Available options for **RESP SWEEP** are 6.25, 12.5, 25.0 and 50.0 mm/s.
- 👁 **WAVE AMP:** The user may set up the displaying amplitude of the RESP waveform. The selections are **0.25/0.5/1/2/3/4/5**. The default setup is **2**.
- 👁 **HOLD TYPE:** can be set to **AUTO** or **MANUAL**. When it is set to **AUTO** mode, the **HOLD HI** and **HOLD LO** are unavailable, and the monitor can calculate the respiration rate automatically. When it is set to **MANUAL** mode, you can adjust the broken lines in RESP area by the **HOLD HI** and **HOLD LO** items.
- 👁 **HOLD HI/LO:** when the **HOLD TYPE** is **MANUAL**, you can adjust the broken lines for higher or lower limit of the respiration rate.
- 👁 **DEFAULT:** pick this item to access the **RESP DEFAULT CONFIG** dialog box, in which the user may select whether the **FACTORY DEFAULT CONFIG** or the **USER DEFAULT CONFIG** is to be used. After selecting any of the items and exiting the dialog box, the system will pop up the dialog box asking for the user's confirmation.

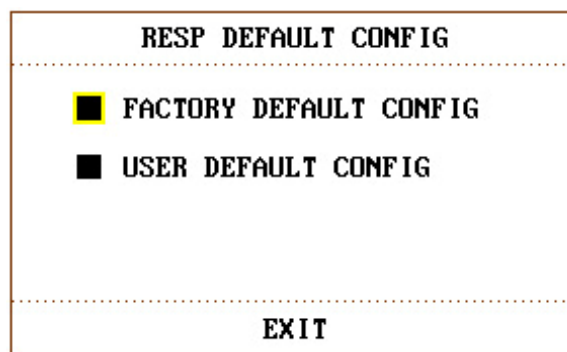

Figure 12-29 RESP default configuration

### **WARNING**

The respiration sensitivity will descend after using the defibrillation cable, and the “4” mode is recommended in the **WAVE AMP**.

## 12.9.5 RESP Alarm Message

Tables below describe the possible physiological alarms messages occurring during RESP measurement.

Physiological alarms:

Message	Cause	Alarm Level
RR HIGH	RESP measuring value is above upper alarm limit.	User-selectable
RR LOW	RESP measuring value is below lower alarm limit.	User-selectable
RESP APNEA	RESP can not be measured within specific time interval.	HIGH

Technical alarms:

Message	Cause	Alarm level	What to do
RESPCOMM STOP	RESP module failure or communication failure	High	Stop using measuring function of RESP module, notify biomedical engineer or the manufacturer's service staff.

## 12.10 Maintenance and Cleaning

### **WARNING**

- 1 Before cleaning the monitor or the sensor, make sure that the equipment is switched off and disconnected from the power line.
- 2 If there is any sign that the ECG cable may be damaged or deteriorated, replace it with a new one instead of continuing its application on the patient.

### **👁 Cleaning:**

Use fine-hair cloth moistened in mild soap liquid or cleaning agent containing 70% ethanol to clean the equipment.

### **👁 Sterilization**

To avoid extended damage to the equipment, sterilization is only recommended when stipulated as necessary in the Hospital Maintenance Schedule. Sterilization facilities should be cleaned first.

Recommended sterilization material:

- ☒ Ethylate: 70% alcohol, 70% isopropanol
- ☒ Acetaldehyde: 3.6%

### **👁 Disinfection**

To avoid extended damage to the equipment, disinfection is only recommended when stipulated as necessary in the Hospital Maintenance Schedule. Disinfection facilities should be cleaned first.



## Chapter 13 SpO<sub>2</sub> Monitoring

### 13.1 What is SpO<sub>2</sub> Monitoring

The monitor uses oximetry to measure functional oxygen saturation in the blood. SpO<sub>2</sub> Plethysmogram measurement is employed to determine the oxygen saturation of hemoglobin in the arterial blood. If, for example, 97% of the hemoglobin molecules in the red blood cells of the arterial blood combine with oxygen, then the blood has a SpO<sub>2</sub> oxygen saturation of 97%. The SpO<sub>2</sub> numeric on the monitor will read 97%. The SpO<sub>2</sub> numeric shows the percentage of hemoglobin molecules which have combined with oxygen molecules to form oxyhemoglobin. The SpO<sub>2</sub>/PLETH parameter can also provide a pulse rate signal and a plethysmogram wave.

#### How the SpO<sub>2</sub>/PLETH Parameter Works

- 👁 Arterial oxygen saturation is measured by a method called pulse oximetry. It is a continuous, non-invasive method based on the different absorption spectra of reduced hemoglobin and oxyhemoglobin. It measures how much light, sent from light sources on one side of the sensor, is transmitted through patient tissue (such as a finger or an ear), to a receiver on the other side.
- 👁 The amount of light transmitted depends on many factors, most of which are constant. However, one of these factors, the blood flow in the arteries, varies with time, because it is pulsating. By measuring the light absorption during a pulsation, it is possible to derive the oxygen saturation of the arterial blood. Detecting the pulsation gives a PLETH waveform and pulse rate signal.
- 👁 The SpO<sub>2</sub> value and the PLETH waveform can be displayed on the main interface.

---

#### **WARNING**

Pulse oximetry can overestimate the SpO<sub>2</sub> value in the presence of Hb-CO, Met-Hb or dye dilution chemicals.

---

#### SpO<sub>2</sub>/Pulse Monitoring

---

#### **WARNING**

- 1 ES (Electrosurgery) equipment wire and SpO<sub>2</sub> cable must not be tangled up.
  - 2 Do not put the sensor on extremities with arterial catheter or venous syringe.
- 

#### **NOTE:**

Do not perform SpO<sub>2</sub> measuring and NIBP measuring on the same arm at one time, because obstruction of blood flow during NIBP measuring may adversely affect the reading of SpO<sub>2</sub> value.

## 13.2 Precautions during SpO<sub>2</sub>/Pulse Monitoring

### **WARNING**

- 1 Verify the sensor cable fault detection before the beginning of monitoring phase. Unplug the SpO<sub>2</sub> sensor cable from the socket, and the screen will display the error message "**SpO<sub>2</sub> SENSOR OFF**" and the audible alarm is activated.
- 2 If the SpO<sub>2</sub> sensor can not work properly, please reconnect the sensor or change a new one.
- 3 Do not use the sterile supplied SpO<sub>2</sub> sensors if the packaging or the sensor is damaged and return them to the vendor.
- 4 Prolonged and continuous monitoring may increase the risk of unexpected change of dermal condition such as abnormal sensitivity, rubescence, vesicle, repressive putrescence, and so on. It is especially important to check the sensor placement of neonate and patient of poor perfusion or immature dermogram by light collimation and proper attaching strictly according to changes of the skin. More frequent examinations may be required for different patients.
- 5 Tissue damage may be caused by incorrect application or prolonged measurement duration using the sensor (more than 4 hours). Inspect the sensor periodically according to the sensor user manual.
- 6 Neonate SpO<sub>2</sub> sensor can only be used when required, no more than 20 min at a time.
- 7 The sensor's applicable wavelengths are 660nm of red light and 895nm of infrared light.
- 8 The sensor accords with the ISO 10993-1 for biocompatibility.

### **NOTE:**

- 1 Make sure the nail covers the light window; The wire should be on the backside of the hand.
- 2 Hand should not be too cold when measuring, and the nail polish should be cleaned before measuring, or the data accuracy may be affected.
- 3 SpO<sub>2</sub> value always displays at the same position. Pulse Rate will display when **HR FROM** is set to "**SpO<sub>2</sub>**", No ECG signal when **HR FROM** is set to AUTO.
- 4 SpO<sub>2</sub> waveform is not proportional to the pulse volume.

## 13.3 Monitoring Procedure

### **SpO<sub>2</sub> plethysmogram measurement**

1. Switch on the monitor.
2. Attach the sensor to the appropriate site of the patient finger.

3. Plug the connector of the sensor extension cable into the SpO<sub>2</sub> socket on the SpO<sub>2</sub> module.

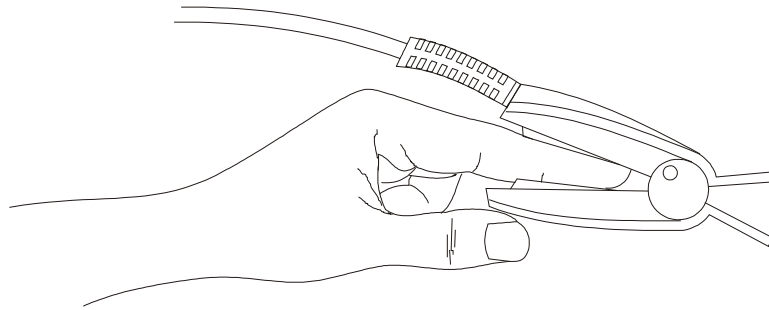

Figure 13-1 Mounting of the Sensor

## 13.4 Limitations for Measurement

In operation, the accuracy of oximetry readings can be affected by:

- 👁 High-frequency electrical noise, including noise created by the host system, or noise from external sources, such as electrosurgical apparatus, which is admitted by the host system.
- 👁 Do not use the monitor and oximetry sensors during magnetic resonance imaging (MRI) scanning. Induced current could potentially cause burns.
- 👁 Intravenous dye
- 👁 Excessive patient movement
- 👁 Outside ray radiation
- 👁 Improper sensor application
- 👁 Sensor temperature (maintain between 28°C and 42°C for best operation )
- 👁 Placement of the sensor on an extremity that has a blood pressure cuff, arterial catheter, or intravascular line
- 👁 Significant concentration of dysfunctional hemoglobin, such as carboxyhemoglobin and methemoglobin
- 👁 Low SpO<sub>2</sub>
- 👁 Circular perfusion is not well for test part
- 👁 It is recommended to use SpO<sub>2</sub> sensors described in Chapter 20 Accessories and Ordering Information.
- 👁 The dissipation power is less than 50μ W, when the sensor temperature is higher than 41 °C, you should shorten the measuring time.

## 13.5 SpO<sub>2</sub> SETUP

Pick the SpO<sub>2</sub> hot key on the main screen to open the **SpO<sub>2</sub> SETUP** as shown below.

SpO <sub>2</sub> SETUP			
ALM	ON	PR ALM LO	50
ALM LEV	MED	SWEEP	12.5
ALM REC	OFF	PR SOUND	2
SpO <sub>2</sub> ALM HI	100	AVG TIME	4S
SpO <sub>2</sub> ALM LO	90	PITCH TONE	ON
PR ALM HI	120	DEFAULT >>	
EXIT			

Figure 13-2 SpO<sub>2</sub> SETUP**WARNING**

Setting the SpO<sub>2</sub> upper alarm limit to 100% is equivalent to switching off the alarm on upper limit. High oxygen levels may predispose a premature infant to retrolental fibroplasia. Therefore, the upper alarm limit for oxygen saturation must be carefully selected in accordance with commonly accepted clinical practices.

**SpO<sub>2</sub> Alarm Setting**

- 👁️ **ALM**: pick **ON** to enable prompt message during the SpO<sub>2</sub> alarm; pick **OFF** to disable the alarm function, and there will be a  besides “SpO<sub>2</sub>”.

**WARNING**

In order to avoid endangering the patient's life, the user should use this function cautiously.

- 👁️ **ALM LEV**: used to set up alarm level, selectable from **HIGH**, **MED** and **LOW**. **HIGH** represents the most serious case.
- 👁️ **ALM REC**: pick **ON** to enable report printing upon SpO<sub>2</sub> alarm.
- 👁️ SpO<sub>2</sub> alarm is activated when the result exceeds **SpO<sub>2</sub> ALM HI** value or falls below **SpO<sub>2</sub> ALM LO** value. Use the knob to pick the **SpO<sub>2</sub> ALM HI** or **SpO<sub>2</sub> ALM LOW** item and turn the knob to select the desired alarm limit.
- 👁️ PR alarm is activated when the pulse rate exceeds **PR ALM HI** value or falls below **PR ALM LO** value. Use the knob to pick the **PR ALM HI** or **PR ALM LOW** item and turn the knob to select the desired alarm limit.



Default SpO<sub>2</sub> alarm limits:

	Max. Upper Limit	Min. Lower Limit	Step
ADU	100	90	1
PED	100	90	1
NEO	95	88	1

Default PR alarm limits:

	Max. Upper Limit	Min. Lower Limit	Step
ADU	120	50	1
PED	160	75	1
NEO	200	100	1

#### 👁 SWEEP

Available options for SpO<sub>2</sub> SWEEP are 6.25, 12.5, 25.0 and 50.0mm/s.

#### 👁 PR SOUND

It indicates the Pulse beep volume. Options are “0 - 5”.

#### 👁 SENSITIVITY

HIGH, MED and LOW are three options available.

#### 👁 PITCH TONE

When ON is enabled, the system will provide prompt sound with different tone for clinic under complex monitoring environment, based on the variance of SpO<sub>2</sub> value.

#### 👁 DEFAULT

Pick this item to access the SpO<sub>2</sub> DEFAULT CONFIG dialog box, in which the user may select whether the FACTORY DEFAULT CONFIG or the USER DEFAULT CONFIG is to be used. After selecting any of the items and exiting the dialog box, the system will pop up the dialog box asking for the user’s confirmation.

## 13.6 Alarm Description

### SpO<sub>2</sub> Alarm Message

Tables below describe the possible physiological alarms, technical alarms occurring during SpO<sub>2</sub> measurement.

When there is no SpO<sub>2</sub> or PR input, a prompt is displayed, indicating the signal is weak.

Physiological alarm:

Message	Cause	Alarm Level
SpO <sub>2</sub> HIGH	SpO <sub>2</sub> measuring value is above upper alarm limit.	User-selectable
SpO <sub>2</sub> LOW	SpO <sub>2</sub> measuring value is below lower alarm limit.	User-selectable
PR HIGH	PR measuring value is above upper alarm limit.	User-selectable
PR LOW	PR measuring value is below lower alarm limit.	User-selectable

Technical alarms:

Message	Cause	Alarm Level	What to do
SpO <sub>2</sub> SENSOR OFF	SpO <sub>2</sub> sensor may be disconnected from the patient or the monitor.	Low	Make sure the sensor is well connected to the patient's finger or other parts.
SpO <sub>2</sub> NO SENSOR	SpO <sub>2</sub> sensor was not connected well, or the connection is loose.	Low	Make sure the monitor and sensor is well connected, reconnect the sensor.
SpO <sub>2</sub> SEARCH PULSE	SpO <sub>2</sub> sensor may be disconnected from the patient or the monitor.	Low	If the Pulse is not displayed after 30s, check the connection between the sensor and the patient's finger, reconnect the sensor or change it to other parts.
SpO <sub>2</sub> COMM STOP	SpO <sub>2</sub> module failure or communication failure	High	Stop using measuring function of SpO <sub>2</sub> module, notify biomedical engineer or Manufacturer's service staff.

## 13.7 Maintenance and Cleaning

### **WARNING**

- 1 Before cleaning the monitor or the sensor, make sure that the equipment is switched off and disconnected from the power line.
- 2 Do not subject the sensor to autoclaving. Do not immerse the sensor into any liquid. Do not use any sensor or cable that may be damaged or deteriorated.

- Use a cotton ball or a soft mull moistened with hospital-grade ethanol to wipe the surface of the sensor, and then dry it with a cloth. This cleaning method can also be applied to the

luminotron and receiving unit.

- The cable can be cleaned with 3% hydrogen dioxide, 70% isopropanol, or other active reagent. However, connector of the sensor shall not be subjected to such solutions.



## Chapter 14 NIBP Monitoring

### 14.1 Introduction

- ① The Non-invasive Blood Pressure (NIBP) module measures the blood pressure using the oscillometric method.
- ① It is applicable for adult, pediatric, and neonatal patients.
- ① There are three modes of measurement available: manual, automatic and continual. Each mode displays the diastolic, systolic, mean blood pressure and pulse rate.
- ∞ In the **MANUAL** mode, only one measurement is conducted at a time.
- ∞ In the **AUTO** mode, the measurement is cycled; you can set the time interval to **1/2/3/4/5/10/15/30/60/90/120/240/480** minutes.
- ∞ In the **CONTINUAL** mode, the system executes NIBP measurement continuously within five minutes.

#### NOTE:

- 1 Please confirm the result by referring to patients' condition if the measurement fails or if the measurements are questionable.
- 2 Once the measurement limits are exceeded or patients' condition deteriorates, you may check if the tube is twisted or is blocked.

---

#### **WARNING**

- 1 You must not perform NIBP measurement on the patients with sickle-cell disease or on the patients whose skin is damaged or anticipated to be damaged.
  - 2 For a thrombosthemia patient, it is important to determine whether measurement of the blood pressure shall be done automatically. The determination should be based on the clinical evaluation.
  - 3 Ensure that the correct mode is selected when performing measurements on children or neonates. (For more information, please refer to the sections about menu setting.) Incorrect patient mode setting could do harm on patients. It may be dangerous for children and neonates to use an over pressure level.
  - 4 The equipment is applicable in electrosurgery.
  - 5 The equipment can provide protective means to prevent the patient from being burned when used with HF SURGICAL EQUIPMENT.
  - 6 The equipment can protect against the effects of the discharge of a defibrillator.
  - 7 The continuous measuring and calibration can not be operated on neonatal or pediatric patients, nor in **AUTO** measurement mode.
  - 8 Please do select the correct patient mode and the suitable cuff in case any damage will be caused by wrong operation or over pressure.
  - 9 Repetition of measuring in the short interval automatic mode may cause discomfort in limbs.
-

## 14.2 NIBP Monitoring

### 14.2.1 NIBP Measurement

---

**WARNING**

---

- 1 Prior to a measurement, verify that you have selected a setting appropriate for your patient (adult, child or neonate.)
  - 2 Do not apply the cuff to the limb that is intravenously infused or is catheterized. This could cause tissue damage around the catheter when infusion is slowed or blocked during cuff inflation.
  - 3 Make sure that the air conduit connecting the blood pressure cuff and the monitor is neither blocked nor tangled. If the air inside the cuff cannot be vented, it may cause twig dysfunction due to the lack of blood in the limbs.
- 

#### Measurement with M3600 Module

1. Plug the air hose into the connector for blood pressure measurement and connect it by turning it clockwise. (To demount the air hose, you should turn it widdershins.) Switch on the system after you .verify the air hose has been well connected.
2. Apply the blood pressure cuff to the patient's arm as Figure14-1 shows.
  - 👁 Ensure that the cuff is completely deflated.
  - 👁 Apply the cuff with an appropriate size to the patient, and make sure that the symbol " " is right over the artery. Ensure that the cuff is not wrapped too tightly nor too loosely around the limb. In terms of the standard cuff assorted for this monitor, you may judge its suitability by inserting two fingers into the wrapped cuff.

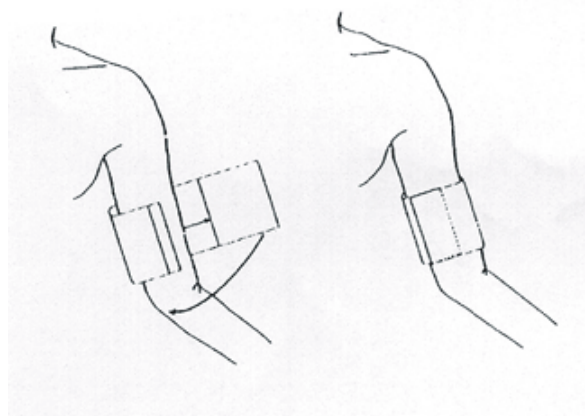
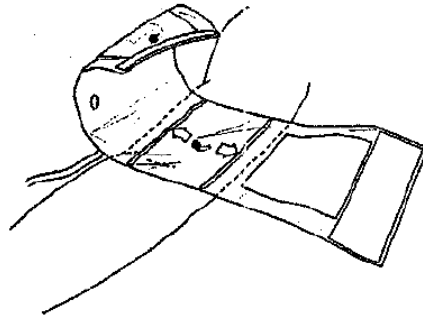
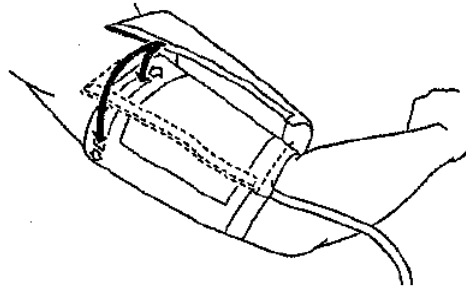

Figure 14-1 Applying Cuff

- 👁 Arrows symbols are marked at the inner side of the cuff between the two lines as below:



- ① The write lines as markers can be found at the edge outside the cuff. If the end of the cuff is not able to be attached within this marked range, please select another cuff with a suitable size.



**NOTE:**

- 1 Please make sure the cuff is well connected. A leak of air may cause measurement error.
- 2 Please select the cuff with the suitable size. An unsuitable cuff may cause incorrect measurements.
- 3 Do not disinfect the cuff with radiation or gas, or the cuff will be deteriorated.
- 4 Avoid incursion of liquid into the cuff. If this happens, please desiccate the cuff completely.

Size of reusable cuffs for adults/ children/:

Patient Type	Limb Perimeter	Cuff Width	Hose
Adult No.1	12 cm ~ 18 cm	7 cm	3.5 m
Adult No.2	17 cm ~ 23 cm	9 cm	
Adult No.3	23 cm ~ 33 cm	12 cm	
Adult No.4	31 cm ~ 40 cm	14 cm	

Size of disposable cuff for neonates:

Size No.	Limb Perimeter	Cuff Width	Hose
1	3.5 cm ~ 6.0 cm	2.5 cm	3.5 m
2	5.0 cm ~ 7.5 cm	3.0cm	
3	7.5 cm ~ 10.5 cm	4.0cm	
4	8.5 cm ~ 13.0 cm	5.0cm	

3. Connect the air hose with the cuff by turning it clockwise. (To demount the air hose, you should turn it widdershins.)
4. Check whether the patient mode is appropriately selected. Access **PATIENT SETUP** menu from **SYSTEM MENU** and pick **PAT TYPE** item and turn the knob to select the required patient type.
5. Select a measurement mode in the **NIBP SETUP** menu. Refer to the following paragraphs **Operation Hints** for details.
6. Press the “**Start**” button on the front panel to start a measurement.

### Measurement with V6 Module

1. Plug in the air hose and switch on the system.
2. Apply the blood pressure cuff to the patient's arm or leg following the instructions below (Figure 14-2).
  - Ensure that the cuff is completely deflated.
  - Apply the appropriate size cuff to the patient, and make sure that the symbol " " is over the appropriate artery. Ensure that the cuff is not wrapped too tightly around the limb. Excessive tightness may cause discoloration and eventual ischemia of the extremity.

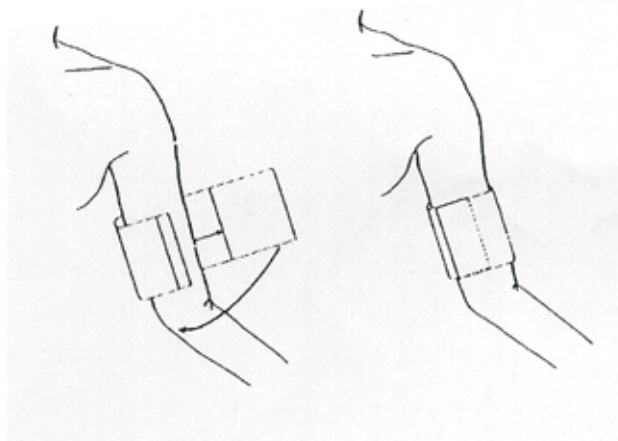

Figure 14-2 Applying Cuff

#### NOTE:

The width of the cuff should be either 40% of the limb circumference (50% for neonates) or 2/3 of the upper arm length. The inflatable part of the cuff should be long enough to encircle 50-80% of the limb. The wrong size of cuff can cause erroneous readings. If the cuff size is in question, then use a larger cuff.

Size of reusable cuffs for neonates/children/adults:

Patient Type	Limb Perimeter	Cuff Width	Hose
Infant	10 cm ~19 cm	8 cm	1.5 m or 3 m
Child	18 cm ~ 26 cm	10.6 cm	
Adult	25 cm ~ 35 cm	14 cm	
Large Adult	33 cm ~ 47 cm	17 cm	
Thigh	46 cm ~ 66 cm	21 cm	

Size of disposable cuff for neonate/children/adult:

Size No.	Limb perimeter	Cuff width	Hose
1	3.1 cm ~ 5.7 cm	2.5 cm	1.5 m or 3 m
2	4.3 cm ~ 8.0 cm	3.2 cm	
3	5.8 cm ~ 10.9 cm	4.3 cm	
4	7.1 cm ~ 13.1 cm	5.1 cm	

The lifespan of cuff is: 480mmHg/20000 times; 300mmHg/50000 times.

- ① Make sure that the cuff edge falls within the range of the mark <->. If it does not, use a larger or smaller cuff that fits better.
3. Connect the cuff to the air hose. The limb chosen for taking the measurement should be placed at the same level as the patient's heart. If this is not possible you should apply the following corrections to the measured values:
    - ① If the cuff is placed higher than the heart level, add 0.75 mmHg (0.10 kPa) for each inch of difference.
    - ② If it is placed lower than the heart level, deduct 0.75 mmHg (0.10 kPa) for each inch of difference.
  4. Check whether the patient mode is appropriately selected. Access **PATIENT SETUP** menu from **SYSTEM MENU** and pick **PAT TYPE** item and turn the knob to select the required patient type.
  5. Select a measurement mode in the **NIBP SETUP** menu. Refer to the following paragraphs **Operation Hints** for details.
  6. Press the “**Start**” button on the front panel to start a measurement.

### Operation Hints

1. To start auto measurement:  
Access **NIBP SETUP** menu and pick the **INTERVAL** item, in which the user may choose



the options other than **MANUAL** to set up the time interval for auto measurement. After that, press the “**Start**” button on the front panel to start the **AUTO** measurement according to the selected time interval.

---

### **WARNING**

Prolonged non-invasive blood pressure measurements in Auto mode may be associated with purport, ischemia and neuropathy in the limb wearing the cuff. When monitoring a patient, examine the extremities of the limb frequently for normal color, warmth and sensitivity. If any abnormality is observed, stop the blood pressure measurement.

---

2. To stop auto measurement:  
During auto measurement, press the “**Start**” button on the front panel at any time to stop auto measurement.
3. To start a manual measurement:
  - 👁 Access **NIBP SETUP** menu and pick the **INTERVAL** item. Select the **MANUAL** option. Then press the **Start** button on the front panel to start a manual measurement.
  - 👁 During the idle period of auto measurement process, press the **Start** button on the front panel at any time to start a manual measurement. Then press the **Start** button on the front panel to stop manual measurement and the system continues to execute auto measurement program according to the selected time interval.
4. To start a manual measurement during the **AUTO** mode:  
Press the **Start** button on the front panel.
5. To stop a manual measurement:  
Repress the **Start** button on the front panel.
6. To start a continuous measurement:  
Access the **NIBP SETUP** menu and pick the **CONTINUAL** item to start a continuous measurement. The continuous measurement will last 5 minutes.

---

### **WARNING**

Prolonged non-invasive blood pressure measurements in Auto mode may be associated with purport, ischemia and neuropathy in the limb wearing the cuff. When monitoring a patient, examine the extremities of the limb frequently for normal color, warmth and sensitivity. If any abnormality is observed, stop the blood pressure measurements.

---

7. To stop continuous measurement:  
During continuous measurement press the **Start** button on the front panel at any time to stop continuous measurement.

#### **NOTE:**

If you are in doubt about the accuracy of any reading(s), check the patient's vital signs by an alternative method before checking the functioning of the monitor.

**WARNING**

If liquid is inadvertently splashed on the equipment or its accessories, or enters the conduit or inside the monitor, contact local Customer Service Center.

**Measurement Limitations**

For different patients, the oscillometric measurement has different limitations. The measurement is in search of regular arterial pressure pulse. In those circumstances when the patient's condition makes it difficult to detect, the measurement becomes unreliable and the measuring time increases. The user should be aware that the following conditions could interfere with the measurement, making the measurement unreliable or longer to derive.

In the following cases, the patient's condition will make a measurement impossible:

- Measurement will be impossible under the circumstances of bad peripheral circulation, low blood pressure or low body temperature.
- Measurements will be impossible if the patient has frequent cardiac arrhythmia.
- Measurements will be impossible if the patient is connected to a heart-lung machine.

In the following cases, measurements may be incorrect:

- Measurements may be incorrect if there is movement caused by cardiac massage, external continual quivering or convulsions of the patients.
- Measurement may be incorrect if using the cuffs with an unsuitable size.
- Measurement may be incorrect if the cuff is not attached to the appropriate position that should be at the same height of the patient's heart. A deviation of 10cm in height may cause a discrepancy of 7mmHg~8mmHg in the measurements of blood pressure.
- Measurement may be incorrect while the patient is moving or speaking.
- Measurement may be incorrect if the patient wears too much clothes.
- Measurement may be incorrect if the rolled-up sleeve of the clothes presses the arm.

**14.2.2 NIBP Parameter Setup and Adjustment**

NIBP measurements and the corresponding message are displayed as follows:

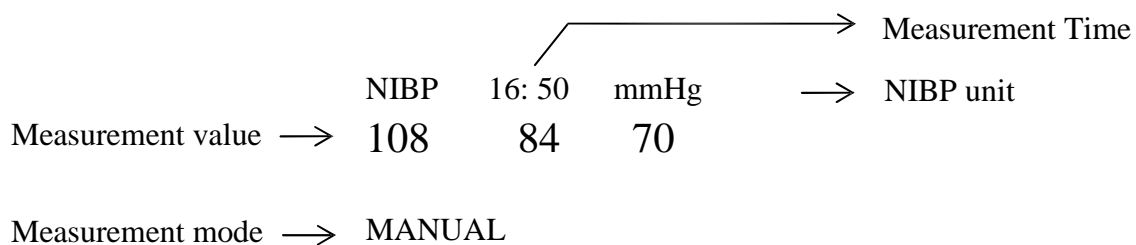

**14.3 NIBP SETUP**

Pick the NIBP hot key on the main screen to open the **NIBP SETUP** shown as below:

NIBP SETUP			
ALM	ON	PR(NIBP)	OFF
ALM LEV	MED	UNIT	mmHg
ALM REC	OFF	INTERVAL	Manual
SYS ALM HI	160	MEASURE SPEED	NORMAL
SYS ALM LO	90	PRESSURE SET MODE	SMART
DIA ALM HI	90	INFLATION VALUE	180
DIA ALM LO	50	CONTINUAL	
MAP ALM HI	110	DEFAULT >>	
MAP ALM LO	60		
NIBP DISPLAY	SINGLE		
EXIT			

M3600 Module

NIBP SETUP			
ALM	ON	PR(NIBP)	OFF
ALM LEV	MED	UNIT	mmHg
ALM REC	OFF	INTERVAL	Manual
SYS ALM HI	160	RESET	
SYS ALM LO	90	CONTINUAL	
MAP ALM HI	110	CALIBRATE	
MAP ALM LO	60	PNEUMATIC	
DIA ALM HI	90	DEFAULT >>	
DIA ALM LO	50		
NIBP DISPLAY	MULTI		
EXIT			

V6 Module

Figure 14-3 NIBP SETUP

④ NIBP alarm setting

- 👁️ **ALM:** pick **ON** to enable prompt message during the NIBP alarm; pick **OFF** to disable the alarm function, and there will be a  besides **NIBP**.

**WARNING**

In order to avoid endangering the patient's life, the user should use this function cautiously.

- 👁️ **ALM LEV**: selectable from **HIGH, MED** to **LOW**. **HIGH** represents the most serious case.
- 👁️ **ALM REC**: pick **ON** to enable report printing upon NIBP alarm.
- 👁️ **SYS ALM HI, SYS ALM LO, MAP ALM HI, MAP ALM LO, DIA ALM HI, DIA ALM LO** are for the user to set up the alarm limit for each type of pressure. NIBP alarm is activated when the pressure exceeds the set upper alarm limit or falls below lower alarm limit.

Default NIBP alarm limits:

	ADU/PED		NEO	
	Lower Limit	Upper Limit	Lower Limit	Upper Limit
SYS	90	160	40	90
DIA	50	90	20	60
MAP	60	110	25	70

The adjusting range of NIBP alarm limits:

Adult/Pediatric Mode

SYS 40 mmHg ~ 270 mmHg  
 DIA 10 mmHg ~ 215 mmHg  
 MAP 20 mmHg ~ 235 mmHg

Neonatal Mode

SYS 40 mmHg ~ 135 mmHg  
 DIA 10 mmHg ~ 100 mmHg  
 MAP 20 mmHg ~ 110 mmHg

ALARM SETUP			
ALM SEL	NIBP ALM SETUP		
ALM	ON	MAP ALM HI	110
ALM LEV	MED	MAP ALM LO	60
ALM REC	OFF	DIA ALM HI	90
SYS ALM HI	160	DIA ALM LO	50
SYS ALM LO	90		
EXIT			

Figure 14-4 ALARM SETUP

The setting range:

👁 **MEASURE SPEED**

**HIGH** and **NORMAL** are two mode options available. **HIGH** mode enables quicker deflation, while **NORMAL** mode is of better performance. Both the two modes can meet the requirement for performance.

👁 **INFLATION VALUE**

It is used to set the initial inflation value. In the non-smart inflation mode, the inflation value for the first blood pressure measurement is the set value.

👁 **UNIT**

Options include **mmHg** and **kPa**.

👁 **INTERVAL**

It is used to set time interval for automatic measuring. Available selections include **1/2/3/4/5/10/15/30/60/90/120/240/480** min. Press **START** button to start the first auto measuring. Pick **MANUAL** selection in **INTERVAL** item to set up the measuring mode to **MANUAL**.

👁 **RESET**

It is used to restore measurement status. Pick this item to restore initial settings of the pressure pump. When the pressure does not work properly and the system fails to give a message for the problem, pick this item to activate self-test procedure, and thus restore the system from abnormal performance.

👁 **CONTINUAL**

It is used to start continuous measuring. Once this function is activated, the menu will not be shown on the screen and continual measurement will perform immediately.

👁 **NIBP MAINTAIN**

A password is required to access this menu.

👁 **DEFAULT CONFIG**

It enables you to access the menu for default configuration of NIBP. Two options are available: factory default config and user default config. A dialog box will pop up for your confirmation after either option is selected.

---

### **WARNING**

---

The calibration of the NIBP measurement should be performed once per year. (Or you may carry out the calibration according to the maintaining policy of your hospital.)

---

## **14.4 NIBP Alarm Message and Prompt Message**

Tables below illustrate the possible physiological alarms, technical alarms and prompt messages occurring during NIBP measurement.

## Alarm and Prompt Messages in M3600 Module

Physiological alarms:

Message	Cause	Alarm Level
NS HIGH	NIBP SYS measuring value is above upper alarm limit.	User-selectable
NS LOW	NIBP SYS measuring value is below lower alarm limit.	User-selectable
ND HIGH	NIBP DIA measuring value is above upper alarm limit.	User-selectable
ND LOW	NIBP DIA measuring value is below lower alarm limit.	User-selectable
NM HIGH	NIBP MAP measuring value is above upper alarm limit.	User-selectable
NM LOW	NIBP MAP measuring value is below lower alarm limit.	User-selectable

Technical alarms: (display in the area below the NIBP value)

Message	Cause	Alarm Level	What to do
NM ALM LMT ERR	Functional safety failure	High	Stop using measuring function of NIBP module, notify biomedical engineer or Manufacturer's service staff.
ND ALM LMT ERR	Functional safety failure		
NIBP COMM STOP	NIBP module failure or communication failure		
NIBP COMM ERR	NIBP module failure or communication failure		
C11 CHECK CUFF	The cuff pressure did not reach the set value with 60sec. (20sec in Neo mode.)	Low	Check the connections and the wrapped cuff to see whether they are all prepared well.
C12 CHECK PAT/CUFF	The pressure dropped to 10mmHg (5mmHg in Neo mode).	Low	Retry twice. Check the patient's condition and the connection of the cuff.
C13 ARTIFICIAL MOVEMENT	The air was not discharged for longer than 15sec because of body movement.	Low	Retry twice. Check for hyperkinesia or arrhythmia.

C14 PRESSURE LOW	The module was not able to detect the SYSTOLIC.	Low	Inflate again and retry thrice. Check whether the patient has a over high blood pressure or it is interfered by movement.
C15 PLUSE ABNORMAL	Abnormal oscillometric waveform was detected.	Low	Retry twice. Check for hyperkinesia or arrhythmia.
C16 PLUSE WEAK	Impossible to measure due to noise by arrhythmia or body movement.	Low	
C17 MEASURE TIMEOUT	Measurement took more than 160sec (80sec in Neo mode).	Low	To find the factors causing pressure obstruction, such as the patient's movement or the twisted tube.
C18 TIMEOUT(PR > 100)	More than 100 pulsed were detected during measurement.	Low	Retry once. Check the patient's condition and the connection of the cuff.
C19 PRESSURE ERROR	Cuff pressure rose above 300mmHg in adult mode (150mmHg in Neo mode).	Low	Check the connection of the cuff to see whether it is twisted.
C20 PLUSE SIGNAL WEAK	The cuff is too loose or pulse is too low to measure.	Low	Check the patient's condition or the wrapped cuff.
C21 CHECK CUFF SIZE	The selected cuff is not suitable for the patient. For example, neonatal cuff is used during inflation in adult mode.	Low	Retry twice. Confirm the patient type and the size of the selected cuff.
NIBP INNER ERROR	A critical error occurs in the blood pressure module.	Low	Stop measuring.

Prompt message: (display in the prompt area below NIBP value)

Message	Cause	Alarm Level
Manual measuring...	It is in the process of manual measuring.	No alarm
Cont measuring...	It is in the process of continual measuring.	
Auto measuring...	It is in the process of automatic measuring.	
Measurement over	Measurement is over.	

Calibrating...	It is in the process of calibrating.	No alarm
Calibration over	Calibration is over.	
Pneum testing...	It is in the process of pneumatic testing.	
Pneum test over	Pneumatic test is over.	
INFLATION TESTING	It is in the process of inflation testing.	
INFLATION TEST OVER	Inflation test is over.	
DEFLATION TESTING	It is in the process of deflation testing.	
DEFLATION TEST OVER	Deflation test is over.	
ENTER MAINTAIN MODE	It is entering the maintain mode.	
ENTER MEASURE MODE	It is entering the measuring mode.	
Please start	Start another measurement by pressing this button.	

### Alarm and Prompt Messages in V6 Module

Physiological alarms:

Message	Cause	Alarm Level
NS HIGH	NIBP SYS measuring value is above upper alarm limit.	User-selectable
NS LOW	NIBP SYS measuring value is below lower alarm limit.	User-selectable
ND HIGH	NIBP DIA measuring value is above upper alarm limit.	User-selectable
ND LOW	NIBP DIA measuring value is below lower alarm limit.	User-selectable
NM HIGH	NIBP MAP measuring value is above upper alarm limit.	User-selectable
NM LOW	NIBP MAP measuring value is below lower alarm limit.	User-selectable



Technical alarms: (display in the area below the NIBP value)

Message	Cause	Alarm Level	What to do
NIBP COMM STOP	NIBP module failure or communication failure	High	Stop using measuring function of NIBP module, notify biomedical engineer or Manufacturer's service staff.
NIBP COMM ERR	NIBP module failure or communication failure	High	
LOOSE CUFF	Cuff is no properly wrapped or no cuff exists.	Low	Properly wrap the cuff
AIR LEAK	Cuff, hose or connector is damaged.	Low	Check and replace the leaking parts, if required, notify biomedical engineer or manufacturer's service staff.
WEAK SIGNAL	Cuff is too loose or patient pulse is too weak.	Low	Use other method to measure blood pressure.
EXCESSIVE MOTION	After by arm motion, signal noise is too large or pulse rate is not regular.	Low	Make sure that the patient under monitoring is motionless.
OVER PRESSURE	Pressure has exceeded the specified upper safety limit.	Low	Measure again, if failure persists, stop using measuring function of NIBP module and notify biomedical engineer or manufacturer's service staff.
SIGNAL SATURATED	Excessive motion.	Low	Stop the patient from moving.
PNEUMATIC LEAK	During pneumatic test, leak is detected.	Low	Check and replace the leaking parts, if required, notify biomedical engineer or manufacturer's service staff.
INIT PRESSURE HIGH	The initial pressure is too high during measuring	High	Measure again, if failure persists, stop using measuring function of NIBP module and notify biomedical engineer or manufacturer's service staff.

NIBP ILLEGAL RESET	The hardware pressure is too high	Low	Measure again, if failure persists, stop using measuring function of NIBP module and notify biomedical engineer or manufacturer's service staff.
MEASURE ABEND	The measurement stop abnormally	High	
NIBP TIME OUT	Measuring time has exceeded 120 seconds (adult) or 90 seconds (neonatal).	Low	Measure again or use other measuring method.

Prompt message: (display in the prompt area below NIBP value)

Message	Cause	Alarm Level
Manual measuring...	It is in the process of measuring.	No alarm
Auto measuring...	It is in the process of automatic measuring.	
Measurement over	Measurement is over.	
Calibrating...	It is in the process of calibrating.	
Calibration over	Calibration is over.	
Pneum testing...	It is in the process of pneumatic testing.	
Pneum test over	Pneumatic test is over.	
Resetting...	NIBP module is resetting.	
Reset failed	NIBP module reset failed.	

## 14.5 Maintenance and Cleaning

### **WARNING**

- 1 Do not squeeze the rubber tube on the cuff.
- 2 Do not allow liquid to enter the connector socket at the front of the monitor.
- 3 Do not wipe the inner part of the connector socket when cleaning the monitor.
- 4 When the reusable cuff is not connected with the monitor, or being cleaned, always place the cover on the rubber tube to avoid liquid permeation.

### Reusable Blood Pressure Cuff (for M3600 Module)

The cuff cannot be sterilized, but it can be cleared following the below method:

Remove the dirt off the surface with 30 ~ 50% isopropyl alcohol solution or 70% alcohol solution. Or immerse it into the mild detergent solution to clear it. Remember to remove the rubber bag if you use this method. The cuff should not be dry-cleaned. The cuff can also be machine-washed or hand-washed; the latter method may prolong the service life of the cuff. Before washing, remove the latex rubber bag, and for machine-washing, close the Velcro fastening. Allow the cuff to dry thoroughly after washing, and then reinsert the rubber bag.

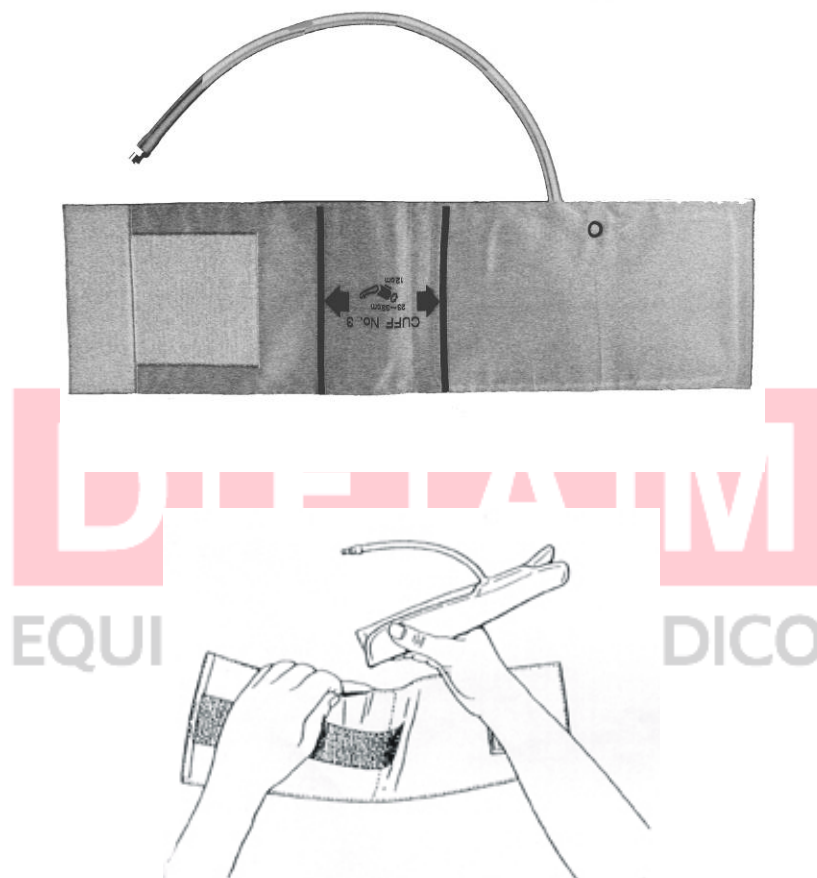

Replace Rubber Bag in Cuff (For M3600 module)

To replace the rubber bag in the cuff, first place the bag on top of the cuff so that the rubber tubes line up with the large opening on the long side of the cuff. Now roll the bag lengthwise and insert it into the opening on the long side of the cuff. Hold the tubes and the cuff and shake the complete cuff until the bag is in position. Thread the rubber tubes from inside the cuff, and out through the small hole under the internal flap.

### Reusable Blood Pressure Cuff (for V6 Module)

The cuff can be sterilized by means of conventional autoclaving, gas, or radiation sterilization in hot air ovens or disinfected by immersion in decontamination solutions, but remember to remove the rubber bag if you use this method. The cuff should not be dry-cleaned.

The cuff can also be machine-washed or hand-washed, the latter method may prolong the service life of the cuff. Before washing, remove the latex rubber bag, and for machine-washing, close the

Velcro fastening. Allow the cuff to dry thoroughly after washing, and then reinsert the rubber bag.

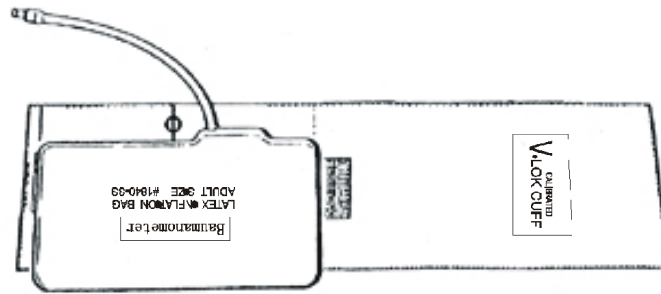

Replace Rubber Bag in Cuff

To replace the rubber bag in the cuff, first place the bag on top of the cuff so that the rubber tubes line up with the large opening on the long side of the cuff. Now roll the bag lengthwise and insert it into the opening on the long side of the cuff. Hold the tubes and the cuff and shake the complete cuff until the bag is in position. Thread the rubber tubes from inside the cuff, and out through the small hole under the internal flap.

### Disposable Blood Pressure Cuffs

Disposable cuffs are intended for one-patient use only. Do not use the same cuff on any other patient. Do not sterilize or use autoclave on disposable cuffs. Disposable cuffs can be cleaned using soap solution to prevent infection.

#### NOTE:

For protecting environment, the disposable blood pressure cuffs must be recycled or disposed of properly.

## Chapter 15 TEMP Monitoring

### 15.1 TEMP Monitoring

Two TEMP probes can be used simultaneously to measure two TEMP data, and get the temperature difference. The standard configuration is axilla sensor for adult.

#### TEMP Monitoring Setup

- 👁 If you are using disposable TEMP probes you need to plug the TEMP cable into the monitor and then connect the probe to the cable. With a reusable TEMP probe you can plug the probe directly into the monitor.
- 👁 Apply the TEMP probes securely to the patient.
- 👁 Switch on the system.

It takes 2 min ~ 3 min for the body temperature to stabilize.

---

#### **WARNING**

- 1 Verify probe cables fault detection before the beginning of monitoring phase. Unplug the temperature probe cable of the channe1 from the socket, and then the screen will display the error message **TEMP1 SENSOR OFF** and the audible alarm is activated. It is the same to the other channel.
  - 2 The calibration of the temperature module is necessary every two years (or as frequently as dictated by your Hospital Procedures Policy). When you need to calibrate the temperature measurement, please contact the manufacturer.
  - 3 Take the TEMP probe and cable carefully. When they are not in use, you should coil up the probe and cable into a loose circle. If the wire inside the cable is tensely pulled, it may cause mechanical damage to the probe and the cable.
- 

#### **NOTE:**

Disposable TEMP probe can only be used once for one patient.

### 15.2 TEMP SETUP

Pick the **TEMP** hot key on the screen to call up the **TEMP SETUP** menu shown as below:

TEMP SETUP			
ALM	ON	T2 ALM HI	39.0
ALM LEV	MED	T2 ALM LO	36.0
ALM REC	OFF	TD ALM HI	2.0
T1 ALM HI	39.0	TEMP UNIT	°C
T1 ALM LO	36.0	DEFAULT >>	
EXIT			

Figure 15-1 TEMP SETUP

- ALM: pick **ON** to enable prompt message during the TEMP alarm; pick **OFF** to disable the alarm function, and prompt the  symbol besides TEMP numeric.

**WARNING**

In order to avoid endangering the patient’s life, the user should use this function cautiously.

- ALM LEV: used to set up the alarm level, selectable from **HIGH, MED** or **LOW**.
- ALM REC: used to start/stop recording TEMP alarms. Pick **ON** to enable report printing upon TEMP alarm.
- Alarm for T1, T2, TD occurs when the measured temperature exceeds the set alarm upper limit or falls below alarm lower limit.

T1 represents the TEMP of Channel 1, T2 represents the TEMP of Channel 2, TD represents the TEMP difference of T1 and T2.

The adjusting range of T1, T2 and TD alarm limits is: 0 ~ 50°C.

Default T1 and T2 alarm limits:

	TEMP HI	TEMP LO	Step
ADU/PED/NEO	39°C	36°C	0.1

Default TD alarm limits:

	TEMP HI	Step
ADU/PED/NEO	2°C	0.1

- 👁 **UNIT:** To set temperature unit (°C or °F).
- 👁 **DEFAULT:** Pick this item to access the **TEMP DEFAULT CONFIG** dialog box, in which the user may select whether the **FACTORY DEFAULT CONFIG** or the **USER DEFAULT CONFIG** is to be used. After selecting any of the items and exiting the dialog box, the system will pop up the dialog box asking for the user's confirmation.

### 15.3 TEMP Alarm Message

Tables below describe the possible physiological alarms, technical alarms occurring during TEMP measurement.

Physiological alarms:

Message	Cause	Alarm Level
T1 HIGH	Measuring value of T1 channel is above upper alarm limit.	User-selectable
T1 LOW	Measuring value of T1 channel is below lower alarm limit.	User-selectable
T2 HIGH	Measuring value of T2 channel is above upper alarm limit.	User-selectable
T2 LOW	Measuring value of T2 channel is below lower alarm limit.	User-selectable
TD HIGH	Temperature difference of T1 and T2 is above upper temperature difference limit.	User-selectable

Technical alarms:

Message	Cause	Alarm Level	What to do
TEMP SENSOR OFF	Temperature cable of TEMP channel may be disconnected from the monitor.	Low	Make sure that the cable is properly connected
T1 SENSOR OFF	Temperature cable of TEMP channel may be disconnected from the monitor.	Low	Make sure that the cable is properly connected

T2 SENSOR OFF	Temperature cable of TEMP channel 2 may be disconnected from the monitor.	Low	Make sure that the cable is properly connected.
T1 EXCEED	TEMP1 measuring value is beyond measuring range.	High	Check sensor connection and patient condition
T2 EXCEED	TEMP2 measuring value is beyond measuring range.	High	Check sensor connection and patient condition
TEMP COMM STOP	TEMP module failure or communication failure	High	Stop using measuring function of TEMP module, notify biomedical engineer or Manufacturer's service staff.

## 15.4 Care and Cleaning

### **WARNING**

Before cleaning the monitor or the probe, make sure that the equipment is switched off and disconnected from the power line.

### **Reusable TEMP Probes**

- 1 The TEMP probe should not be heated above 100 °C (212 °F). It should only be subject briefly to temperatures between 80 °C (176 °F) and 100 °C (212 °F).
- 2 The probe must not be sterilized in steam.
- 3 Only detergents containing no alcohol can be used for disinfection.
- 4 The rectal probes should be used, if possible, in conjunction with a protective rubber cover.
- 5 To clean the probe, hold the tip with one hand and with the other hand rubbing the probe down in the direction of the connector using a moist lint-free cloth.

### **NOTE:**

- 1 Wash the probe with clean water after disinfecting and sterilizing to remove any remaining solution. The probe can only be reused after being dried thoroughly.
- 2 Do not disinfect the probe by means of water boiled.
- 3 The product has not been disinfected at the factory.
- 4 Any residue should be removed from the probe before being disinfected and sterilized, and avoid contacting corrosive solvent. Dipping the cable into alcohol or



alkalescent solvent for a long time may reduce the flexibility of the scarfskin of the cable. Also, the connector should not be dipped.

- 5 After monitoring, disinfect the probe according to the instruction described in the user manual.
- 6 Disposable TEMP probe must not be re-sterilized or reused.
- 7 Cavity temperature probe is suggested to be used only inside the recta. Recommend to use the disposable cannula to prevent cross infection.
- 8 For protecting the environment, the disposable TEMP probe must be recycled or disposed of properly.
- 9 Do not force the cavity temperature probe against resistance when inserted into human body. Also it is not recommended to use it in bleeding part or cankerous part of human body.



## Chapter 16 IBP Monitoring (Optional)

### 16.1 Introduction

The monitor measures direct blood pressure (SYS, DIA and MAP) of one selected blood vessel through two channels, and displays two waveforms of measured direct blood pressure (SYS, DIA and MAP).

The available pressure labels are:

Label	Definition
ART	Arterial Blood Pressure
PA	Pulmonary Artery Pressure
CVP	Center Venous Pressure
RAP	Right Atrial Pressure
LAP	Left Atrial Pressure
ICP	Intracranial Pressure
P1-P2	Alternative non-specific pressure labels

### 16.2 Precautions during IBP Monitoring

#### **WARNING**

- 1 The operator should avoid contact with the conductive parts of the appurtenance when it is connected or applied.
- 2 When the monitor is used with HF surgical equipment, the transducer and the cables must be avoided from conductive connection to the HF equipment. This is to protect against burns to the patient.
- 3 Disposable IBP transducer or domes should not be reused.

#### **NOTE:**

Use only the pressure transducer listed in the *Chapter20 Accessories and Ordering information*.

The specified transducer is designed to have the special ability to protect against the electricity shock (especially for the leak current allowed), and it is protected against the effects of a discharge of a cardiac defibrillator. It can be used in the surgical operation. When the patient is in

the defibrillation, the waveform of the pressure maybe distorted temporarily. After the defibrillation, the monitoring will go on normally, and the operation mode and the user configuration are not affected.

---

---

### **WARNING**

- 1 Verify transducer cables fault detection before the beginning of monitoring phase. Unplug the transducer of the channel 1 from the socket, and then the screen will display the error message **IBP1 SENSOR OFF** and the audible alarm is activated. The channel 2 is the same as the above channel 1.
  - 2 If any kind of liquid, other than solution to be infused in pressure line or transducer, is splashed on the equipment or its accessories, or enters the transducer or the monitor, contact the Hospital Service Center immediately.
- 
- 

### **NOTE:**

Calibrate the instrument either whenever a new transducer is used, or as frequently as dictated by your Hospital Procedures Policy.

## **16.3 Monitoring Procedure**

Preparatory steps for IBP measurement:

1. Plug the pressure cable into the corresponding socket and switch on the monitor.
2. Flushing through the system with normal saline solution. Ensure that the system is free of air bubbles.
3. Connect the patient catheter to the pressure line, making sure that there is no air present in the catheter or pressure line.

---

---

### **WARNING**

If there are air bubbles in the pressure line or the transducer, you should flush the system with the solution to be infused.

---

---

4. Position the transducer so that it is at the same level with the patient's heart, approximately mid-axillary line.
5. Check if you have selected the correct label name. See the next section for details.
6. Zero the transducer. See the next section for details.

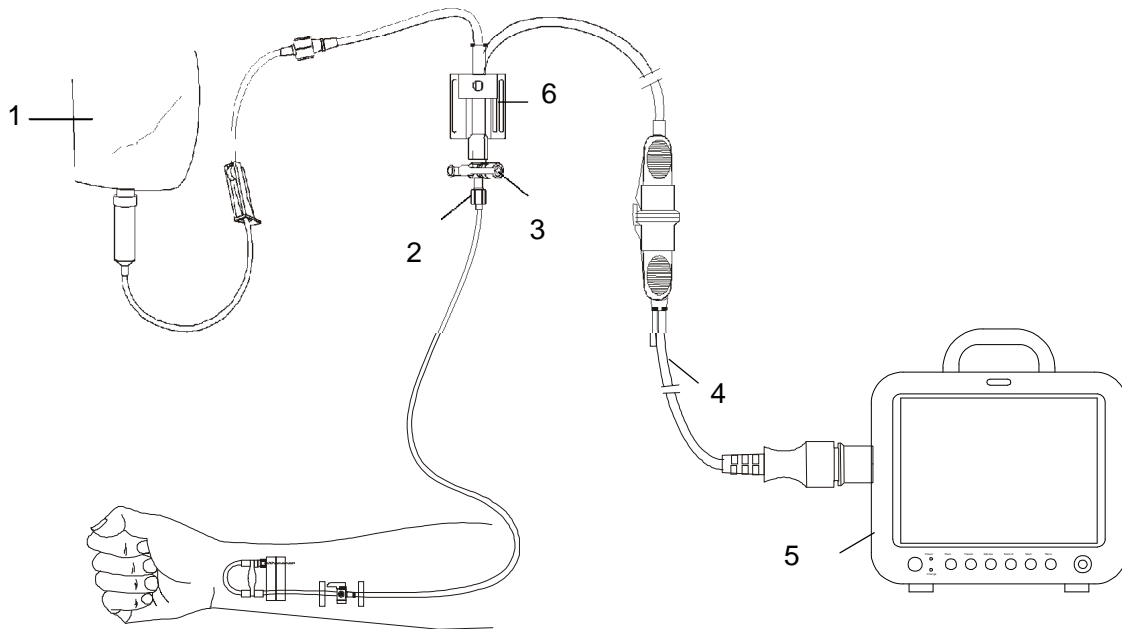

1: Normal Saline with Heparin; 2: Distal end to patient; 3: 3-way stopcock; 4: Pressure transducer interface cable; 5: Monitor; 6: Pressure transducer.

Figure 16-1 IBP Monitoring

## 16.4 IBP Menu

Pick the IBP hot key on the screen to access the **IBP SELECT** menu shown as follows:

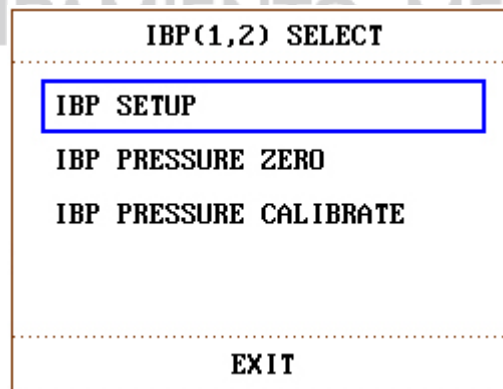



Figure 16-2 IBP SELECT Menu

Pick the **IBP SETUP** item to call up the **IBP SETUP** menu shown as follows:

IBP(1,2) SETUP			
ALM	ON	FILTER	12.5 HZ
ALM LEV	MED	CALC MODE	REALTIME
ALM REC	OFF	ALM LIMIT SETUP >>	
AMP ADJUST	MANUAL	SCALE ADJUST >>	
SWEEP	25.0	DEFAULT >>	
UNIT	mmHg		
EXIT			

Figure 16-3 IBP SETUP Menu

The items to be set up in the menu include:

- 👁️ **ALM**: select **ON** to enable alarm prompt during IBP alarm. Select **OFF** to disable audio alarm and prompt the  symbol beside **IBP** numeric.

### WARNING

In order to avoid endangering the patient's life, the user should use this function cautiously.

- 👁️ **ALM LEV**: set the alarm level. Three levels are available: **HIGH, MED, LOW**.
- 👁️ **ALM REC**: select **ON** to enable recording during the IBP alarm or to **OFF** to disable the alarm recording function.
- 👁️ **AMP ADJUST**: set to adjust waveform amplitude. Two selections are available: **MANUAL, AUTO**. Set it to **AUTO**, the pressure names of IBP become P1 and P2, and the IBP scale is adjusted by system automatically. Set it to **MANUAL**, the pressure names of IBP can choose one of **ART, PA, CVP, RAP, LAP, ICP, P1, P2** and the IBP scale is adjusted by the user via **SCALE ADJUST** item.
- 👁️ **SWEEP**: set to select the scanning speed of the IBP wave. Two selections are available: **6.25mm/s, 12.5 mm/s, 25 mm/s** or **50.0mm/s**.
- 👁️ **UNIT**: set to select the pressure unit (mmHg or kPa).
- 👁️ **FILTER**: set this item to **12.5Hz** or **40.0 Hz**.
- 👁️ **ALM LIMIT SETUP**: used to access the sub-menu of **IBP ALM LIMIT SETUP**, in which the user may set up the upper and lower alarm limits of systolic pressure, diastolic pressure and mean pressure respectively for channel 1 and channel 2.
- 👁️ **SCALE ADJUST**: used to access the sub-menu of **IBP SCALE ADJUST**, in which the user

may adjust the position of the high, reference and low scales for the two waveforms displayed on the screen.

- ⦿ **DEFAULT:** used to access the **IBP DEFAULT CONFIG** dialog box, in which the user may select whether the **FACTORY DEFAULT CONFIG** or the **USER DEFAULT CONFIG** is to be used. After selecting any of the items and exiting the dialog box, the system will pop up the dialog box asking for the user's confirmation.
- ⦿ **EXIT:** used to exit the menu and return to the main interface.

### WARNING

Before setting the alarm limits, confirm to choose the correct label.

<b>IBP ALM LIMIT SETUP</b>			
	<b>SYS</b>	<b>MAP</b>	<b>DIA</b>
<b>CH1:ART ALM HI</b>	<b>160</b>	<b>110</b>	<b>90</b>
<b>CH1:ART ALM LO</b>	<b>90</b>	<b>70</b>	<b>50</b>
<b>CH2:CVP ALM HI</b>	---	<b>10</b>	---
<b>CH2:CVP ALM LO</b>	---	<b>0</b>	---
<b>EXIT</b>			

Figure 16-4 IBP ALM LIMIT SETUP

The alarm occurs when the value exceeds the set limits.

Default IBP alarm limits:

P1:

SYS    90 mmHg ~ 160 mmHg  
 DIA    50 mmHg ~ 90 mmHg  
 MAP    70 mmHg ~ 110 mmHg

P2:

SY      90 mmHg ~ 160 mmHg  
 DIA    50 mmHg ~ 90 mmHg  
 MAP    70 mmHg ~ 110 mmHg

ART:

SYS    90 mmHg ~ 160 mmHg  
 DIA    50 mmHg ~ 90 mmHg  
 MAP    70 mmHg ~ 110 mmHg

PA:

SYS    10 mmHg ~ 35 mmHg  
 DIA    0 mmHg ~ 16 mmHg

MAP 0 mmHg ~ 20 mmHg  
 CVP, RAP, LAP, ICP:  
 MAP 0 mmHg ~ 10 mmHg

The adjusting range of IBP alarm limits:

Pressure Label	Max. Alarm High (mmHg)	Min. Alarm Low (mmHg)	Step (mmHg)
ART	300	0	1
PA	120	-6	1
CVP	40	-10	1
RAP	40	-10	1
LAP	40	-10	1
ICP	40	-10	1
P1	300	-10	1
P2	300	-10	1

### IBP Transducer Zero

Press the **IBP PRESSURE ZERO** button on the **IBP SELECT** menu to call up **IBP PRESSURE ZERO** menu as shown below:

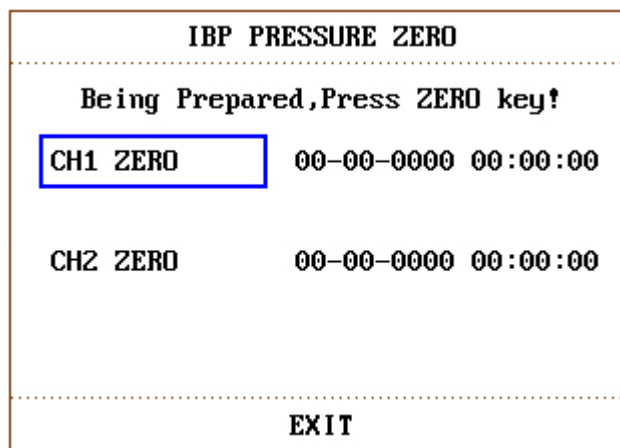

Figure 16-5 IBP PRESSURE ZERO

### NOTE:

It is the responsibility of the user to ensure that a zero procedure has recently been done on the transducer: otherwise there will be no recent, valid zero value for the instrument to use, which may result in inaccurate measurement results.

## Zero Calibration of Transducer

Select CH1, and then IBP1 returns to zero. Select CH2, and then IBP2 returns to zero.

### **CAUTION**

- 1 Turn off the patient stopcock before you start the zero procedure.
- 2 The transducer must be vented to atmospheric pressure before the zero procedure.
- 3 The transducer should be placed at the same height level with the heart, approximately mid-axillary line.
- 4 Zero procedure should be performed before the monitoring starts, and at least once a day after each disconnect-and-connect of the cable.

The prompt information related to zero calibration, take CH1 for example.

① **“CH1 ZERO SUCCESS!”**

Indicate that zero calibration is over , so you can turn off the stopcock that was open to atmospheric pressure, and turn on the patient stopcock.

① **“CH1 ZERO FAIL!”**

Make sure that the transducer is not attached to the patient.

① **“CH1 SENSOR OFF, FAIL!”**

Make sure that transducer is not off, and then proceed zeroing.

① **“IN DEMO, FAIL!”**

Make sure that the monitor is not in **DEMO** mode. Contact service technician if necessary.

① **“PRESSURE OVER RANGE, FAIL!”**

Make sure that the stopcock is vented to atmosphere. If the problem persists, please contact service technician.

## IBP Calibration

Press the **IBP PRESSURE CALIBRATE** button on the **IBP (1, 2) SELECT** menu to call up the **IBP PRESSURE CALIBRATE** menu as shown below:

IBP PRESSURE CALIBRATE			
CH1 CAL VALUE	26.7	CALIBRATE	
0 ( 0 )	00-00-0000	00:00:00	
CH2 CAL VALUE	26.7	CALIBRATE	
0 ( 0 )	00-00-0000	00:00:00	
EXIT			

Figure 16-6 IBP Calibration Menu



**Calibrate the transducer:**

Turn the knob to select the item **CH1 CAL VALUE**, press and turn the knob to select the pressure value to be calibrated for channel 1. Then turn the knob to select **CALIBRATE** in the menu to start calibrating channel 1.

Turn the knob to select the item **CH2 CAL VALUE**, press and turn the knob to select the pressure value to be calibrated for channel 2. Then turn the knob to select **CALIBRATE** in the menu to start calibrating channel 2.

- 👁 The pressure calibration of the portable patient monitor

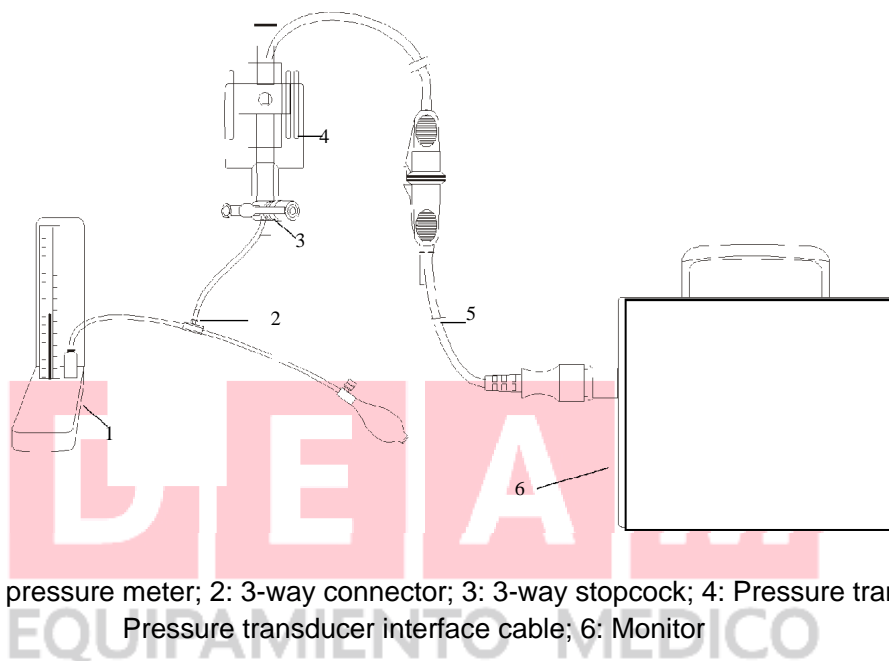

Figure 16-7 IBP Calibration

---



---

**CAUTION**

- 1 Mercury calibration should be performed by the biomedical engineering department either whenever a new transducer is used, or as frequently as dictated by your Hospital Procedures Policy.
  - 2 The purpose of the calibration is to ensure that the system gives you accurate measurements.
  - 3 Before starting a mercury calibration, a zero procedure must be performed.
  - 4 If you need to perform this procedure yourself you will need the following equipment: Standard sphygmomanometer, 3-way stopcock and Tubing (approximately 25 cm long).
- 
- 

**WARNING**

It is forbidden to perform this procedure while patient is being monitored.

---



---

The Calibration Procedure: (See Figure 16-7)

1. Close the stopcock that was open to atmospheric pressure for the zero calibration.
2. Attach the tubing to the sphygmomanometer.
3. Ensure that connection that would lead to patient is off.
4. Connect the 3-way connector to the 3-way stopcock that is not connected to the patient catheter.
5. Open the port of the 3-way stopcock to the sphygmomanometer.
6. Select the channel to be calibrated in the menu and select the pressure value to which the IBP is to be adjusted.
7. Inflate to make the mercury bar rise to the setup pressure value.
8. Adjust repeatedly until the value in the menu is equal to the pressure value shown by the mercury calibration.
9. Press the Start button, the device will begin calibrating.
10. Wait for the calibrated result. You should take corresponding measures based on the prompt information.
11. After calibration, disassemble the blood pressure tubing and the attached 3-way valve.

The prompt information related to calibration, take CH1 for example.

👁️ “CH1 CAL SUCCESS!”

Indicate that CH1 works normally, you can use CH1 to monitor the patient.

👁️ “CH1 CAL FAIL!”

Make sure that pressure value shown by hydrargyrum pressure meter is change- less.

👁️ “CH1 SENSOR OFF, FAIL!”

Make sure that sensor is not off, then start the calibration.

👁️ “IN DEMO, FAIL!”

Make sure that the monitor is not in **DEMO** mode. Contact service technician if necessary.

👁️ “PRESSURE OVER RANGE, FAIL!”

Make sure that you have selected transducer value in **IBP CAL**, then start the calibration.

### IBP SCALE ADJUST Submenu

IBP SCALE ADJUST			
	HI	LO	VAL
CH1:ART	20.0	0.0	10.0
CH2:CVP	5.3	0.0	2.7
EXIT			

Figure 16-8 IBP SCALE ADJUST Menu

The waveform and corresponding scale appears in the IBP Waveform Area with 3 dotted lines representing High Limit Scale, Reference Scale, and Low Limit Scale from the top to the bottom. Values of the three scales can be user-set according to the instruction given below.

- 👁️ **IBP label:** selectable from **ART, PA, CVP, RAP, LAP, ICP, P1, P2;**
- 👁️ **HI:** IBP value of High Limit scale, its range is the measuring range of the current pressure.

**NOTE:**

The HI value must be higher than the LO value.

- 👁️ **LO:** IBP value of Low Limit scale, its range is the measuring range of the current pressure.

**NOTE:**

The LO value must be lower than the HI value.

- 👁️ **VAL:** IBP value of Reference scale (between HI and LO).

**NOTE:**

When change HI scale, Low scale or Reference scale of IBP waveform and the corresponding IBP waveforms are displayed under the menu window, the waveform will come penetratingly through the menu window for observing.

## 16.5 Alarm Information

Tables below describe the possible physiological alarms, technical alarms occurring during IBP measurement.

Physiological alarms:

Message	Cause	Alarm Level
IS1 HIGH	SYS measuring value of channel 1 is above upper alarm limit.	User-selectable
IS1 LOW	SYS measuring value of channel 1 is below lower alarm limit.	User-selectable
ID1 HIGH	DIA measuring value of channel 1 is above upper alarm limit.	User-selectable
ID1 LOW	DIA measuring value of channel 1 is below lower alarm limit.	User-selectable
IM1 HIGH	MAP measuring value of channel 1 is above upper alarm limit.	User-selectable
IM1 LOW	MAP measuring value of channel 1 is below lower alarm limit.	User-selectable
IS2 HIGH	SYS measuring value of channel 2 is above upper alarm limit.	User-selectable

IS2 LOW	SYS measuring value of channel 2 is below lower alarm limit.	User-selectable
ID2 HIGH	DIA measuring value of channel 2 is above upper alarm limit.	User-selectable
ID2 LOW	DIA measuring value of channel 2 is below lower alarm limit.	User-selectable
IM2 HIGH	MAP measuring value of channel 2 is above upper alarm limit.	User-selectable
IM2 LOW	MAP measuring value of channel 2 is below lower alarm limit.	User-selectable

Technical alarms:

Message	Cause	Alarm Level	What to do
IBP1 SENSOR OFF	IBP cable of channel 1 falls off from monitor.	Low	Make sure that cable is properly connected.
IBP2 SENSOR OFF	IBP cable of channel 2 falls off from monitor.	Low	
IBP COMM STOP	IBP module failure or communication failure	High	Stop using measuring function of IBP module, notify biomedical engineer or Manufacturer's service staff.

## 16.6 Maintenance and Cleaning

### **WARNING**

Before cleaning the monitor or the transducer, make sure that the equipment is switched off and disconnected from the power line.

#### **Cleaning of IBP Transducer (Reusable)**

After the IBP monitoring operation is completed, remove the tubing and the dome from the transducer and wipe the transducer diaphragm with water. Clean the transducer and cable with soap or cleaning agents listed below:

- Cetylcide
- Wavicide-01
- Wescodyne
- Cidex

Lysol  
Vesphene

Do not immerse the connector in any liquid. After cleaning, dry the transducer thoroughly before storing. Slight discoloration or temporary increase of surface stickiness of the cable should not be considered abnormal. If adhesive tape residue must be removed from the transducer cable, double seal tape remover is effective and will cause a minimum of damage to the cable if used sparingly. Acetone, Alcohol, Ammonia and Chloroform, or other strong solvents are not recommended because over time the vinyl cabling will be damaged by these agents.

**NOTE:**

- 1 The disposable transducers or domes must not be re-sterilized or re-used.
- 2 For protecting environment, the disposable transducers or domes must be recycled or disposed of properly.

**Sterilization****👁** Liquid Chemical Sterilization

Remove obvious contamination by using the cleaning procedure described previously. Select a sterilant that your hospital or institution has found to be effective for liquid chemical sterilization of operating room equipment. Buffered glutaraldehyde (e.g. Cidex or Hospisept) has been found to be effective. Do not use quaternary cationic detergents such as zephiran chloride. If the whole unit is to be sterilized, immerse the transducer but not the electrical connector into the sterilant for the recommended sterilizing period. Be sure that the dome is removed. Then rinse all transducer parts except the electrical connector with sterilized water or saline. The transducer must be thoroughly dried before storing.

**👁** Gas Sterilization

For more complete asepsis, use gas sterilization.

Remove obvious contamination by using the cleaning procedure described previously. To inhibit the formation of ethylene glycol when ethylene oxide gas is used as the disinfectant, the transducer should be completely dry.

Follow the operating instructions provided by the manufacturer of the gas disinfectant.

---

**WARNING**

---

The sterilizing temperature must not exceed 70°C (158°F). Plastics in the pressure transducer may deform or melt above this temperature.

---

## Chapter 17 CO<sub>2</sub> Measuring (Optional)

### 17.1 General

This chapter offers some relevant data concerning CO<sub>2</sub> monitoring.

The monitor provides the SideStream and MainStream methods for CO<sub>2</sub> monitoring. KM7002 module is used for SideStream measuring. , Capnostat 5 CO<sub>2</sub> module (C5) is used for MainStream measuring.

SideStream measurement takes a sample of the respiratory gas with a constant sample flow from the patient's airway and analyzes it with a remote CO<sub>2</sub> sensor. You can measure SideStream CO<sub>2</sub> using the monitor's built-in CO<sub>2</sub> measurement.

MainStream measurement uses a CO<sub>2</sub> sensor attached to an airway adapter directly inserted into the patient's breathing system.

The CO<sub>2</sub> module can be applied in an operation room, monitor units etc. It can measure the CO<sub>2</sub> partial pressure or concentration of patient Air Way, obtain End tidal CO<sub>2</sub> (EtCO<sub>2</sub>), Fraction of inspired CO<sub>2</sub> (FiCO<sub>2</sub>), and Air Way Respiration Rate (AwRR), and display CO<sub>2</sub> concentration waveforms. The parameter symbols displayed on the screen are defined as follows:

CO <sub>2</sub> :	EtCO <sub>2</sub>
FI:	FiCO <sub>2</sub>
AWRR:	Air Way Respiration (AwRR) (Resp. times/min)

#### **WARNING**

- 1 CO<sub>2</sub> module shall be avoided from crash and vibration.
- 2 Do not use the device in the environment with flammable anesthetic gas. For example, do not use it in the environment where flammable anesthetic is mixed with air, oxygen or nitrous oxide. The device should be operated by trained and qualified personnel who are familiar with the manual.
- 3 Nitrous oxide, elevated levels of oxygen, helium, xenon, halogenated hydrocarbons, and barometric pressure can influence the CO<sub>2</sub> measurement.
- 4 Follow precautions for electrostatic discharge (ESD) and electromagnetic interference (EMI) to and from other equipment.
- 5 Do not place the sensor cables or tubing in any manner that may cause entanglement or strangulation.
- 6 Do not store the CO<sub>2</sub> Module at temperatures less than -40° F (-40° C) or greater than 158° F (70° C).
- 7 Do not operate the CO<sub>2</sub> Module at temperatures less than 32° F (0° C) or greater than 104° F (40° C).
- 8 In the presence of electromagnetic devices (i.e., electrocautery), patient monitoring may be interrupted due to electromagnetic interference. Electromagnetic fields up to 20V/m will not adversely affect module performance.

**NOTE:**

After the Low battery alarm is activated, please do not start the CO<sub>2</sub> measurement, or the monitor may be turned off for the low capacity of battery.

## 17.2 Monitoring Procedure

The principle of CO<sub>2</sub> measurement is primarily based on the fact that CO<sub>2</sub> molecule can absorb 4.3μm infrared ray. Absorption intensity is proportional to CO<sub>2</sub> concentration of patient sample, the CO<sub>2</sub> concentration will compute according to the detecting CO<sub>2</sub> absorption intensity of patient sample. The relation between partial pressure and percentage of CO<sub>2</sub> concentration is given below:

$$P \text{ (mmHg)} = \text{Percentage (\%)} \times P_{\text{amp}} \text{ (Ambient Pressure)}$$

### KM7002 CO<sub>2</sub> Module Setup

1. Fix the KM7002 CO<sub>2</sub> module onto the bracket of the monitor, and connect the water trap if you use KM7002 CO<sub>2</sub> module. Add a sampling cannula to further remove the influence of water vapor.
2. Power on the system, start up **CO<sub>2</sub> SETUP** menu, and change **WORK MODE** from **STANDBY** to **MEASURE** (refer to **CO<sub>2</sub> SETUP** for details).
3. After CO<sub>2</sub> monitoring, please set the CO<sub>2</sub> module to **STANDBY** mode duly.

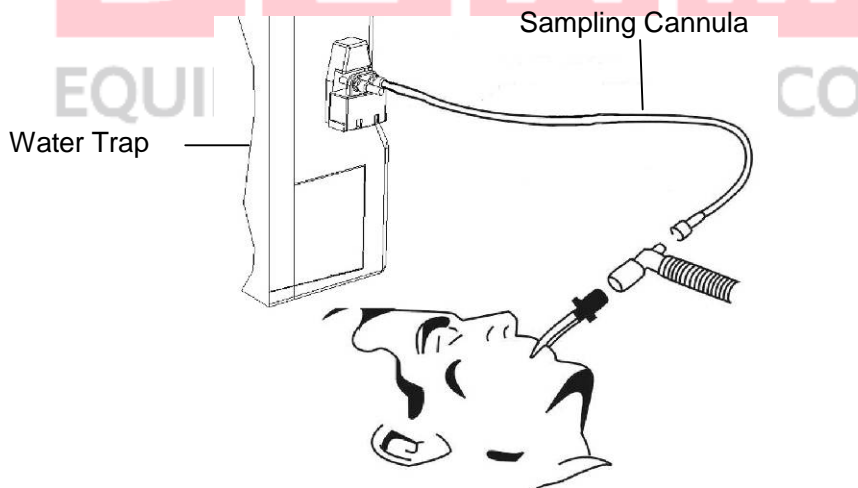

Figure 17-1 KM7002 CO<sub>2</sub> Module Connection



Figure 17-2 Water Trap for KM7002 CO<sub>2</sub>module

**NOTE:**

- 1 Do not use the accessories which are damaged or the packaging is damaged, and please return them to the vendor.
- 2 The sampling cannula is disposable that can not be reused by different patients.
- 3 For using KM7002 module, the monitor will be damaged if any pipeline is disconnected, or the air tube, the air inlet, the air outlet are plugged by water or other materials.
- 4 Please replace the water trap before it is completely filled.
- 5 The accuracy of the CO<sub>2</sub> measurement will be affected by the following facts: the air way is highly obstructed or air leaks, the leakage of air way connection, quick variation of environment temperature.
- 6 Do not start up the CO<sub>2</sub> module if the water trap was not connected. This is to avoid damage to the machine after impurities enter the pipeline.

---

**WARNING**

When KM7002 module is adopted, the water of the water trap should not reach the bottom of drainpipe, or the monitor will be damaged.

---

## C5 CO<sub>2</sub> Module Setup

**NOTE:**

You must perform a zero calibration as described in this procedure each time you use a new airway adapter.



Figure 17-3 C5 CO<sub>2</sub> module

- 1 Attach the sensor connector to the CO<sub>2</sub> connector on the monitor.
- 2 Wait two minutes, allowing the sensor to reach its operating temperature and a stable thermal condition.
- 3 Choose the appropriate airway adapter and connect it to the sensor head. The airway adapter clicks into place when seated correctly.

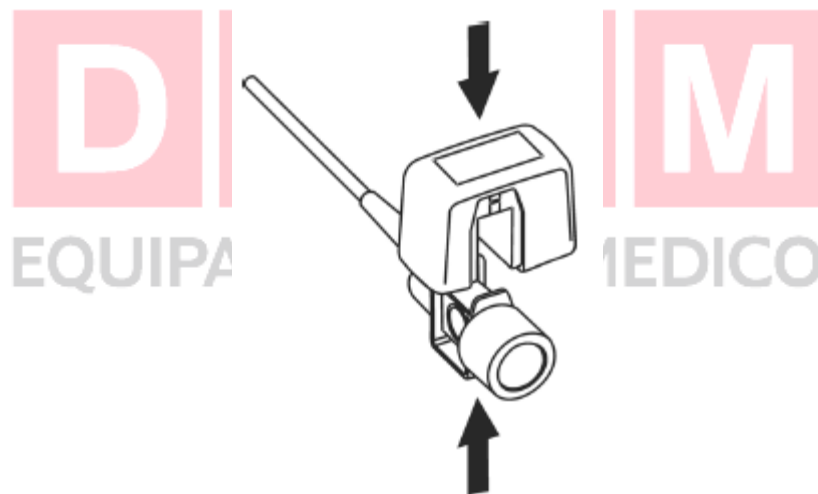

Figure 17-4 Connecting sensor

- 4 To zero the sensor:
  - Expose the sensor to room air and keep it away from all sources of CO<sub>2</sub> including the ventilator, the patient's breath and your own.
  - Start up **CO<sub>2</sub> SETUP** menu, and change **WORK MODE** from **STANDBY** to **MEASURE**
  - In the **CO<sub>2</sub> SETUP** menu, select **ZERO CAL.**
  - The messages indicate: "**zero started**", "**zero successful**". After the zero calibration is finished, the user can start CO<sub>2</sub> Monitoring.
- 5 Install the airway adapter at the proximal end of the circuit between the elbow and the ventilator Y-section.

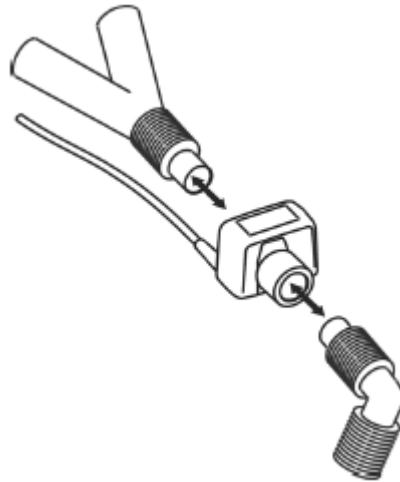

Figure 17-5 Connecting airway adapter

---

**WARNING**

- 1 The CO<sub>2</sub> sensor should be contrasted with calibration gas every 12 months.
- 2 Accuracy is affected by temperature and barometric pressure.
- 3 It is forbidden to insert or draw out the module when the monitor is working, for it can cause instability of the system. If you do it unconsciously, please turn off the module in menu immediately. The module enters **STANDBY** mode if you reconnect it to monitor which is powered on. If the readings are inaccurate, you should do calibration.

---

**NOTE :**

- 1 If the cannula is off during measurement, please perform a zero calibration after connecting it before restarting measurement.
- 2 Replace the airway adapter if excessive moisture or secretions are observed in the tubing or if the CO<sub>2</sub> waveform changes unexpectedly without a change in patient status.
- 3 To avoid infection, only use sterilized, disinfected or disposable airway adapters.
- 4 Inspect the airway adapters prior to use. Do not use if airway adapter appears damaged or broken. Periodically check the flow sensor and tubing in case of excessive moisture or secretion buildup.
- 5 Always connect the airway adapter to the sensor before inserting the airway adapter into the breathing circuit. In reverse, always remove the airway adapter from the breathing circuit before removing the sensor.

## KM7002 Module Setup

Prior to using this module, please peruse the following information:

---

### **WARNING**

- 1 The module is for offering data of exhalant CO<sub>2</sub> density and respiration rate, which only for the purpose of assisting in diagnoses. Diagnoses should be made based on clinical symptoms.
  - 2 Do not reuse the disposable sampling cannula in case of cross infection.
- 

---

### **CAUTION**

- 1 This module is supposed to be used by professionally trained personnel or in professional medical institutions. Operators should be familiar with the manual prior to using this module.
  - 2 Please notice the level of the serial interface while communicating with the mainframe. Make sure your requirement in your order is consistent with your needs in terms of level. (TTL or 232. If TTL is your choice, please advice the level of 5V or 3.3V).
  - 3 It is suggested that one water tray shall not be used by different patients in case of cross inflection.
  - 4 Replace the water tray before it is completely filled in case of damage in the module.
  - 5 Make sure the sampling cannula is unimpeded and works well. If the sampling pump is chronically overloaded due to the twisted sampling cannula and so forth, it will affect the service life of the pump as well as the module.
  - 6 Do not measure the exhalant gas from the patient with this module before well connecting the water tray. The exhalant humidity may cause discrepancy in measurements, and the service life of the module may also be affected.
  - 7 Readings may deviate if the device has not reached its operating temperature after it is switched on.
- 

### **NOTE:**

- 1 Using the monitor together with the strong electromagnetic sources, such as electrosurgery device, MRI device, etc., may lead to bad consequences.
- 2 Using the monitor in front of the CT device may lead to bad consequences.
- 3 Only use the sampling cannulas provided by the manufacturer. Using sampling cannulas provided by other manufacturers may cause inaccuracy in data.
- 4 Using the module under the dramatically altering temperature may cause inaccuracy in data. It is suggested that the module should be used under stable temperature.
- 5 Administration of the anesthetic gas may have minute influence on the measurements. Please perform a calibration according to the protocol or contact with

the manufacturer.

- 6 Factors such as occlusion caused by twisted or stemmed sampling cannulas, serious occlusion of flitters or water trays and so forth may lead to inaccuracy of the measurements and shorten the service life of the module.
- 7 Over high or over low CO<sub>2</sub> density due to serious respiratory failure, such as a EtCO<sub>2</sub> density of lower than 1% or higher than 10%, may cause discrepancy of measurements.
- 8 Air leaks of the cannula caused by any factor will make a great impact on the accuracy of the measurement and the display of waveforms.

## 17.3 CO<sub>2</sub> SETUP

### Parameter Setup and Adjustment

Turn the knob to select and press CO<sub>2</sub> hot key on the screen to activate **CO<sub>2</sub> SETUP** menu as shown below:

CO <sub>2</sub> SETUP			
ALM	ON	WORK MODE	STANDBY
ALM LEV	MED	APNEA ALM	20S
ALM REC	OFF	SWEEP	12.5
CO <sub>2</sub> ALM HI	50	UNIT	mmHg
CO <sub>2</sub> ALM LO	15	ZERO CAL	
INS ALM HI	4	DEFAULT >>	
AWRR ALM HI	30	OTHER SETUP >>	
AWRR ALM LO	8		
EXIT			

Figure 17-6 CO<sub>2</sub> Setup

The items to be set up in the menu include:

- 👁️ **ALM**: Select **ON** to enable and store alarm prompt when CO<sub>2</sub> parameters have alarms.

Select **OFF** to disable alarm and display  beside CO<sub>2</sub>. The default is **ON**.

#### WARNING

In order to avoid endangering the patient's life, the user should use this function cautiously.

- 👁️ **ALM LEV**: Select from **HIGH**, **MED** and **LOW**. Level **HIGH** represents the most serious

alarm, followed by Level **MED** and Level **LOW** with a decrease of seriousness. Change in **ALM LEV** can only affect the physiological alarm levels of CO<sub>2</sub> parameters including EtCO<sub>2</sub> upper limit, EtCO<sub>2</sub> lower limit, InsCO<sub>2</sub> upper limit, AwRR upper limit and AwRR lower limit. The default alarm level is **MED**.

- ① **ALM REC**: Select **ON** to generate output from the recorder ever since CO<sub>2</sub> parameter alarm occurs. The default value is **OFF**.
- ① **CO<sub>2</sub> ALM HI**: to adjust the upper alarm limit of EtCO<sub>2</sub>. If the measuring value is larger than CO<sub>2</sub> upper alarm limit, **CO<sub>2</sub> HIGH** appears on the screen. After the measuring value returns to the normal one, the information disappears.
- ① **CO<sub>2</sub> ALM LO**: to adjust the lower alarm limit of EtCO<sub>2</sub>. If the measuring value is smaller than CO<sub>2</sub> lower alarm limit, **CO<sub>2</sub> LOW** appears on the screen. After the measuring value returns to the normal one, the information disappears.
- ① **FI ALM HI**: to adjust the upper alarm limit of FiCO<sub>2</sub>. If the measuring value is larger than FiCO<sub>2</sub> upper alarm limit, **FI HIGH** appears on the screen. After the measuring value returns to the normal one, the information disappears.
- ① **AWRR ALM HI**: to adjust the upper alarm limit of AwRR. If the measuring value is larger than the upper alarm limit of AwRR, **AWRR HIGH** appears on the screen. After the measuring value returns to the normal one, the information disappears.
- ① **AWRR ALM LO**: to adjust the lower alarm limit of AwRR. If the measuring value is smaller than the lower alarm limit of AwRR, **AWRR LOW** appears on the screen. After the measuring value returns to the normal one, the information disappears.
- ① **WORK MODE**: to change the work mode of CO<sub>2</sub> with between **MEASURE** and **STANDBY**. The default is **STANDBY**. When it is required to monitor CO<sub>2</sub>, you should select **MEASURE**. In **STANDBY** mode, the air pump in SideStream module is disabled, which decreases the power consumption and extends the lifecycle of IR source and the whole CO<sub>2</sub> module.

**NOTE:**

When the CO<sub>2</sub> monitoring function is not in use, please set the **WORK MODE** to **STANDBY**.

- ① **UNIT**: to change the display units of CO<sub>2</sub> and FiCO<sub>2</sub> parameters. **mmHg** and **kPa** are available for selection.
- ① **APNEA ALM**: After selecting the alarm time for **APNEA** alarm (having 7 levels, which are **10S, 15S, 20S, 25S, 30S, 35S** and **40S**), the **CO<sub>2</sub> APNEA** information will appear on the screen after the corresponding selected time. The alarm level is **HIGH**.
- ① **SWEEP**: to adjust the display rate of CO<sub>2</sub> waveforms with **6.25mm/s, 12.5mm/s, 25.0mm/s** or **50.0mm/s** selectable.
- ① **Exit**: to exit **CO<sub>2</sub> SETUP** menu.

**NOTE:**

- 1 **APNEA ALM** cannot be canceled.
- 2 When various alarms occur simultaneously, the alarm information of the highest level will be displayed on the screen.

👁 **OTHER SETUP:** pick this item in the menu to call up **CO<sub>2</sub> SETUP** menu as follows.

CO <sub>2</sub> SETUP			
WAVE SCALE	LOW	WATERVAPOR	OFF
BARO PRESS	760mmHg	BTPS	OFF
O <sub>2</sub> COMPENS	16 %	PUMP RATE	100ml/min
ANE AGENT	0.0%	COMPENSATE	GENERAL
BALAN GAS	ROOM AIR		
EXIT			

Figure 17-7 CO<sub>2</sub> Other Setup

**NOTE:**

When using KM7002 module, **BARO PRESS**, **O<sub>2</sub> COMPENS**, **ANE AGENT** and **BALAN GAS** items are unavailable.

Now we introduce you to the functions of each item in **CO<sub>2</sub> SETUP** submenu.

**WAVE SCALE:** to adjust full scale size of CO<sub>2</sub> waveform display area with **LOW** or **HIGH** selectable. The default value is **LOW**.

**BARO PRESS:** to set the barometric pressure value. For gaining accurate readings, you should set this barometric pressure correctly.

<b>Altitude</b>	<b>Barometric Pressure</b>
<b>Meters</b>	<b>mmHg</b>
Sea Level	760
152.4	745
228.6	738
304.8	731
457.2	717
609.6	704
762	690
914.9	677
1066.8	665
1219.2	652
1371.6	640
1524	628
1676.4	616
1828.8	604
1981.2	593
2133.6	581
2286	570
2438.4	560
2590.8	549
2743.2	539
3048	518
3200.4	509
3352.8	499
3505.2	490
3657.6	480
3810	471
3962.4	462
4114.8	454
4267.2	445
4419.6	437
4572	428
4724.4	420
4876.8	412
5029.2	405
5120.6	400

Table 17-1

**O<sub>2</sub> COMPENS:** to adjust the O<sub>2</sub> compensation concentration as per the selection of the user. Input the proper O<sub>2</sub> compensate value according to the O<sub>2</sub> concentration of the inhaled gas.

**ANE AGENT:** to adjust the anesthetic compensation concentration as per the selection of the user. The concentration ranges from 0~2.0%. Input the proper concentration value according to the anesthetic gas concentration of the inhaled gas.

**BALAN GAS:** to balance the gas compensating operations. Select different compensating types for balancing gas. The compensation types are **ROOM AIR**, **N<sub>2</sub>O** and **HELIUM**.

**WATERVAPOR:** determine whether to make watervapor compensate.

Water vapor compensation accounts for the effect of water vapor on the CO<sub>2</sub> IR (Infra-Red) absorption characteristics. The user may disable this compensation in certain situations. During normal operation, CO<sub>2</sub> measurements are adjusted mathematically to compensate for this effect.

The host may choose to disable this compensation when performing dry gas measurements in which the gas does not contain water vapor.

The water vapor compensation is **ON** by default and may be enabled or disabled via a host system command.

**BTPS:** The user may want to choose whether to correct values for gas that is at body temperature, ambient pressure and is saturated with water vapor (BTPS) or the ambient temperature and pressure and is dry (ATPD). BTPS compensation (Body Temperature and Pressure, Saturated) is a user-selectable compensation that accounts for the differences between the airway sample and “deep lung” CO<sub>2</sub>. Since the intent is to report “deep lung” CO<sub>2</sub>, where the sample is at 37 °C and fully saturated, BTPS compensates for the variance of water vapor content due to temperature. The BTPS compensation of CO<sub>2</sub> module is on by default.

**PUMP RATE:** to adjust the pump rate of the air pump of CO<sub>2</sub> module with **100ml/min**, **150ml/min**, or **200ml/min** selectable. The default value is **100ml/min**. **PUMP RATE** is only available in KM7002 module.

**COMPENSATE:** to perform different compensate operations as per the selection of the user. The selections are **GENERAL**, **O<sub>2</sub>**, **N<sub>2</sub>O** and **ALL**. The work conditions for calculating compensation are shown in the following table. Here is the operation method. First, select the gas compensation to be used, including general compensation, O<sub>2</sub> compensate, N<sub>2</sub>O compensate and ALL compensate. Then, determine whether to make VA compensate and BTPS compensate.

Work Conditions for CO<sub>2</sub> Calculation compensation:

Calculation Compensate Method	O <sub>2</sub> Modification	N <sub>2</sub> O Modification	Work Conditions
General	OFF	OFF	O <sub>2</sub> 20%, no N <sub>2</sub> O
O <sub>2</sub>	ON	OFF	O <sub>2</sub> 80%, no N <sub>2</sub> O
ALL	OFF	ON	O <sub>2</sub> 60%, N <sub>2</sub> O 40%
N <sub>2</sub> O	ON	ON	O <sub>2</sub> 40%, N <sub>2</sub> O 60%

**ZERO CAL:** used to perform CO<sub>2</sub> model zero calibration.

When a dramatic change in CO<sub>2</sub> measurement or the accuracy of reading is suspected by the



clinician, please select “**ZERO CAL**” item, then the system will automatically inhale clean CO<sub>2</sub>-free room air to the air inlet of CO<sub>2</sub> module beside the monitor, and start zero calibration.

**NOTE:**

- 1 If Compensate item is not correctly set as per the operation conditions, the result will be far from the actual value, thus leading to severe misdiagnosis.
- 2 The default value of Water Vapor Compensate is on. Turn it off when measuring dry gas, such as when performing regular maintenance or measurement validation by using dry calibrated gas.
- 3 The default of BTPS is on. Turn it on when measuring the VA saturated “damp” gas at the body temperature and ambient pressure and turn it off when measuring the “dry” gas at the ambient temperature and pressure.
- 4 Operate by strictly observing the Compensate operation method.
- 5 The standard barometric pressure is 760mmHg, O<sub>2</sub> concentration is about 16%. The **BARO PRESS** should be set according to the local altitude, refer to table 17-1 for details.
- 6 If the **ANE AGENT, O<sub>2</sub> COMPENS, BALAN GAS** are set incorrectly, the measure readings will deviate from the reality, leads to misdiagnosis.
- 7 The **ZERO CAL** needs about 20 seconds. During this period, you’d better not do other operations, such as respiration measuring. Or the zero calibration will fail, and you should do calibration operation again.

**DEFAULT >>:** pick this item to access the **CO<sub>2</sub> DEFAULT CONFIG** dialog box, in which the user may select whether the **FACTORY DEFAULT CONFIG** or the **USER DEFAULT CONFIG** is to be used. After selecting any of the items and exiting the dialog box, the system will pop up the dialog box asking for the user’s confirmation.

EtCO<sub>2</sub> upper alarm limit: when the parameter value exceeds this limit, there will be an alarm for exceeding the upper limit.

Default:	
Adult:	50 mmHg
Pediatric:	50 mmHg
Neonatal:	45 mmHg

EtCO<sub>2</sub> lower alarm limit: when parameter value is smaller than the lower limit, there will be alarm.

Default:	
Adult:	15 mmHg
Pediatric:	20 mmHg
Neonatal:	30 mmHg

FiCO<sub>2</sub> upper alarm limit: when parameter value exceeds this limit, there will be alarm for exceeding upper limit.

Default:	
Adult:	4 mmHg
Pediatric:	4 mmHg

Neonatal: 4 mmHg

AwRR upper alarm limit: when parameter value exceeds this limit, there will be alarm for exceeding upper limit.

Default:

Adult: 30 rpm

Pediatric: 30 rpm

Neonatal: 100 rpm

AwRR lower alarm limit: when parameter value is smaller than the limit, there will be alarm for exceeding lower limit.

Default:

Adult: 8 rpm

Pediatric: 8 rpm

Neonatal: 30 rpm

APNEA Time: options are 10S to 40S (C5); 20S~40S (KM7002)

Default: 20S

Work Mode: Standby, Measurement

Default: Standby

BALAN GAS: ROOM AIR/ N<sub>2</sub>O /HELIUM

Default: ROOM AIR.

O<sub>2</sub> COMPENSATE: 0 ~ 100%

Default: 16 %

ANE COMPENS: 0 ~ 2.0%

Default: 0.0%

BARO PRESS: 400 mmHg - 850mmHg

Default: 760mmHg.

Compensate: General/O<sub>2</sub>/N<sub>2</sub>O/ALL

Default Methods: General

Pump Rate: 100 ml/min - 200 ml/min

Default: 100 ml/min

Unit: mmHg/kPa/%

Default: mmHg

Waveform Sweep: 50.0/ 25.0/ 12.5/ 6.25 (mm/s)

Default: 12.5 mm/s

Waveform Scale: LOW/HIGH

Default: LOW

## 17.4 Alarm Information and Prompt

Among physiological alarms, those belonging to the type that the parameter has exceeded the limits may activate the recorder to automatically output the parameters and related measured waveforms when the alarms occur on condition that the alarm record switch in the related menu is **ON**.

Tables below describe the possible physiological alarms, technical alarms and prompt messages occurring during CO<sub>2</sub> measurement.

Physiological alarms:

Message	Cause	Alarm Level
CO <sub>2</sub> HIGH	EtCO <sub>2</sub> measuring value is above upper alarm limit.	User-selectable
CO <sub>2</sub> LOW	EtCO <sub>2</sub> measuring value is below lower alarm limit.	User-selectable
FI HIGH	FiCO <sub>2</sub> measuring value is above alarm limits.	User-selectable
AWRR HIGH	AwRR measuring value is above upper alarm limit.	User-selectable
AWRR LOW	AwRR measuring value is below lower alarm limit.	User-selectable
CO <sub>2</sub> APNEA	In a specific time interval, no RESP can be detected using CO <sub>2</sub> module.	High

Technical alarms:

Message	Cause	Alarm Level	What to do
CO <sub>2</sub> SENSOR OFF	CO <sub>2</sub> sensor falls off	Low	Well connect the sensor
CO <sub>2</sub> NO WATERTRAP	Water trap of SideStream falls off	Low	Connect the water trap well
CO <sub>2</sub> WATERTRAP OCCLUDE	Water trap of SideStream is occluded	Low	Make sure the gas exhaust works well
CO <sub>2</sub> SENSOR FAULT	CO <sub>2</sub> module failure	High	Stop using measuring function of CO <sub>2</sub> module, notify biomedical engineer.
CO <sub>2</sub> SENSOR TEMP HIGH			
CO <sub>2</sub> SENSOR TEMP LOW			

CO <sub>2</sub> INIT ERR	CO <sub>2</sub> module has not been connected well or has a fault	High	Stop using measuring function of CO <sub>2</sub> module, notify biomedical engineer.
CO <sub>2</sub> COMM STOP	CO <sub>2</sub> module failure or communication failure	High	Stop using CO <sub>2</sub> alarm function, notify biomedical engineer or Manufacturer's service staff.
CO <sub>2</sub> INT RAM ERR	CO <sub>2</sub> module failure	High	
CO <sub>2</sub> INT ROM ERR	CO <sub>2</sub> module failure	High	
CO <sub>2</sub> ZERO REQUIRED	Zero calibration failure	Low	
CO <sub>2</sub> CHECK ADAPTER	The cannula is off or disconnected	Low	

Prompt message:

Message	Cause	Alarm Level
CO <sub>2</sub> STANDBY STATUS	Turn from measuring mode to standby mode, making the module in energy-saving status.	No alarm
CO <sub>2</sub> WARM UP	The CO <sub>2</sub> module is at warm-up state	No alarm

## 17.5 Maintenance and Cleaning

### NOTE:

- 1 Before cleaning the module, it should be disconnected from the monitor.
- 2 Do not immerse the module into liquid, or the module will be damaged.

### For cleaning C5 CO<sub>2</sub> module:

1. Use a cloth dampened with isopropyl alcohol 70%, a 10% aqueous solution of sodium hypochlorite (bleach), and disinfectant spray cleaners such as mild soap.
2. Wipe down with a clean water-dampened cloth to rinse and dry before use. Make certain that the sensor windows are clean and dry before reuse.

### For cleaning KM7002 CO<sub>2</sub> module:

1. The sampling cannula of KM7002 module is for disposable use. Do not sterilize or clean it for

- reuse on another patient.
2. When occlusion happens to the sampling system, check for any kink in the sampling cannula. If no kink is found, then check water trap after disconnecting sampling cannula from the water trap. If the occlusion message on the screen disappears, the sampling line must be replaced. If the occlusion message on the screen remains, the water trap must be replaced.
  3. No routine calibration is required in CO<sub>2</sub> module.



## Chapter 18 CO Measuring (Optional)

### 18.1 General

- 👁 The Cardiac Output (CO) measurement is performed by using Thermodilution method.
- 👁 The monitor can determine blood temperature, measure cardiac output, and perform hemodynamic calculations.
- 👁 You can have iced injecta using either the flow through system or individual syringes of injecta.
- 👁 You can perform up to 6 measurements before editing the average Cardiac Output.
- 👁 The prompt message on the screen will tell you when to inject.

### 18.2 Monitoring Procedure

#### 18.2.1 CO Measurement Procedure

1. Plug the CO interface cable into the CO socket on the front panel.
2. Attach the injectate probe connector and catheter thermistor connector to the appropriate parts of the cardiac output interface cable. (See the following figure18-1).
3. Pick the CO hot key in the parameter area on the screen to call up the **CO SELECT** menu and if necessary change the computation constant to the one appropriate to the catheter and volume of fluid used.

**NOTE:**

To replace the catheter thermistor, please enter the catheter computation coefficient into the **CO.CONST** item according to the instruction.

4. Pick **CO MEASURE** item in the **CO SELECT** menu to access the **CO MEASURE**.

**NOTE:**

You should appropriately set the injectate switch, because the CO calculation will be based on the **ON** or **OFF** of the injectate switch at the completion of measurement. No change shall be made after the switch is set to off.

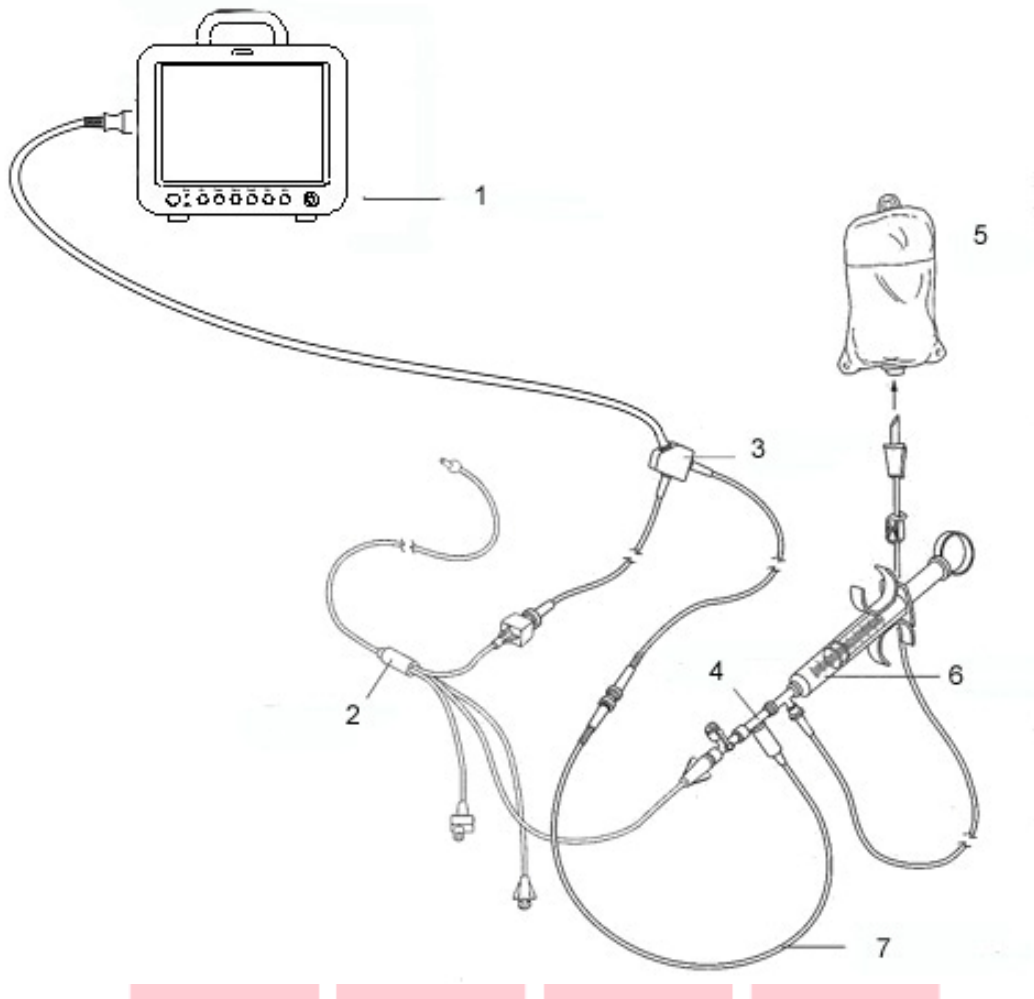

1: Monitor; 2: Thermodilution Catheter; 3: Cardiac Output Cable; 4: Injectate Sensor Housing; 5: Injectate; 6: Delivery System; 7: In-line injectate Temperature probe.

Figure 18-1 CO Sensor Connection

5. You can perform more than one measurement as required.
6. After the completion of the measurement (s), access the **CO MEASURE** window for **CO EDIT** to edit the measured data.

The procedure in details is described in the following pages.

### **WARNING**

Make sure that the computational constant for the measurement is appropriate to the catheter used.

### **NOTE:**

The blood temperature alarm will not function during CO measurement. It will resume automatically when the measurement is over.

## 18.2.2 CO Measuring

### **WARNING**

- 1 Make sure that appurtenance applied is in conformity with relevant Medical Device Safety Requirements.
- 2 Appurtenance should be avoided from contact with conductive metal body when being connected or applied.

### CO Measurement Window

Enter **CO MEASURE** window and start CO measurement. If CO transducer is not connected, the monitor will prompt “No Sensor, unable to measure CO!” on the screen.

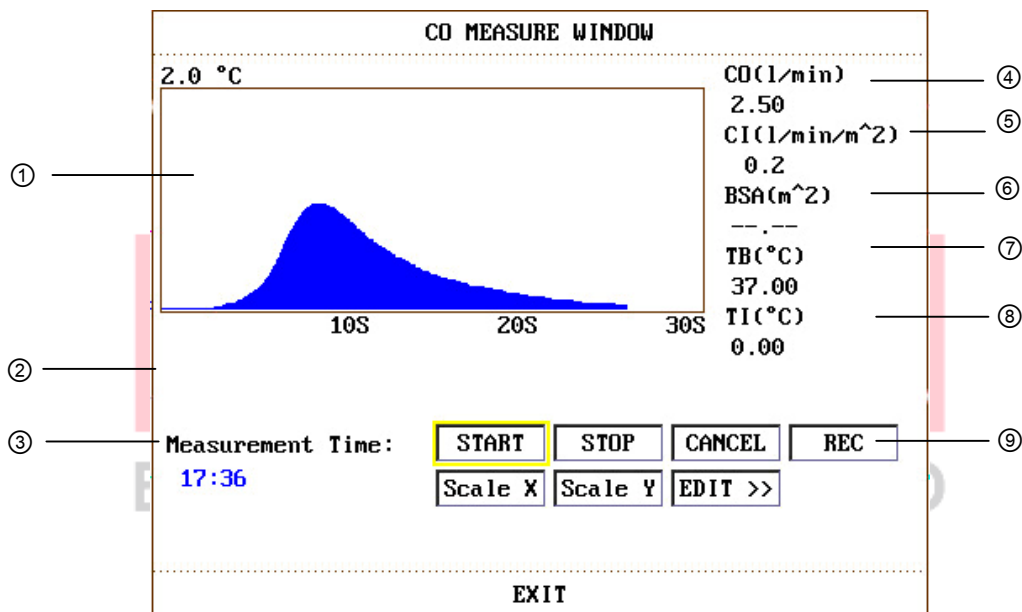

Figure 18-2 CO MEASURE WINDOW

#### **👁** Contents displayed in the **CO MEASURE WINDOW**:

- ① Measurement curve
- ② Prompt message area, refer to Measuring the Cardiac Output for details.
- ③ Start time of the measurement
- ④ CO: Cardiac Output
- ⑤ CI: Cardiac Index
- ⑥ BSA: Body Surface Area
- ⑦ TB: Blood Temperature
- ⑧ TI: Injectate Temperature. If necessary, change can be performed in the **CO SETUP** menu.
- ⑨ Function keys:



<b>START</b>	Start a measurement
<b>STOP</b>	If the blood temperature cannot resume in a considerably long time, the measurement could not stop automatically. Use this button to stop the measurement and display the CO, CI calculation result.
<b>CANCEL</b>	Cancel the processing measurement or cancel the result after measurement.
<b>REC</b>	Print out the curve.
<b>Scale Y</b>	Change the scale Y (temperature) value. Three modes are available: 0~0.5°C, 0~1°C, 0~2.0°C. Adjust the scale by the temperature differences. A smaller scale results in a larger curve.
<b>Scale X</b>	Change the Scale X (time) value. Two modes are available: 0~30s, 0~60s. If you start measurement in the 0~30s mode, it will be switched to 0~60s mode automatically if the measurement can not finish within 30 seconds. After the switch, no further adjustment can be made to the Scale X.
<b>Edit &gt;&gt;</b>	Enter the <b>CO MEASURE, CO EDIT</b>
<b>Exit:</b>	Press to exit the <b>CO MEASURE</b> .

### Measuring the Cardiac Output

Measurement should be taken when the message “**Ready for new measurement**” appears on the screen (② in the Figure 18-2). Press the **START** button, and then start injection. The thermodilution curve, current blood temperature and the injectate temperature are displayed during the measurement. Curve drawing will stop automatically when the measurement completes, and the the CO and CI (④ and ⑤ in Figure 18-2) will be calculated and displayed on the screen. The monitor will also display the CO in the Parameter Area, as well as the remaining time to the next measurement (② in the Figure 18-2).

To ensure the accuracy of the measurement, it is suggested that a reasonable interval should take place between two consecutive measurements. The length of the interval can be set in the **CO SETUP** menu (Time unit: second). The interval time counter (② in the Figure 18-2) is displayed on the screen. The next measurement can not be performed until the time reduces to zero and a prompt message “Ready for new measurement” appears.

### **NOTE:**

- 1 It is strongly recommended that the user must push the injector within four seconds after pressing the **START** button.
  - 2 It is strongly recommended that you wait at least 1 minute (or longer depending on the patient’s clinical condition) before starting the next measurement.
- Continue to repeat this procedure until you have completed the measurements you want to perform.
  - You can perform a maximum of 6 measurements editing. If you perform additional measurements the earliest measurement each time will be deleted. If any of the curves in the editing window is not selected for calculation (excluded from the averaging calculations), the place will be taken by the new measurement.

- Editing the CO measurement
- Pick the **EDIT** button to access the **WINDOW FOR CO EDIT** as shown below:

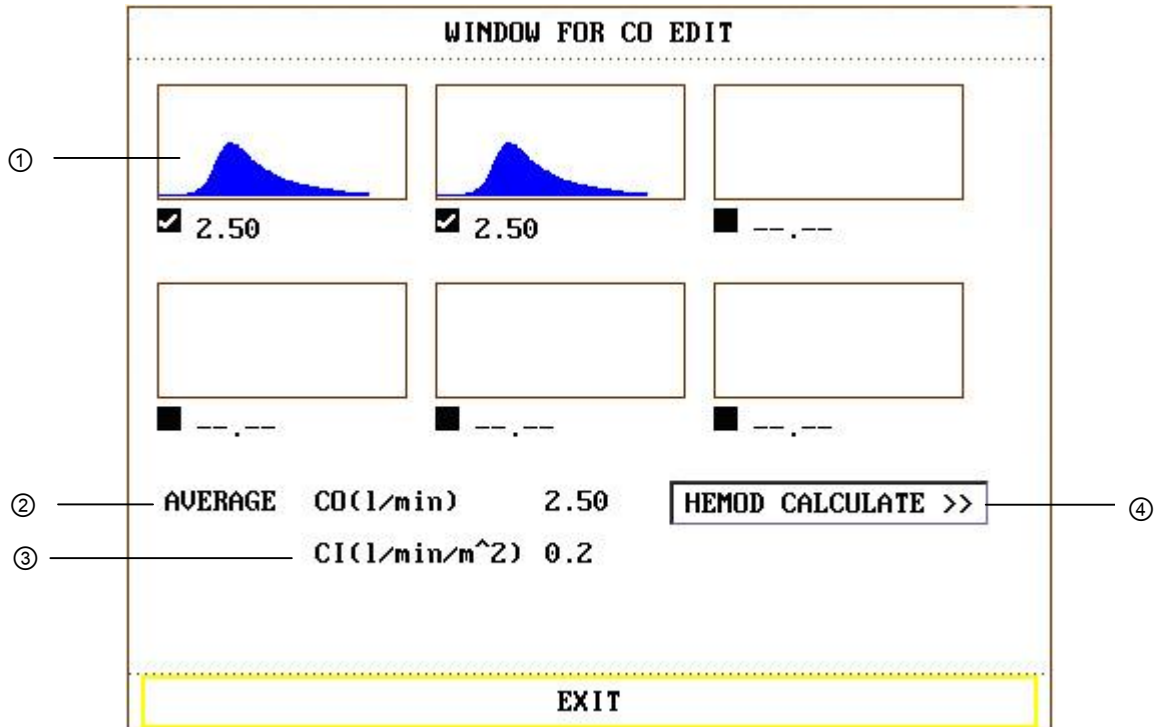

Figure 18-3 WINDOW FOR CO EDIT

👁 Contents displayed in the window:

1. Six curves of the 6 measurements and CO value (①)
2. Average value of CO (②)
3. Average value of CI (③)
4. Function button in the edit window (④).

👁 Editing operation:

Values of selected measurements can be averaged and stored in the CO item in the HEMOD menu as the basis for Hemodynamic calculations.

When you first enter the EDIT window, curves and CO values of valid measurements are highlighted, indicating these values are to be averaged. You can move the cursor to the curve of questionable measurements and press the rotary knob, dimmed waveforms and CO values will be excluded from the averaging calculation.

**NOTE:**

Dimmed curves can be picked and included in the averaging calculation.

### 18.2.3 Blood Temperature Monitoring

- Blood Temperature monitoring can function when CO measurement is not taken. The blood temperature is measured by the thermistor situated in the distal end of the flotation catheter in the pulmonary artery. (See the diagram below).
- The blood temperature alarm function will not work during the CO measurement. When the measurement ends, the function will automatically resume.
- The current blood temperature is displayed in the CO Parameter Area.

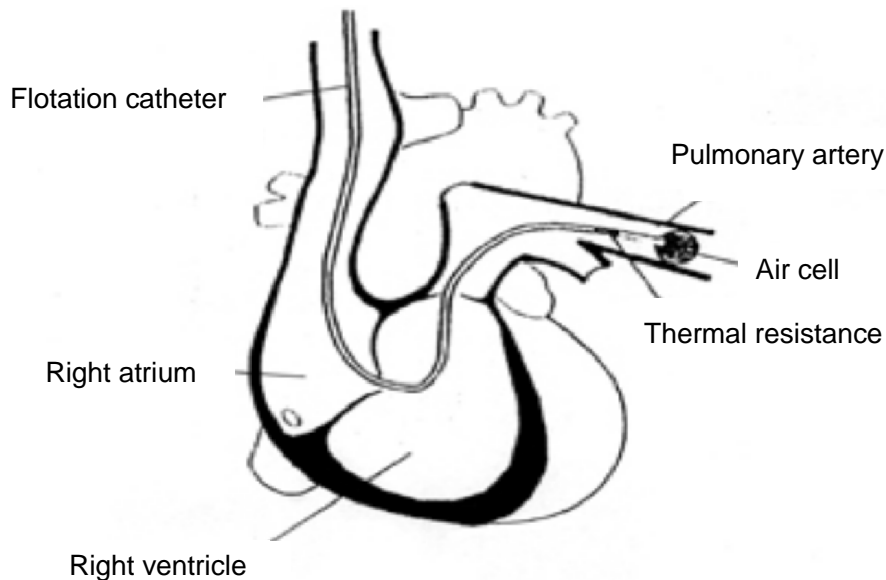

Figure 18-4 Thermodilution Catheter Site

## 18.3 CO SETUP

### CO Setup and Adjustment

Pick the CO hot key on the screen to call up the **CO SELECT** menu, and then pick the **CO SETUP** button to access the submenu as shown below:

CO SETUP			
ALM	ON	INJ. TEMP FROM	ON
ALM LEV	MED	INJ. TEMP	2.0
ALM REC	OFF	TEMP UNIT	°C
TB ALM HI	33.3	INT TIME(s)	30
TB ALM LO	30.0	DEFAULT >>	
CO.CONST	0.542		
EXIT			

Figure 18-5 CO SETUP Menu

## TB Alarm setup

- 👁️ **ALM**: Select **ON** to enable alarm prompt and data storage during TB alarm. Select **OFF** to disable audio alarm and prompt the  symbol beside TB numeric.

**WARNING**

During the cardiac output measurement procedure the blood temperature alarms will be inactive.

- 👁️ **ALM REC**: Select **ON** to enable recording during the TB alarm.
- 👁️ **ALM LEV**: selectable from level **HIGH**, level **MED** to level **LOW**. Level **HIGH** represents the most serious case.
- 👁️ **TB ALM HI** and **TB ALM LO**: used to set up the upper and lower alarm limit for TB. Alarm occurs when the measured TB exceeds set alarm high limit or falls below alarm low limit.

The default **TB ALM LO** is **36.0°C**, The default **TB ALM HI** is **39.0°C**.

TB alarm limits:

	Max. alarm high	Min. alarm low	Step
TB	43	23	0.1

- 👁️ **CO.CONST**

It represents the computation constant related to the catheter and injectate volume. After replacing the catheter, you should adjust this constant according to the instruction.

**WARNING**

Make sure the computational constant for the measurement is appropriate to the catheter used.

- ④ **INT TIME (s)**: It refers to the minimum time interval between two measurements. It is in second units. The adjustment range is 5 to 300 seconds in increment being 5 seconds.
- ④ **INJ. TEMP FROM**: Pick **ON** or **OFF** to select from 2 ways of obtaining the injectate temperature.
  - ON**: the system obtains the injectate temperature through sampling.
  - OFF**: directly display the injectate temperature obtains from the **INJ. TEMP**.
- ④ **INJ. TEMP**: When the **INJ. TEMP FROM** is **OFF**, the user can set the injectate temperature between 0~27 with the increment being 0.1°C.
- ④ **TEMP UNIT**: °C for Celsius degree, °F for Fahrenheit degree.
- ④ **DEFAULT>>**: Pick this item to access the **CO DEFAULT CONFIG** dialog box, in which the user may select whether the **FACTORY DEFAULT CONFIG** or the **USER DEFAULT CONFIG** is to be used. After selecting any of the items and exiting the dialog box, the system will pop up the dialog box asking for the user's confirmation.
- ④ **Exit**: Used to exit the menu and return to the main screen.

## 18.4 Hemodynamic Calculation

### ④ HEMO Calculation

Pick the **HEMO CALCULATE** in the **WINDOWS FOR CO EDIT** Window to display input parameter value and list calculation results.

HEMOD WINDOW			
<b>CALCULATE RESULT:</b>			
CI(l/min/m <sup>2</sup> )	--.-	EF(%)	--.-
SV(ml)	--.-	SUI(ml/m <sup>2</sup> )	--.-
SVR(DS/cm <sup>5</sup> )	--.-	SVRI(DScm <sup>2</sup> /cm <sup>5</sup> )	--.-
PVR(DS/cm <sup>5</sup> )	--.-	PVRI(DScm <sup>2</sup> /cm <sup>5</sup> )	--.-
LCW(kg-m)	--.-	LCWI(kg-m/m <sup>2</sup> )	--.-
LUSW(g-m)	--.-	LUSWI(g-m/m <sup>2</sup> )	--.-
RCW(kg-m)	--.-	RCWI(kg-m/m <sup>2</sup> )	--.-
RUSW(g-m)	--.-	RUSWI(g-m/m <sup>2</sup> )	--.-
BSA(m <sup>2</sup> )	--.-		
<b>INPUT VALUE:</b>			
PAWP(mmHg)	<input type="text" value="--.-"/>	AP MAP(mmHg)	<input type="text" value="--.-"/>
CVP(mmHg)	<input type="text" value="--.-"/>	PA MAP(mmHg)	<input type="text" value="--.-"/>
CO(l/min)	<input type="text" value="2.50"/>	HT(cm)	<input type="text" value="175.0"/>
HR	<input type="text" value="--.-"/>	WT(kg)	<input type="text" value="70.0"/>
LV_D	<input type="text" value="--.-"/>		
<input type="button" value="CALCULATE"/>		<input type="button" value="RECORD"/>	
<b>EXIT</b>			

Figure 18-6 HEMOD WINDOW

Turn the rotary knob, you can change the value of the parameter that the cursor appears on by picking it. Pick **CALCULATE** after input of all parameter values, the calculation results will be displayed in the window. Picking **REC** can print out all the calculation results.

Input parameters value:

- 👁 **PAWP** Pulmonary Artery Wedge Pressure
- 👁 **CVP** Central Venous Pressure
- 👁 **CO** Cardiac Output
- 👁 **HR** Heart Rate
- 👁 **AP MAP** Mean Artery Pressure
- 👁 **LV\_D** Left Ventricular Diameter
- 👁 **AP MAP** Mean Pulmonary Artery Pressure
- 👁 **HT** Height
- 👁 **WT** Weight

**CI** Cardiac index  
**BSA** Body surface area  
**SV** Stroke volume

<b>SVI</b>	Stroke volume index
<b>SVR</b>	Systemic vascular resistance
<b>SVRI</b>	Systemic vascular resistance index
<b>PVR</b>	Pulmonary vascular resistance
<b>PVRI</b>	Pulmonary vascular resistance index
<b>LCW</b>	Left cardiac work
<b>LCWI</b>	Left cardiac work index
<b>RCW</b>	Right cardiac work
<b>RCWI</b>	Right cardiac work index
<b>LVSW</b>	Left ventricular stroke work
<b>LVSWI</b>	Left ventricular stroke work index
<b>RVSW</b>	Right ventricular stroke work
<b>RVSWI</b>	Right ventricular stroke work index
<b>EF</b>	Ejection fraction

## 18.5 Alarm Information and Prompt

Among physiological alarms, those belonging to the type that the parameter has exceeded the limits may active the recorder to automatically output the parameters and related measured waveforms when the alarm occur on the condition that the alarm record switch in the related menu is **ON**.

Tables below describe the possible physiological alarms, technical alarms and prompt messages occurring during CO measurement.

Physiological alarms:

Message	Cause	Alarm level
TB HIGH	TB measuring value is above upper alarm	User-selectable
TB LOW	TB measuring value is below lower alarm	User-selectable

Technical alarms:

Message	Cause	Alarm Level	What to do
CO INIT ERR	CO module failure	High	Stop using measuring function of CO module, notify biomedical engineer or Manufacturer's service staff.
CO INIT ERR 1			
CO INIT ERR 2			
CO INIT ERR 3			

CO INIT ERR 4	CO module failure	High	Stop using measuring function of CO module, notify biomedical engineer or Manufacturer's service staff.
CO INIT ERR 5			
CO INIT ERR 6			
CO INIT ERR 7			
CO INIT ERR 8			
CO COMM STOP	CO module failure or communication failure	High	Stop using measuring function of CO module, notify biomedical engineer or Manufacturer's service staff.
CO COMM ERR	CO module failure or communication failure	High	Stop using measuring function of CO module, notify biomedical engineer or Manufacturer's service staff.

Prompt message (general alerts):

Message	Cause	Alarm Level
CO TEMP EXCEED	TB measuring value is beyond measuring range.	High
CO MEASURE NEED PARAMENT	CO measuring needs parameters	High
HEMOD CALCULATE NEED PARAMENT	HEMOD calculation needs parameters	High
CO TB SENSOR OFF	TB measuring cable falls off the monitor	Low
CO TI SENSOR OFF	Sensor or cables fall off the monitor	Low

## 18.6 Maintenance and Cleaning

### **WARNING**

Before cleaning the monitor or the transducer, make sure that the equipment is switched off and disconnected from the power line.



## CO Cable Cleaning

1. If adhesive tape residue must be removed from the transducer cable, double seal tape remover is effective and will cause a minimum of damage to the cable if used sparingly. Acetone, Alcohol, Ammonia, Chloroform, or other strong solvents are not recommended because they will eventually damage the vinyl cabling.
2. Sponge the cable with warm water and soap, or another suitable cleaning solution, and dry. Do not immerse them in water.
3. Check each cable for corrosion, cracks and deterioration.
4. Gas Sterilization

For more complete asepsis, use gas sterilization.

- 👁 Remove obvious contamination by using the cleaning procedure described previously. To inhibit the formation of ethylene glycol when ethylene oxide gas is used as the disinfectant, the transducer should be completely dry.
- 👁 Follow the operating instructions provided by the manufacturer of the gas disinfectant.

---

### **WARNING**

Do not autoclave the cable or heat it above 75°C (167°F). The cable should be stored in an environmental temperature between -20°C and 75°C (-68°F and 167°F). It should be hung up or laid flat to prevent damage to the cable.

---

EQUIPAMIENTO MEDICO

## Chapter 19 Anesthetic Gas Measuring (Optional)

### 19.1 General

GAS module is used to measure respiratory and anesthetic gases of a patient during anesthesia. This module provides Et (end tidal) values and inspired values of various gases listed below.

CO<sub>2</sub>: Here it represents the measured EtCO<sub>2</sub> value (maximum expired gas value-maximum expired gas value tested during expiring period).

N<sub>2</sub>O: Nitrous oxide.

O<sub>2</sub>: Optional function.

AwRR: Respiring time per minute.

The system can simultaneously display the waveforms of 4 anesthetic gases: CO<sub>2</sub>, N<sub>2</sub>O, O<sub>2</sub> and an GAS waveform. The default is to display CO<sub>2</sub> waveform.

Parameters that can be displayed simultaneously are CO<sub>2</sub>, N<sub>2</sub>O, O<sub>2</sub> and an AA (it refers to anesthetic gas value: DES, ISO, ENF, SEV, HAL). In addition, inspired and expired values are displayed at the same time with MAC (Minimal Alveolar Concentration) or BAL (Balance gas) and AwRR.

Definitions of parameter:

CO<sub>2</sub>: Carbon dioxide

N<sub>2</sub>O: Nitrous oxide

O<sub>2</sub>: Oxygen

AwRR: Air way respiration rate (respiring time per minute)

Halothame: HAL

Isoflurane: ISO

Enflurane: ENF

Sevoflurane: SEV

Desflurane: DES

There are two types of GAS modules for optional configuration. The default configuration is AION 02 module, so if using the 03 module, you should setup in **MAINTAIN** menu. See details in 19.3 for menu setup. The following is the **STANDARD SCREEN** for using AION 02 module.

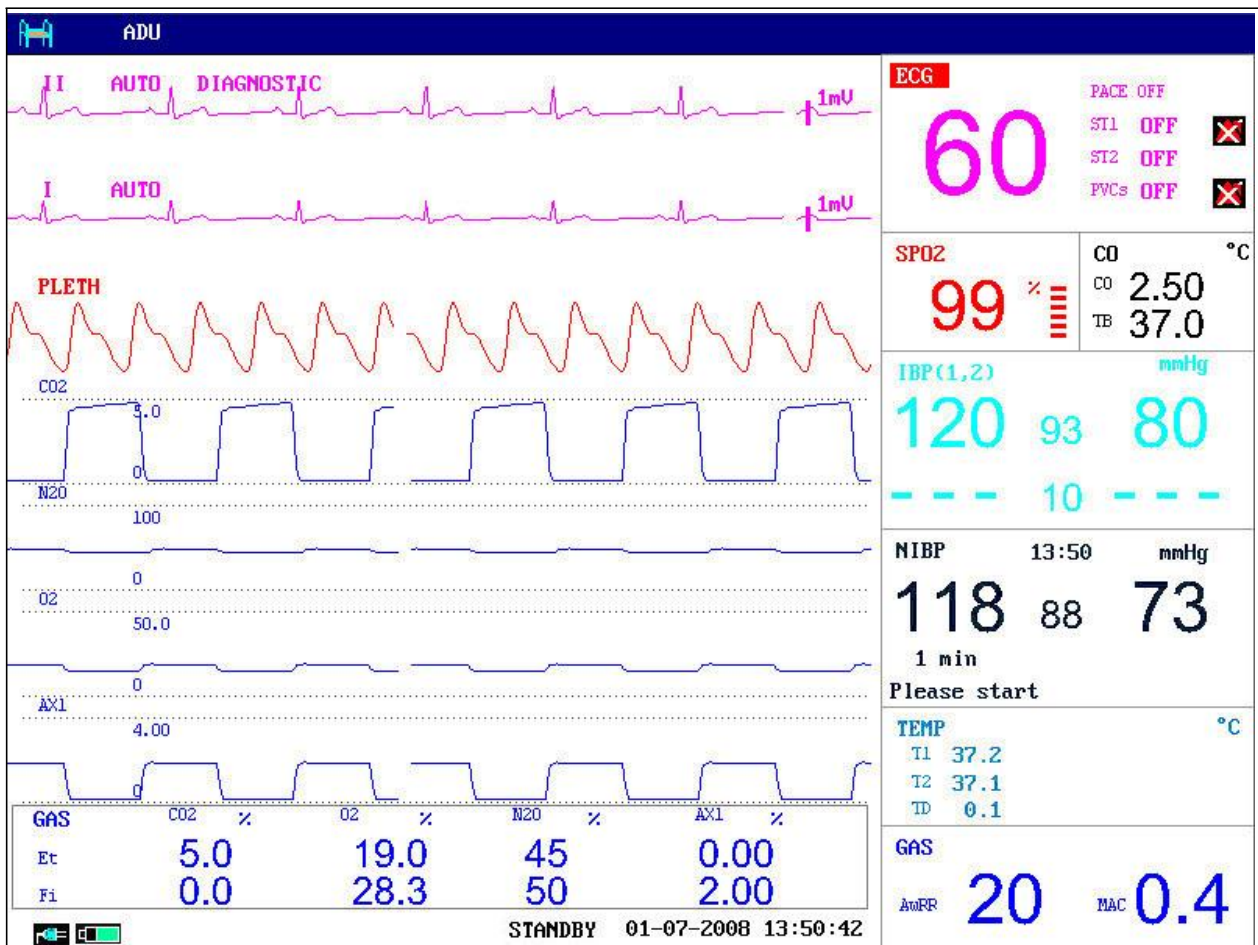

Figure 19-1 GAS STANDARD SCREEN

**NOTE:**

- 1 The system can only display the waveform and value of one anesthetic agent at a time.
- 2 The Analyzer determines the concentrations of carbon dioxide, nitrous oxide, Halothane, Enflurane, Isoflurane, Sevoflurane and Desflurane in any combination. It automatically identifies which agents are present in a gas mixture.
- 3 The mobile phone should be turned off during monitoring, because the disturbance may cause the inaccurate readings.

## 19.2 Measuring Principle and Operating Process

### Principle for measuring Anesthetic gas:

Anesthetic gas can absorb infrared rays. By using this principle, we can measure the concentration of anesthetic gas.

Gases that can be measured using GAS module are all able to absorb infrared rays. Besides, each gas has its own absorption characteristic. First the gas to be measured is driven into a sample cell. Then optic infrared filter selects the infrared ray with special wavelength to penetrate this gas. For a given volume, the higher the gas concentration is, the more infrared rays are absorbed. This means that the higher the concentration of the absorbed infrared is, the fewer infrared rays there

are to have penetrated the gas. We may first measure the quantity of the infrared rays that have penetrated the gas and then calculate the gas concentration via specialized formula. If you desire to measure multiple gases, you should install various infrared filters in the GAS module.

### Principle for measuring oxygen:

Within the range of wavelength mentioned above, oxygen does not absorb infrared rays. Therefore we have to measure oxygen concentration by taking advantage of its paramagnetic characteristic. Inside the sensor of the oxygen module, there are two glass balls filled up with Nitrogen. These two glass balls are suspended into symmetric non-uniform magnetic field, pointing into the direction away from the most intensive part of the field. This device is surrounded by oxygen having paramagnetic characteristic. By this means, this device is actually further pushed out of the field by the oxygen having relatively more intensive paramagnetic characteristic. The force moment acted on this device is proportional to the paramagnetic intensity of the surrounding gas, and therefore also proportional to oxygen concentration.

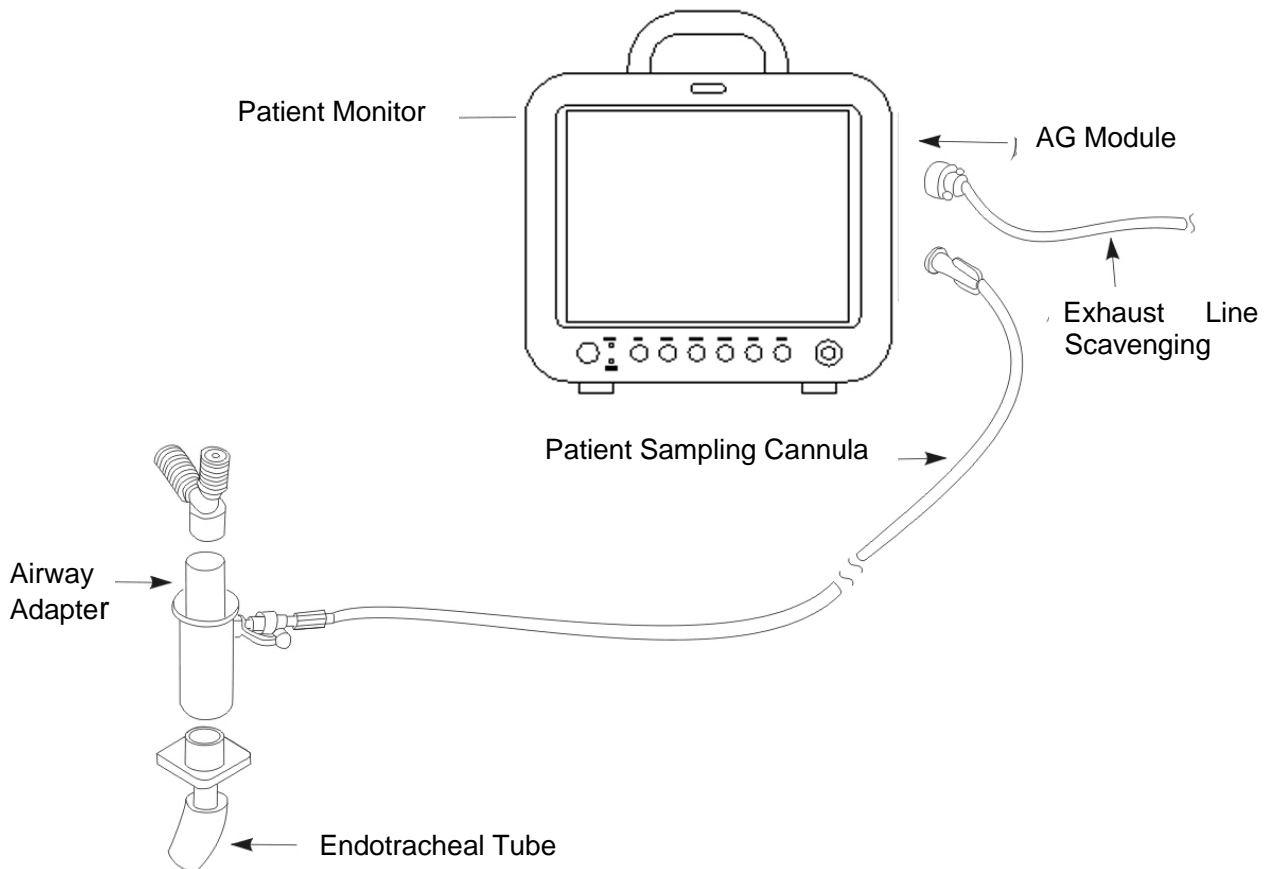

Figure 19-2 Connection diagram for measuring GAS

There are two types of oxygen sensor: Servomex Paramagnetic oxygen sensor and Galvanic oxygen sensor. Here we apply Galvanic oxygen sensor. The oxygen sensor should be connected before measuring gas, even though the user does not measure oxygen. Or the air way system may leak and induce the incorrect readings.

---

**WARNING**

- 1 The exhausted or damaged Galganic oxygen sensor and prolonged response time caused by incorrect operation may induce incorrect readings.
  - 2 The Galganic oxygen sensor should be calibrated before used for the first time. The correctly fixed sensor will do pressure calibration and gain calibration automatically.
  - 3 The replaced oxygen sensor should be calibrated.
  - 4 It is recommended that 100% O<sub>2</sub> should be used for calibration, which will improve the O<sub>2</sub> measuring precision in a high concentration environment.
  - 5 The sensor should be calibrated for measuring high concentration O<sub>2</sub>.
  - 6 Ensure tight connection when installing the filter. Any leakage in the system will result in incorrect readings, because this leakage will make the environmental air mix up with patient gas.
  - 7 The evacuated gas must be handled in a suitable manner so as not to contaminate the ambient air in and around the host instrument. The gas should be filtered or return the gas to the recycle system.
  - 8 Proper error handling must be implemented in the host instrument in order to minimize the following risks: Incorrect gas data due to incorrect gas flow or inadequate power supplies; Incorrect zero reference measurement due to occlusion of zero reference inlet, depleted oxygen Sensor, Software failures or hardware failures.
  - 9 The water trap, sampling line and airway adapter should be disposed of in accordance with local regulations for contaminated and biologically hazardous items.
  - 10 Do not use adult type water traps and/or sampling lines on neonates, this is to avoid high sampling flow.
  - 11 The sampling line shall not be connected to the patient circuit during pressure calibration of the Galvanic Oxygen Sensor.
  - 12 If the water quantity reached the scale on the water trap, you should clean it immediately.
  - 13 Any other ambient H<sub>2</sub>O partial pressure will dilute the gas sample to different extents, causing a certain measurement error. Under typical operating conditions however, this effect is not noticeable. An increase in the ambient H<sub>2</sub>O partial pressure to 30 hPa (i.e. 28°C, 80% RH or 33°C, and 60% RH) will cause a general error for all gases of only -2%REL.
  - 14 To protect the module against contamination, always use bacteria filter because without it, bacteria and liquid may directly enter the GAS module and lead to system contamination, clog or incorrect reading. In order to prevent clog, dispose the filter each time after it is used on a patient. Do not try to disinfect or clean a used filter.
  - 15 Only use the sampling cannula recommended especially for the system. Using other sampling cannulas may reduce the performance and reliability of the GAS module.
  - 16 If the sampling cannula is tangled up, do not use it because the cannula in this condition may cause clog or leakage.
-

**NOTE:**

- 1 Since the measurement involves a chemical reaction, the Galvanic oxygen sensor is gradually consumed during the process (also when the equipment is not in use), and requires replacement at regular intervals.
- 2 The Analyzer needs to perform zero reference measurements at regular intervals to maintain gas measurement accuracy. A reference measurement is performed every 4 hours under steady state conditions.

## 19.3 Menus

### 19.3.1 GAS SETUP

There are two ways to enter the **GAS SETUP** menu.

1. Use the rotary knob to select the GAS hot key in the parameter area to display the **GAS SETUP** menu.
2. Press the SETUP button on the GAS module to display the **GAS SETUP** menu.

GAS SETUP			
AGENT	ENF	O2 COMPEN	OFF
CO2 UNIT	mmHg	SWEEP	12.5
O2 UNIT	kPa	WORK MODE	STANDBY
N2O UNIT	%	ALARM SETUP >>	
AA UNIT	%	ADJUST WAVE AMP >>	
PUMP RATE	MED	DEFAULT >>	
EXIT			

Figure 19-3 GAS SETUP

Detailed information about each item in the **GAS SETUP** menu is:

- 👁 **AGENT:** used to select the names of the anesthetic gases to be monitored. If you use AION 02 module which can only identify one kind of gas, you should set this item. But you need not set this when using AION 03 module which can identify five kinds of agents.
- 👁 **CO<sub>2</sub> UNIT:** used to select the display unit of CO<sub>2</sub>.
- 👁 **O<sub>2</sub> UNIT:** used to select the display unit of O<sub>2</sub>.
- 👁 **N<sub>2</sub>O UNIT:** used to select the display unit of N<sub>2</sub>O.

- ① **AA UNIT:** used to select the display unit of GAS (the anesthetic gas to be monitored).
- ① **PUMP RATE:** used to select the appropriate pump rate.
- ① **O<sub>2</sub> COMPEN:** O<sub>2</sub> compensation switch. When the O<sub>2</sub> concentration is larger than 60% and O<sub>2</sub> is not being monitored, turn on the switch.

This item is used for Servomex Paramagnetic oxygen sensor. Here we use Galvanic oxygen sensor, so this item need not be set.

- ① **SWEEP:** used to select the speed to scan the screen waveforms.
- ① **WORK MODE:** to monitor the anesthetic gas, select the **MEASURE** option. Otherwise, select the **STANDBY** option.

**NOTE:**

To prolong the lifespan of oxygen sensor, the user should set the **WOKE MODE** to **STANDBY** before turning off the monitor, so the gas left in the monitor will be cleaned up. Or the gas will be left inside the monitor when it is turned off at **MEASURE** mode.

- ① **ALARM SETUP>>:** used to enter the **ALARM SETUP** submenu.
- ① **ADJUST WAVE AMP>>:** used to enter the **ADJUST WAVE AMP** submenu, in which you may select the appropriate waveform amplitude for display.
- ① **DEFAULT>>:** used to enter the **GAS DEFAULT CONFIG** submenu, you can use the information this submenu to initialize all menus.

**Setup for using AION O2 Module**

The AION O2 module can only identify one kind of anesthetic gas, so the user should set the **AGENT** in **GAS SETUP**.

The default setting is AION O2 module. Set the **WORK MODE** in **GAS SETUP** to **MEASURE**, the GAS monitoring can be executed. It only displays AX1 for one kind of anesthetic gas. The **STANDARD SCREEN** is:

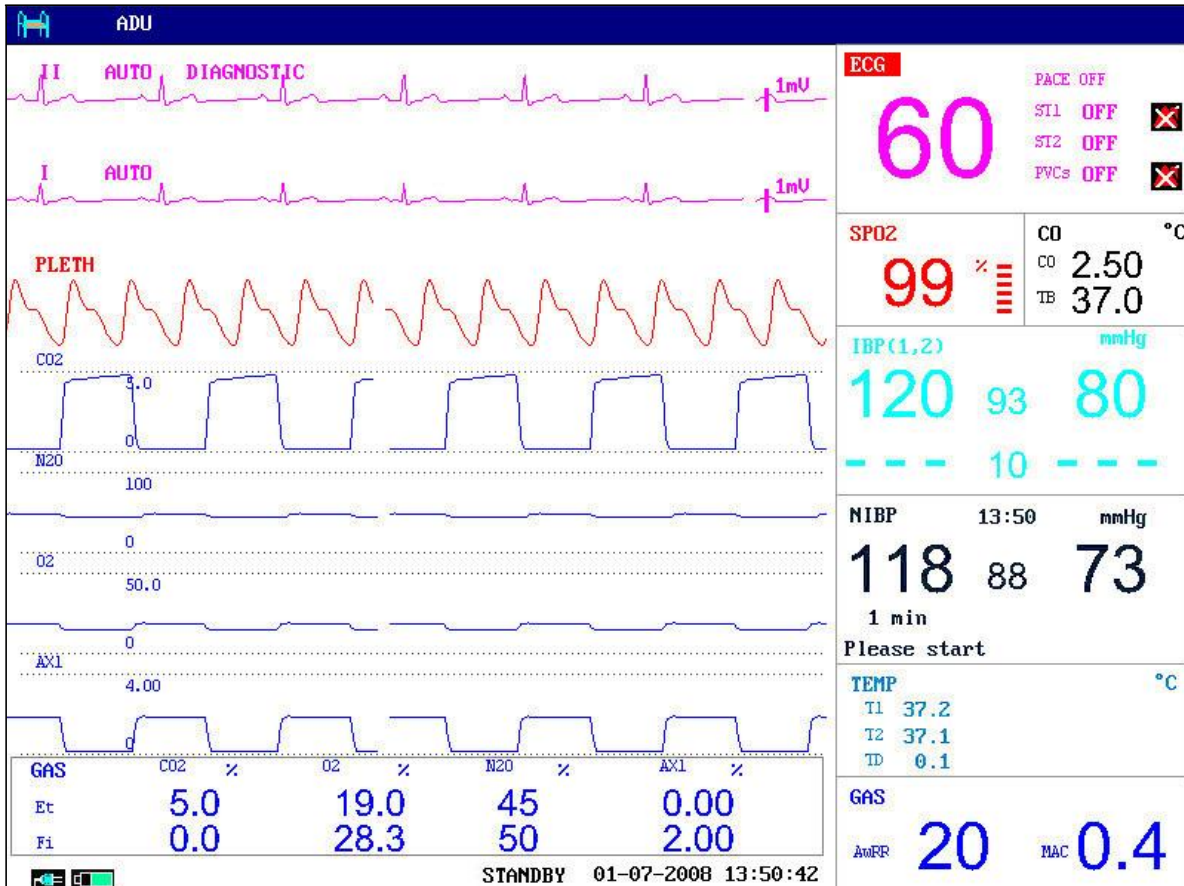

Figure 19-4 Standard screen for using AION 02 module

**NOTE:**

For AION 02 module, The **AGENT** in **GAS SETUP** should be set, or it will lead to incorrect readings.

**Setup for using AION 03 module**

The AION 03 module can automatically identify five kinds of anesthetic gases. The default setting is AION 02 module. So the user should set module type in menu. Enter **SYSTEM MENU > MAINTAIN > FACTORY MAINTAIN > SELECT MODULE**, and set the **AG MODULE TYPE** to 03.



SELECT MODULE	
SPO2 DEV	A6
NIBP DEV	U6
IBP DEV	C2
ECG DEV	E6
CO2 DEV	CPT
AG MODULE TYPE	02
EXIT	

Figure 19-5 Select Module

**NOTE:**

For using AION 02 GAS module, the **AG MODULE TYPE** item in the **OTHER SETUP** need not be set. The default setting is AION 02 module.

After setup, the user should turn off the monitor and restart it. After POST and entering main interface, set the **WORK MODE** in **GAS SETUP** from **STANDBY** to **MEASURE**. There will be a prompt in the Information area on the interface. Such as:

AG IS STARTING

AG WARM UP

The GAS module needs about 10min to warm up, it need 40s-50s from the startup until the baseline appears. Then it enters Full accuracy mode. If the user starts measuring when warm-up is not finished successfully, it may lead to inaccurate readings.

**NOTE :**

Make sure the 10 minutes' warm-up is finished successfully, then it enters Full Accuracy mode. It is recommended to measure in Full Accuracy mode in clinical monitoring for measuring precision.

When using AION 03 module, it can display AX1 and AX2 on interface. See the following figure:

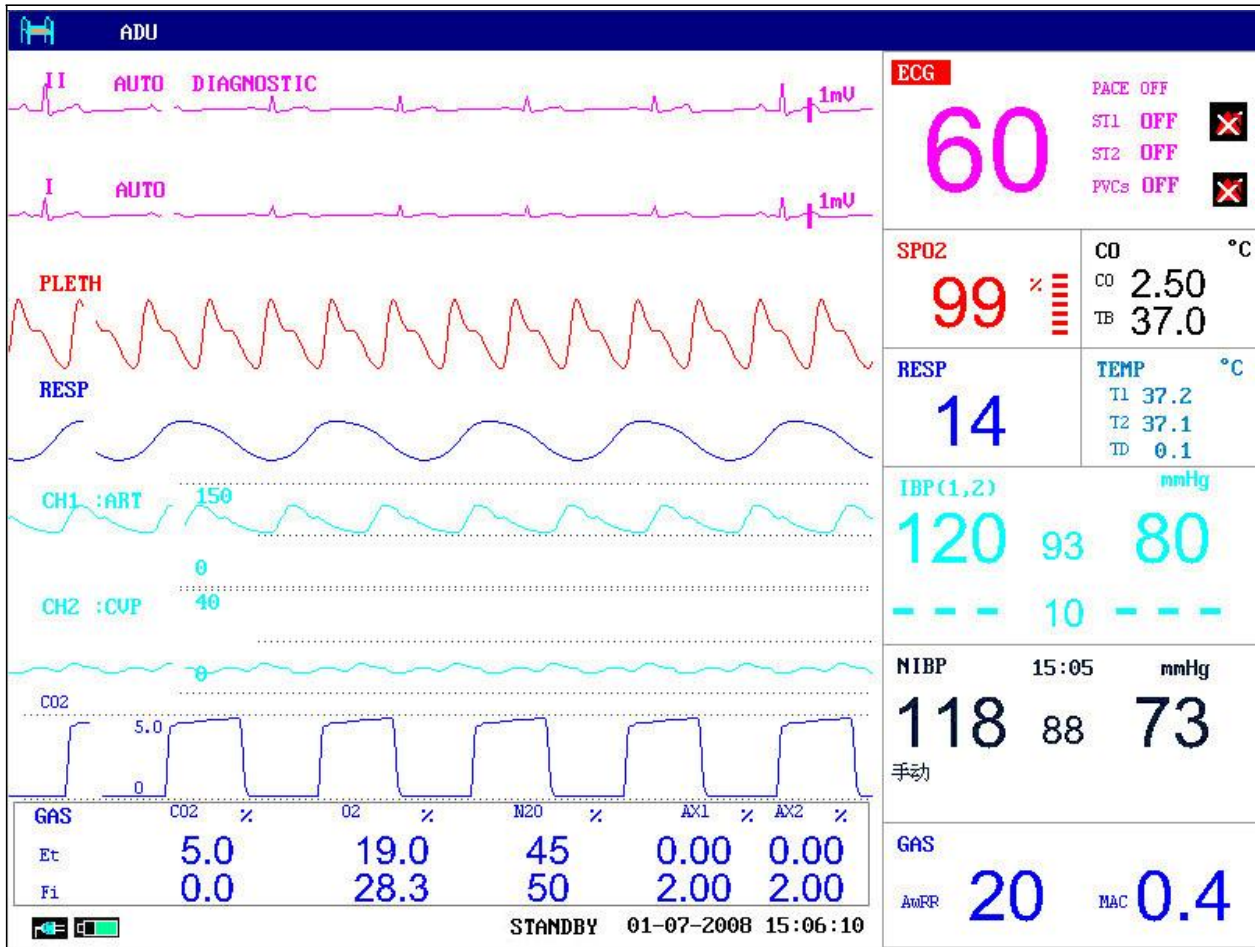

Figure 19-6 Standard screen for using AION 03 module

**NOTE :**

Occasionally it displays beelines in GAS waveform area, which is caused by automatic zero calibration of module.

**Calibration**

Enter **SYSTEM MENU > MAINTAIN > USER MAINTAIN > OTHER SETUP > GAS SPAN CALIBRATION** for GAS calibration. This calibration is operated by the user.

The calibrating gas concentration of anesthetic gas should be higher than 1.5%, CO<sub>2</sub> is higher than 1.5%, N<sub>2</sub>O is higher than 40%, O<sub>2</sub> is higher than 40%. The main screen is as follows:

GAS SPAN CALIBRATION			
	‰	‰	
Co2 Conc :	---	<input style="width: 50px; height: 15px;" type="text"/> (>1.5)	
O2 Conc :	---	..... (>40)	
N2o Conc :	---	..... (>40)	
AA Conc :	---	..... (>1.5)	
Agent ID :	NONE		
	CONFIRM	CALIBRATE	
<table border="1" style="width: 100%; border-collapse: collapse; text-align: center;"> <tr> <td>. 0 1 2 3 4 5 6 7 8 9 DEL OK</td> </tr> </table>			. 0 1 2 3 4 5 6 7 8 9 DEL OK
. 0 1 2 3 4 5 6 7 8 9 DEL OK			
EXIT			

Figure 19-7 Gas span calibration

Fill the concentration of calibrating gas in the right blank, and compare it with the measured concentration if the two values have discrepancy, select **CALIBRATION** to do calibration. If the two values are the same, select **CONFIRM** to exit the menu.

**NOTE:**

- 1 Make sure the discrepancy of calibrating gas is less than ±1;
- 2 The gas flux should be set in the range of 10 ml/min - 50ml/min;
- 3 The calibrating gas concentration of anesthetic gas should be higher than 1.5%, CO2 is higher than 1.5%, N2O is higher than 40%, O2 is higher than 40%;
- 4 Set up menu according to the O2 module or O3 module;
- 5 The discrepancy between calibrated value and measured value is less than 15%;
- 6 The calibration should be done before high concentration O2 measuring.

**19.3.2 GAS ALARM SETUP**

In the **GAS SETUP** menu, select **ALARM SETUP**, and the **ALARM SETUP** menu pops up.

ALARM SETUP			
ALM	ON	EtO2 ALM HI	90.0
ALM LEV	MED	EtO2 ALM LO	18.0
ALM REC	OFF	FiO2 ALM HI	88.0
EtCO2 ALM HI	50	FiO2 ALM LO	18.0
EtCO2 ALM LO	15	AWRR ALM HI	30
FiCO2 ALM HI	3	AWRR ALM LO	8
FiCO2 ALM LO	0	OTHER SETUP >>	
EXIT			

Figure 19-8 ALARM SETUP menu

- ① **ALM**: when this switch is **ON**, if CO<sub>2</sub> has alarm, the system will give alarm prompt and save the alarm information. When this switch is **OFF**, the system will not trigger alarm, instead it will display  beside CO<sub>2</sub> in the Parameter Area.
- ① **ALM LEV**: there are three options: **HIGH**, **MED**, **LOW**. **HIGH** refers to the most serious alarm, followed by **MED** and **LOW** in the order of descending seriousness. Changing of **LEV** only affects the physiological alarm levels of CO<sub>2</sub> parameter (including the upper and lower alarm limits of EtCO<sub>2</sub>, the upper and lower alarm limits of InsCO<sub>2</sub>, the upper and lower alarm limits of AwRR). The default alarm level is **MED**.
- ① **ALM REC**: if it is **ON**, when CO<sub>2</sub> parameter has alarm, the recorder will output the alarm information. The default is **OFF**.
- ① **EtCO<sub>2</sub> ALM HI**: used to adjust the upper alarm limit of EtCO<sub>2</sub>. When the measured value is larger than EtCO<sub>2</sub> upper alarm limit, the **EtCO<sub>2</sub> HIGH** message is displayed on the screen. In **UNLATCH** mode, this message disappears when the measured value is below the upper alarm limit.
- ① **EtCO<sub>2</sub> ALM LO**: used to adjust the lower alarm limit of EtCO<sub>2</sub>. When the measured value is smaller than EtCO<sub>2</sub> lower alarm limit, the **EtCO<sub>2</sub> LOW** message is displayed on the screen. In the **UNLATCH** mode, this message disappears when the measured value is above the lower alarm limit.
- ① **FiCO<sub>2</sub> ALM HI**: used to adjust the upper alarm limit of FiCO<sub>2</sub>. When the measured value is larger than FiCO<sub>2</sub> upper alarm limit, the **FiCO<sub>2</sub> HIGH** message is displayed on the screen. In **UNLATCH** mode, this message disappears when the measured value is below the upper alarm limit.
- ① **FiCO<sub>2</sub> ALM LO**: used to adjust the lower alarm limit of FiCO<sub>2</sub>. When the measured value is smaller than FiCO<sub>2</sub> lower alarm limit, the **FiCO<sub>2</sub> LOW** message is displayed on the screen. In the **UNLATCH** mode, this message disappears when the measured value is above the lower alarm limit.
- ① **EtO<sub>2</sub> ALM HI**: used to adjust the upper alarm limit of EtO<sub>2</sub>. When the measured value

is larger than EtO<sub>2</sub> upper alarm limit, the **EtO<sub>2</sub> HIGH** message is displayed on the screen. In **UNLATCH** mode, this message disappears when the measured value is below the upper alarm limit.

- ① **EtO<sub>2</sub> ALM LO**: used to adjust the lower alarm limit of EtO<sub>2</sub>. When the measured value is smaller than EtO<sub>2</sub> lower alarm limit, the **EtO<sub>2</sub> LOW** message is displayed on the screen. In the **UNLATCH** mode, this message disappears when the measured value is above the lower alarm limit.
- ① **FiO<sub>2</sub> ALM HI**: used to adjust the upper alarm limit of FiO<sub>2</sub>. When the measured value is larger than FiO<sub>2</sub> upper alarm limit, the **FiO<sub>2</sub> HIGH** message is displayed on the screen. In **UNLATCH** mode, this message disappears when the measured value is below the upper alarm limit.
- ① **FiO<sub>2</sub> ALM LO**: used to adjust the lower alarm limit of FiO<sub>2</sub>. When the measured value is smaller than FiO<sub>2</sub> lower alarm limit, the **FiO<sub>2</sub> LOW** message is displayed on the screen. In the **UNLATCH** mode, this message disappears when the measured value is above the lower alarm limit.
- ① **AwRR ALM HI**: used to adjust the upper alarm limit of AwRR. When the measured value is larger than AwRR upper alarm limit, the **AwRR HIGH** message is displayed on the screen. In **UNLATCH** mode, this message disappears when the measured value is below the upper alarm limit.
- ① **AwRR ALM LO**: used to adjust the lower alarm limit of AwRR. When the measured value is smaller than AwRR lower alarm limit, the **AwRR LOW** message is displayed on the screen. In the **UNLATCH** mode, this message disappears when the measured value is above the lower alarm limit.
- ① **OTHER SETUP>>**: used to enter the other **ALARM SETUP** menus.
- ① **EXIT**: used to close this **ALARM SETUP** menu.

After selecting **OTHER SETUP >>** item in the **ALARM SETUP** menu, the following **ALARM SETUP** menu pops up.

ALARM SETUP			
EtN <sub>2</sub> O ALM HI	55	ETAA ALM LO	0.0
EtN <sub>2</sub> O ALM LO	0	FiAA ALM HI	6.0
FiN <sub>2</sub> O ALM HI	53	FiAA ALM LO	0.0
FiN <sub>2</sub> O ALM LO	0	APNEA ALM	20S
ETAA ALM HI	8.0		
EXIT			

Figure 19-9 ALARM SETUP menu

- ① **EtN<sub>2</sub>O ALM HI**: used to adjust the upper alarm limit of EtN<sub>2</sub>O. When the measured

value is larger than EtN<sub>2</sub>O upper alarm limit, the **EtN<sub>2</sub>O HIGH** message is displayed on the screen. In **UNLATCH** mode, this message disappears when the measured value is below the upper alarm limit.

- ① **EtN<sub>2</sub>O ALM LO**: used to adjust the lower alarm limit of EtN<sub>2</sub>O. When the measured value is smaller than EtN<sub>2</sub>O lower alarm limit, the **EtN<sub>2</sub>O LOW** message is displayed on the screen. In the **UNLATCH** mode, this message disappears when the measured value is above the lower alarm limit.
- ① **FiN<sub>2</sub>O ALM HI**: used to adjust the upper alarm limit of FiN<sub>2</sub>O. When the measured value is larger than FiN<sub>2</sub>O upper alarm limit, the **FiN<sub>2</sub>O HIGH** message is displayed on the screen. In **UNLATCH** mode, this message disappears when the measured value is below the upper alarm limit.
- ① **FiN<sub>2</sub>O ALM LO**: used to adjust the lower alarm limit of FiN<sub>2</sub>O. When the measured value is smaller than FiN<sub>2</sub>O lower alarm limit, the **FiN<sub>2</sub>O LOW** message is displayed on the screen. In the **UNLATCH** mode, this message disappears when the measured value is above the lower alarm limit.
- ① **EtAA ALM HI**: used to adjust the upper alarm limit of EtAA. When the measured value is larger than EtAA upper alarm limit, the **EtAA HIGH** message is displayed on the screen. In **UNLATCH** mode, this message disappears when the measured value is below the upper alarm limit.
- ① **EtAA ALM LO**: used to adjust the lower alarm limit of EtAA. When the measured value is smaller than EtAA lower alarm limit, the **EtAA LOW** message is displayed on the screen. In the **UNLATCH** mode, this message disappears when the measured value is above the lower alarm limit.
- ① **FiAA ALM HI**: used to adjust the upper alarm limit of FiAA. When the measured value is larger than FiAA upper alarm limit, the **FiAA HIGH** message is displayed on the screen. In **UNLATCH** mode, this message disappears when the measured value is below the upper alarm limit.
- ① **FiAA ALM LO**: used to adjust the lower alarm limit of FiAA. When the measured value is smaller than FiAA lower alarm limit, the **FiAA LOW** message is displayed on the screen. In the **UNLATCH** mode, this message disappears when the measured value is above the lower alarm limit.
- ① **APNEA ALM**: used to set up the apnea alarm time.

**NOTE:**

- 1 Never turn off **APNEA** alarm.
- 2 When various alarms happen together, the screen only displays the alarm message of the highest alarm level.

### 19.3.3 ADJUST WAVE SETUP

In the **GAS SETUP** menu, select **ADJUST WAVE AMP >>** item to pop up the **ADJUST WAVE SETUP** menu as shown in the figure below:

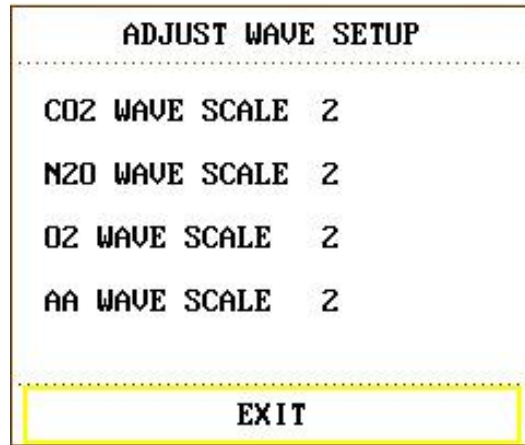

Figure 19-10 ADJUST WAVE SETUP Menu

- 👁️ **CO<sub>2</sub> WAVE SCALE:** used to adjust the display amplitude of CO<sub>2</sub> waveform
- 👁️ **N<sub>2</sub>O WAVE SCALE:** used to adjust the display amplitude of N<sub>2</sub>O waveform
- 👁️ **O<sub>2</sub> WAVE SCALE:** used to adjust the display amplitude of O<sub>2</sub> waveform
- 👁️ **AA WAVE SCALE:** used to adjust the display amplitude of AA waveform
- 👁️ **EXIT:** used to exit this menu.

### 19.3.4 DEFAULT menu

In the **GAS SETUP** menu, select **DEFAULT** item to pop up the **GAS DEFAULT CONFIG** menu as shown in the figure below:

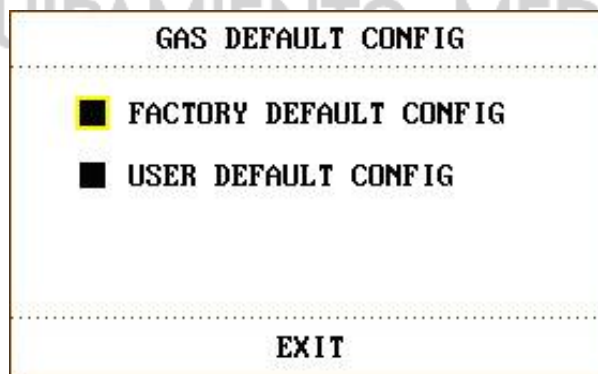

Figure 19-11 GAS DEFAULT CONFIG Menu

- 👁️ **FACTORY DEFAULT CONFIG:** used the factory default configuration to initialize menu items.
- 👁️ **USER DEFAULT CONFIG:** used the user default configuration to initialize menu items.
- 👁️ **EXIT:** used to exit this menu.

## 19.4 Alarm information and prompts

When the alarm record switch in a related menu is on, those physiological alarms caused by the parameter value exceeding the alarm limits will trigger the recorder to automatically output this parameter value and its related measured waveforms.

Physiological and technical alarms and prompts that may appear during GAS monitoring are listed in the following tables:

Physiological alarms:

Message	Cause	Alarm Level
FiCO <sub>2</sub> HIGH	The measured FiCO <sub>2</sub> value exceeds the set upper alarm limit.	User selectable
FiCO <sub>2</sub> LOW	The measured FiCO <sub>2</sub> value is below the set lower alarm limit.	User selectable
EtCO <sub>2</sub> HIGH	The measured EtCO <sub>2</sub> value exceeds the set upper alarm limit.	User selectable
EtCO <sub>2</sub> LOW	The measured EtCO <sub>2</sub> value is below the set lower alarm limit.	User selectable
FiO <sub>2</sub> HIGH	The measured FiO <sub>2</sub> value exceeds the set upper alarm limit.	User selectable
FiO <sub>2</sub> LOW	The measured FiO <sub>2</sub> value is below the set lower alarm limit.	User selectable
EtO <sub>2</sub> HIGH	The measured EtO <sub>2</sub> value exceeds the set upper alarm limit.	User selectable
EtO <sub>2</sub> LOW	The measured EtO <sub>2</sub> value is below the setup lower alarm limit.	User selectable
FiN <sub>2</sub> O HIGH	The measured FiN <sub>2</sub> O value exceeds the set upper alarm limit.	User selectable
FiN <sub>2</sub> O LOW	The measured FiN <sub>2</sub> O value is below the set lower alarm limit.	User selectable
EtN <sub>2</sub> O HIGH	The measured EtN <sub>2</sub> O value exceeds the set upper alarm limit.	User selectable
EtN <sub>2</sub> O LOW	The measured EtN <sub>2</sub> O value is below the set lower alarm limit.	User selectable



FiDES HIGH	The measured FiDES value exceeds the set upper alarm limit.	User selectable
FiDES LOW	The measured FiDES value is below the set lower alarm limit.	User selectable
EtDES HIGH	The measured EtDES value exceeds the set upper alarm limit.	User selectable
EtDES LOW	The measured EtDES value is below the set lower alarm limit.	User selectable
FiHAL HIGH	The measured FiHAL value exceeds the set upper alarm limit.	User selectable
FiHAL LOW	The measured FiHAL value is below the set lower alarm limit.	User selectable
EtHAL HIGH	The measured EtHAL value exceeds the set upper alarm limit.	User selectable
EtHAL LOW	The measured EtHAL value is below the set lower alarm limit.	User selectable
FiISO HIGH	The measured FiISO value exceeds the set upper alarm limit.	User selectable
FiISO LOW	The measured FiISO value is below the set lower alarm limit.	User selectable
EtISO HIGH	The measured EtISO value exceeds the set upper alarm limit.	User selectable
EtISO LOW	The measured EtISO value is below the set lower alarm limit.	User selectable
FiSEV HIGH	The measured FiSEV value exceeds the set upper alarm limit.	User selectable
FiSEV LOW	The measured FiSEV value is below the set lower alarm limit.	User selectable
EtSEV HIGH	The measured EtSEV value exceeds the set upper alarm limit.	User selectable
EtSEV LOW	The measured EtSEV value is below the set lower alarm limit.	User selectable

FiENF HIGH	The measured FiENF value exceeds the set upper alarm limit.	User selectable
FiENF LOW	The measured FiENF value is below the set lower alarm limit.	User selectable
EtENF HIGH	The measured EtENF value exceeds the set upper alarm limit.	User selectable
EtENF LOW	The measured EtENF value is below the set lower alarm limit.	User selectable
AwRR HIGH	The measured AwRR value exceeds the set upper alarm limit.	User selectable
AwRR LOW	The measured AwRR value is below the set lower alarm limit.	User selectable
GAS APNEA ALM	Respiration can not be detected during specified time interval	High

## Technical alarms:

Message	Cause	Alarm Level
AG WATERTRAP NO	The AG watertrap falls off from the monitor	Med
CHANGE WATERTRAP AG	Replace the AG watertrap	
AG WATERTRAP TYPE WRONG	The type of the AG watertrap being used is not suitable	
AG INIT FAIL	AG module has failure	High
AG COMM STOP	AG module failure or communication failure	
AG OCCLUSION	The actual PUMP rate of the AG module is <20ml/min, which exceeds 1 second	
AG COMM ERROR	AG module has communication failure	
AG HARDWARE ERROR	AG module has hardware failure	
AG DATA LIMIT ERROR	AG module failure	

AG USA ERROR	AG module failure	High
AG ZREF FAIL	AG module fails to zero	
AG CAL FAIL	AG module fails to calibrate	
AG NO OXYGEN SENSOR	The oxygen sensor falls off from the GAS module	Med
AG CHANGE OXYGEN SENSOR	Replace oxygen sensor of GAS module	Med

Prompt:

Message	Cause	Alarm Level
AG IS STARTING	Loading the GAS module	No alarm
AG WARM UP	GAS module is operating in the Warm-up status.	No alarm
AG STANDBY	GAS module is operating in the Standby status.	No alarm
AG IS ZEROING	GAS module is zero calibrating	No alarm

## 19.5 Maintenance and Cleaning

### 👁 GAS module

For detailed cleaning information about GAS Module, refer to *Chapter 11 Maintenance/Cleaning* in this user manual.

### 👁 Bacteria filter

The bacteria filter is one-off type, i.e., one bacteria filter can only be used by one patient.

### 👁 Sampling cannula

The sampling cannula is one-off type.

### 👁 Gas exhaust outlet

The gas exhaust outlet is reusable. You need to replace it only when it is damaged or becomes loosely connected. This tube can be cleaned and disinfected.

Cleaning: use cloth moistened with warm soap water to clean the tube. Do not immerse the tube into the liquid.

Disinfection: use cloth moistened with cool chemical disinfectant (ramification mainly containing aldehyde, ethanol or ramification mainly containing ethanol) to clean the tube. Do not immerse the tube into the liquid. After cleaning, use wet cloth to wipe off the disinfectant and then use dry cloth to wipe the tube.

## **👁 Occlusion handling**

If the GAS module passage is occluded, the screen will display the message **AG OCCLUSION**. The following are a few examples of occlusion, which you may remove one by one until this message disappears.

### **Entrance Occlusion**

If the part at the entrance, such as filter, sampling cannula or airway connector is occluded by condensed water, the screen will display the message telling that the airway is occluded.

The optimal method to remove clogs of this kind is:

Check for clogs in entrance parts:

- a. Replace the bacteria filter at the entrance.
- b. Check the sample pipe for clogs and/or entangle. If necessary, replace it.
- c. Check the airway connector for water. If necessary, drain off the water and install the connector again.

### **Internal Occlusion**

If the interior of the GAS Module is contaminated by condensed water, the screen will also display the message telling that the airway is occluded.

The optional method to remove clogs of this kind is:

Step 1: as usual, check the entrance or the exit for clogs and remove them.

Step 2: if occlusion still persists after step 1, you should consider the existence of interior occlusion. In this situation, contact the manufacturer.

## Chapter 20 Accessories and Ordering Information

### **WARNING**

The specification of accessories recommended is listed below. Using other accessories may damage the monitor.

The following accessories are recommended when using this monitor.

<b>Standard Accessories</b>	
12.01.109069	EDAN SH1 Adult Reusable SpO2 Sensor (Lemo)
11.57.40029	Adult Cuff /(25~35cm), CM1203
01.57.471005	NIBP Tube (3m) with Connector
01.57.040187	Skin Temperature Probe ( 10K )
01.57.040190	5-lead snap connector ECG cable(IEC standard)
11.57.40010	ECG Cable With 5-lead Wires (AHA Standard)/ CK-SMD780A
11.57.040159	Adult Disposable Adhesive Electrodes
11.57.040193	Adult Pediatric Disposable Adhesive Electrodes
01.13.36014	Power Cable(IEC Standard) 220V
11.13.36015	Power Cable(AHA Standard)
11.21.064116	Rechargeable Lithium-Ion Battery (14.8V, 4Ah)
11.21.064103	Rechargeable Lithium-Ion Battery (14.8V, 2Ah)
11.13.114214	Ground Cable
<b>Optional Accessories</b>	
<b>EDAN SpO<sub>2</sub></b>	
12.01.109069	EDAN SH1 Adult Reusable SpO2 Sensor (Lemo)
12.01.109079	EDAN SH1 Adult Reusable SpO2 Sensor (DB9)
01.13.110513	EDAN SpO2 Extension cable
01.13.210001	EDAN SpO2 Extension Cable(DB9 to Lemo, 2m, TPU)
12.01.110492	DAN SH3 Neonate Warp SpO2 Sensor (DB9)
12.01.110515	EDAN SH4 Adult Silicone Soft-tip SpO2 Sensor (DB9)
02.01.110531	EDAN SH4 Adult Silicone Soft-tip SpO2 Sensor (DB9) (Immersion Disinfection)
12.01.110521	EDAN SH5 Pediatric Silicone Soft-tip SpO2 Sensor ( DB9)

01.57.040196	Adult Disposable SpO2 Sensor
01.57.040197	Pediatric Disposable SpO2 Sensor
01.57.040198	Infant Disposable SpO2 Sensor
01.57.040199	Neonatal Disposable SpO2 Sensor
<b>NELLCOR</b>	
11.15.30043	Nellcor Reusable Adult SpO2 Sensor (DS-100A OxiMax) (Weak Perfusion Resistance)
11.15.40096	Nellcor Reusable Adult/Neonate SpO2 Sensor (OXI-A/N OxiMax)
11.13.30131-11	Nellcor SpO2 Extension Cable (Compatible with Nellcor OXI-Max SpO2 Module and Nellcor Sensor)
<b>NIBP</b>	
01.57.471005	NIBP Tube (3m) with Connector
01.59.36104	NIBP Tube (3m) with Connector
01.59.036118	NIBP Tube (3m) with Connector
01.59.36036	NIBP Tube (3m) with Connector
01.57.471021	Connecting Tube for Neonatal Cuff (Only Compatible with Neonatal Disposable and NIBP Tube)
01.57.040210	Large Adult Cuff /(33 ~ 47cm),CM1304
01.57.040205	Adult Cuff /(25~35cm), CM1303
01.57.040211	Pediatric Cuff /(18 ~ 26cm), CM1302
01.57.040212	Infant Cuff / (10-19cm), CM1301
11.57.40020	Infant Cuff / (10-19cm), CM1201
11.57.40018	Pediatric Cuff /(18 ~ 26cm), CM1202
11.57.40029	Adult Cuff /(25~35cm), CM1203
11.57.40074	Large Adult Cuff /(33 ~ 47cm),CM1204
11.57.40097	Neonatal Disposable Cuff /(6-9 cm),5102
11.57.40098	Neonatal Disposable Cuff /(9-14cm),5104
<b>TEMP</b>	
01.57.040185	Skin Temperature Probe ( 2.252K )
01.57.040187	Skin Temperature Probe ( 10K )
01.57.040184	Rectal / Oral Temperature Probe ( 2.252K )
01.57.040186	Rectal / Oral Temperature Probe ( 10K )
<b>ECG</b>	
01.57.041091-11	3-Lead Snap Connector ECG Cable (IEC Standard)

01.57.471001-11	3-Lead Clip Connector ECG Cable (IEC Standard)
01.57.471002-11	3-Lead Clip Connector ECG Cable (IEC, Defibrillation)
01.57.471003-11	5-Lead Clip Connector ECG Cable (IEC Standard)
01.57.471004-11	5-Lead Clip Connector ECG Cable (AHA Standard)
01.57.040190-11	5-Lead Snap Connector ECG Cable (IEC Standard)
01.57.101027-11	5-Lead Snap Connector ECG Cable (AHA, Defibrillation)
01.57.040182-11	5-Lead Snap Connector ECG Cable (AHA Standard)
01.57.109100-11	10-Lead ECG Trunk Cable (AHA, Defibrillation)
01.57.109101	10-Lead Snap ECG Limb Wires (AHA)
01.57.471029-10	3-Lead Snap Connector ECG Cable (AHA Standard)
01.57.471006	3-Lead Snap Connector ECG Cable(IEC Standard)
01.57.040206	5-Lead ECG Trunk Cable (IEC, Defibrillation)
01.57.040207	5-Lead Snap ECG Limb Wires (IEC)
01.57.040208	5-Lead Clip ECG Limb Wires (IEC)
01.57.471022	5-Lead ECG Trunk Cable (AHA, Defibrillation)
01.57.471023	5-Lead Snap ECG Limb Wires (AHA)
01.57.471024	3-Lead ECG Trunk Cable (IEC, Defibrillation)
01.57.471025	3-Lead Clip ECG Limb Wires (IEC)
01.57.471009	5-Lead Snap Connector ECG Cable (IEC)
01.57.040202-11	10-Lead ECG Trunk Cable (IEC, Defibrillation)
01.57.040203	10-Lead Snap ECG Limb Wires (IEC)
<b>CO<sub>2</sub></b>	
12.08.078137	Respironics EtCO <sub>2</sub> Module/ (Side-stream) 1022054
12.08.078166	LoFlo™ Module Mounting Bracket (Respironics 1027730)
11.57.078139	Disposable CO <sub>2</sub> Nasal Cannula - Adult (Respironics 3468ADU-00)
11.57.078140	Disposable CO <sub>2</sub> Nasal Cannula - Pediatric (Respironics 3468PED-00)
11.57.078141	Disposable CO <sub>2</sub> Nasal Cannula - Infant (Respironics 3468INF-00)
11.57.078154	Disposable Sampling Line Kit with Dehumidification Tubing (Respironics 3475-00)
11.15.040143	Respironics CAPNOSTAT 5 EtCO <sub>2</sub> (Main-stream) Module 1015928
11.59.078155	Disposable Adult Airway Adapter (6063-00)
11.59.078156	Disposable Neonatal (Infant/Pediatric) Airway Adapter (6312-00)

12.08.078138	Respironics EtCO2 Component/ (Side-stream) 1024956
11.57.078142	Adult Nasal CO2 with O2 Delivery Sampling Cannula
11.57.078143	Pediatric Nasal CO2 with O2 Delivery Sampling Cannula
11.57.078144	Infant Nasal CO2 with O2 Delivery Sampling Cannula
11.57.101019	Adult Nasal/Oral CO2 Sampling Cannula
11.57.101020	Pediatric Nasal/Oral CO2 Sampling Cannula
11.57.101021	Adult Nasal/Oral CO2 with O2 Delivery Sampling Cannula
01.12.031598	Adult/Pediatric Airway Adapter Kit
11.57.078151	Adult/Pediatric Airway Adapter Kit with Dehumidification Tubing
11.57.078152	Pediatric/Infant Airway Adapter Kit with Dehumidification Tubing
11.57.078158	Pediatric Mask /Mainstream 9960PED-00
11.57.078159	Adult Standard Mask /Mainstream 9960STD-00
11.57.078160	Adult Large Mask /Mainstream 9960STD-00
11.57.078161	Band /Mainstream 8751-00
11.12.078162	Card Slot /Mainstream 6934-00
<b>IBP</b>	
01.57.471014	Pressure Transducer Interface Cable
01.57.471013	Pressure Transducer Interface Cable
01.57.471027-10	Pressure Transducer Interface Cable
01.57.471028-10	Pressure Transducer Interface Cable
11.57.40121	Disposable Pressure Transducer Kit(BD DT-4812)
<b>CO</b>	
01.57.471012	Cardiac Output Cable
11.15.40119	In-line Injection Temperature Probe (BD 684056-SP4042)
11.15.40120	In-line Injection Temperature Probe Housing (BD 680006-SP5045)
11.57.100175	Control Syringe (Medex MA387)
<b>GAS</b>	
11.57.100217	DRYLINE™ Sampling Line, Adult (2.5m) (Artema 60-15200-00)
11.57.100218	DRYLINE™ Sampling Line, Neonate (2.5m) (Artema 60-15300-00)
11.12.031446	DRYLINE™ Airway Adapter, Straight (Artema 60-14100-00)



11.12.031447	DRYLINE™ Airway Adapter, Elbow (Artema 60-14200-00)
11.57.100214	DRYLINE™ Water Trap, Adult (Artema 60-13100-00)
11.15.040138	OXIMA™ Galvanic Oxygen Sensor (Artema 60-10351-00 )
11.57.100216	DRYLINE™ Water Trap, Neonate (Artema 60-13200-00)
<b>OTHERS</b>	
11.21.064116	Rechargeable Lithium-Ion Battery (14.8V, 4Ah)
11.21.064103	Rechargeable Lithium-Ion Battery (14.8V, 2Ah)
02.01.101207	ASUS Wireless AP (WL-330g EAP)
12.01.19084	Thermal Printer
01.57.78035	Printing Paper
11.21.64056	Vehicle-Carried Inverter
12.01.30493	Wall Mount (Simple)
02.01.30164	Wall Mount
02.01.101043	Basket (Only Compatible with Wall Mount MS3R-30164)
03.28.101952	Trolley (MT-207)
02.04.101976	Trolley Basket (in the Bottom)
11.18.078191	Flash Disk (PNY 2.0 2G USB)
11.13.114214	Ground Cable

## Chapter 21 Warranty and Service Policy

### 21.1 Warranty

EDAN warrants that EDAN's products meet the labeled specifications of the products and will be free from defects in materials and workmanship that occur within warranty period. The warranty period begins on the date the products are shipped to distributors.

The warranty is void in cases of:

- a) damage caused by handling during shipping.
- b) subsequent damage caused by improper use or maintenance.
- c) damage caused by alteration or repair by anyone not authorized by EDAN.
- d) damage caused by accidents.
- e) replacement or removal of serial number label and manufacture label.

If a product covered by this warranty is determined to be defective because of defective materials, components, or workmanship, and the warranty claim is made within the warranty period, EDAN will, at its discretion, repair or replace the defective part(s) free of charge. EDAN will not provide a substitute product for use when the defective product is being repaired.

### 21.2 Service Policy

All repairs on products must be performed or approved by EDAN. Unauthorized repairs will void the warranty. In addition, whether or not covered under warranty, any product repair shall be exclusively be performed by EDAN certified service personnel.

If the product fails to function properly-or if you need assistance, service, or spare parts-contact EDAN's service center. A representative will assist you troubleshooting the problem and will make every effort to solve it over the phone or Email, avoiding potential unnecessary returns.

In case a return can not be avoided, the representative will record all necessary information and will provide a Return Material Authorization (RMA) form that includes the appropriate return address and instructions. An RMA form must be obtained prior to any return.

#### ***Freight policy:***

Under warranty: the service claimer is responsible for freight & insurance charges when a return is shipped to EDAN for service including custom charges. EDAN is responsible for freight, insurance & custom charges from EDAN to service claimer.

Out of warranty: the service claimer is responsible for any freight, insurance & custom charges for product.

#### ***Contact information:***

If you have any question about maintenance, technical specifications or malfunctions of devices, contact your local distributor.

Alternatively, you can send an email to EDAN service department at: [support@edan.com.cn](mailto:support@edan.com.cn)

## Appendix I Specifications

### A1.1 Classification

Anti-electroshock Type	Class I equipment and internal powered equipment
EMC Type	Class A
Anti-electroshock Degree	ECG (RESP), TEMP, IBP, CO CF SpO <sub>2</sub> , NIBP, CO <sub>2</sub> , GAS BF
Ingress Protection	IPX1
Disinfection/Sterilizing method	Refer to <i>Chapter 12 ~ Chapter 19</i> for details.
Working System	Continuous running equipment
Compliant with Safety Standards	IEC60601-1:1988+A1+A2, EN60601-1:1990+A1+A2, IEC/EN60601-1-2:2001+A1, IEC/EN60601-2-27, IEC/EN60601-2-30, ISO9919, IEC/EN60601-2-34, IEC/EN60601-2-49, ISO21647, GB9706.1-2007, GB9706.25-2005, YY1079-2008, YY0670-2008, YY0667-2008, IEC/EN 60601-2-25 AAMI/ANSI EC11

### A1.2 Specifications

#### A1.2.1 Size and Weight

Weight	5 kg
--------	------

#### A1.2.2 Environment

Temperature	
Working	+5°C ~ +40°C
Transport and Storage	-20°C ~ +55°C
Humidity	
Working	25% ~ 80% (no coagulate)
Transport and Storage	25% ~ 93% (no coagulate)

Altitude	
Working	860hPa ~ 1060hPa
Transport and Storage	700hPa ~ 1060hPa
Power Supply	100V-240V~, 50Hz/60Hz Pmax=80VA FUSE T 1.6AL

### A1.2.3 Display

Display Screen	10.1 inch /10.4 inch /12.1 inch, multicolour TFT LCD, 10.1-inch: Resolution 800×480; 10.4-inch /12.1-inch: Resolution 800×600.
Messages	A maximum of 13 waveforms One power LED (Green) One alarm LED (Yellow/Red) One charge LED (Yellow/ Green) Three indicator modes corresponding to alarm mode.

### A1.2.4 Battery

Capacitance	2.2 Ah/4.2Ah
Voltage	14.8 V DC
Typical Working Period	2.2Ah 80 min 4.2Ah 180 min (At 25°C; in continual SpO <sub>2</sub> measuring mode and NIBP automatic measuring mode with the operating interval of 15 minutes; the recording interval of 10 minutes.)
Rechargeable Period	2.2Ah 150 min 4.2Ah 360 min (Monitor is on or in standby mode.)

### A1.2.5 Recorder (Optional)

Record Width	48 mm
Paper Speed	25 mm/s, 50 mm/s
Trace	1 /2/ 3 optional
Recording Types	Continuous real-time recording 8 second real-time recording Auto interval recording Parameter alarm recording Trend recording Titration table recording Frozen waveform recording

### A1.2.6 Recall

Trend Recall	
Short	1 hrs, 1-second resolution
Long	96 hrs, 1-min. resolution
Recall	500 sets NIBP measurement data
	50 sets 12-lead ECG diagnosis results

### A1.2.7 ECG

Lead Mode	3-Lead: I, II, III 5-Lead: I, II, III, aVR, aVL, aVF, V 12-Lead: I, II, III, aVR, aVL, aVF, V1, V2, V3, V4, V5, V6
Lead Naming Style	AHA, IEC
Bandwidth (-3dB)	Diagnosis: 0.05Hz ~ 150Hz Monitor: 0.5Hz ~ 40Hz Surgery: 1Hz ~ 20Hz

CMRR (Common Mode Rejection Ratio)	Diagnosis: >95dB (the Notch filter is off) Monitor: >105dB (the Notch filter is on) Surgery: >105dB (the Notch filter is on)
Notch	In diagnosis, monitor and surgery modes: 50Hz/60Hz (Notch filter can be turned on or off manually)
Differential Input Impedance	>5M
Input Signal Range	±8mV PP
Accuracy of Input Signal Reconstruction	The total error and frequency response comply with the ANSI/AAMI EC13:2002 Sect. 4.2.9.8
Electrode Offset Potential Tolerance	±500mV
Auxiliary Current (Leads off Detection)	Active electrode: <100nA Reference electrode: <900nA
Input Offset Current	0.1µA
Recovery Time after Defibrillation	<5s
Leakage Current of Patient	<10µA (in normal status)
Scale Signal	1mVPP; accuracy: ±5%
System Noise	<30µVPP
ESU Protection	Incision mode: 300W Congelation mode: 100W Restore time: 10s It complies with ANSI/AAMI EC13-2002: Sect. 4.1.2.1 a).
Noise Suppression of Electrotome	It is tested according to the test method in EC13: 2002 Sect.5.2.9.14, and it complies with ANSI/AAMI EC13:2002 Sect. 4.2.9.14.
Pace Pulse	
Pulse Indicator	It complies with ANSI/AAMI EC13:2002 Sect.4.1.4.1.

	<p>PACE pulses meeting the following conditions are marked by the PACE indicator:</p> <p>Amplitude: <math>\pm 2</math> mV ~ <math>\pm 700</math> mV</p> <p>Width: 0.1 ms ~ 2 ms</p> <p>Ascending time: 10 <math>\mu</math>s ~ 100 <math>\mu</math>s</p>
Pulse Rejection	<p>It complies with ANSI/AAMI EC13-2002: Sect. 4.1.4.1. Pulse is rejected if it meets the following conditions:</p> <p>Amplitude: <math>\pm 2</math> mV ~ <math>\pm 700</math> mV</p> <p>Width: 0.1 ms ~ 2 ms</p> <p>Ascending time: 10 <math>\mu</math>s ~ 100 <math>\mu</math>s</p>
<b>Heart Rate</b>	
HR Calculation	
Range	<p>ADU: 15 bpm ~ 300 bpm</p> <p>PED/NEO: 15 bpm ~ 350 bpm</p>
Accuracy	$\pm 1\%$ or $\pm 1$ bpm, between which the bigger is preferred.
Resolution	1 bpm
Sensibility	300 $\mu$ VPP
PVC	
Range	<p>ADU: 0~300 PVCs/ min</p> <p>PED/NEO: 0~350 PVCs/ min</p>
Resolution	1 PVCs/min
ST Value	
Range	-2.0 mV ~ +2.0 mV
Accuracy	The max. of $\pm 0.02$ mV or 10% (-0.8 mV ~ +0.8 mV); other ranges are undedfined.
Resolution	0.01 mV
HR Averaging Method	
Method 1	Normally, heart rate is computed by averaging the 12

	latest RR intervals.
Method 2	If each of three consecutive RR intervals is greater than 1200ms, then the four latest RR intervals are averaged to compute the HR.
Range of Sinus and SV Rhythm	
Brady	ADU: 120 bpm ~ 300 bpm PED/NEO: 160 bpm ~ 350 bpm
Normal	ADU: 41 bpm ~ 119 bpm PED/NEO: 61 bpm ~159 bpm
Tachy	ADU: 15 bpm ~ 40 bpm PED/NEO: 15 bpm ~ 60 bpm
Range of Ventricular Rhythm	
Ventricular Tachycardia	The interval of 5 consecutive ventricular wave is less than 600 ms
Ventricular Rhythm	The interval of consecutive ventricular wave ranges from 600 ms to 1000 ms
Ventricular Bradycardia	The interval of 5 consecutive ventricular wave is more than 1000 ms
Startup Time for Tachycardia	
Ventricular Tachycardia 1 mV 206bpm	Gain 1.0: 5 s Gain 0.5: 15 s Gain 2.0: 4 s
Ventricular Tachycardia 2 mV 195bpm	Gain 1.0: 3 s Gain 0.5: 6 s Gain 2.0: 3 s
Response Time of Heart Rate Meter to Change in HR	HR range: 80 bpm ~ 120 bpm Range : 7s ~ 8s, average is 7.5s HR range: 80bpm ~ 40bpm Range : 7s ~ 8s, average is 7.5s



Tall T-wave Rejection	Exceeds ANSI/AAMI EC13-2002 Sect. 4.1.2.1 c) minimum recommended 1.2mV T-Wave amplitude		
Accuracy of Heart Rate Meter and Response to Irregular Rhythm	According with ANSI/AAMI EC13-2002 Sect.4.1.2.1 e) The HR value displays after a stable period of 20s: Ventricular bigeminy: 80bpm±1bpm Slow alternating ventricular bigeminy: 60bpm±1bpm Rapid alternating ventricular bigeminy: 120bpm±1bpm Bidirectional systoles: 91bpm±1bpm		
ARR Analysis (with the results of 16 types)	Patients without pacemaker		Patients with pacemaker
	ASYSTOLE	R on T	ASYSTOLE
	VFIB/VTAC	PVC	TACHY
	COUPLET	TACHY	BRADY
	VT>2	BRADY	PNC
	BIGEMINY	MISSED BEATS	PNP
	TRIGEMINY	IRR	
	VENT	VBRADY	
12-lead ECG Synchronization Analysis	Average parameters of heart beat		
	Heart rate (bpm)		
	Time limit of P wave (ms)		
	PR interval (ms)		
	QRS interval (ms)		
	QT/QTc (ms)		
	P-QRS-T AXIS		

**A1.2.8 RESP**

Method	Impedance between R-F (RA-LL), R-L (RA-LA)
Lead	Lead I/ Lead II (Lead II by default)
Measuring Sensitivity	200~4500 baseline impedance: 0.3
Base Line Impedance Range	200 ~ 2500 (using leads cables with no resistance)
	2200 ~ 4500 (using leads cables with 1K resistance)
Differential Input Impedance	>2.5M
Waveform Bandwidth	0.2Hz ~ 2.5Hz (-3dB)
RR Measuring and Alarm Range:	
Adult	0 rpm ~120rpm
Neo/ Pediatric	0 rpm ~150rpm
Resolution	1 rpm
Accuracy	±2 rpm
Time Settings for APNEA Alarm	10s, 15s, 20s, 25s, 30s, 35s, 40s

**A1.2.9 NIBP****V6 Module**

Method	Oscillometric
Mode	Manual, Auto, Continuous
Measuring Interval in AUTO Mode	1/2/3/4/5/10/15/30/60/90/120/240/480 min
Continuous	5min, interval is 5s
Measuring Type	SYS, DIA, MAP, PR
Measuring Rang	

Adult Mode	SYS: 40 mmHg ~ 270 mmHg DIA: 10 mmHg ~ 215 mmHg MAP: 20 mmHg ~ 235 mmHg
Pediatric Mode	SYS: 40 mmHg ~ 200 mmHg DIA: 10 mmHg ~ 150 mmHg MAP: 20 mmHg ~ 165 mmHg
Neonatal Mode	SYS: 40 mmHg ~ 135 mmHg DIA: 10 mmHg ~ 100 mmHg MAP: 20 mmHg ~ 110 mmHg
Alarm Type	SYS, DIA, MAP
Cuff Pressure Measuring Range	0 mmHg ~ 290 mmHg
Pressure Resolution	1mmHg
Maximum Mean Error	±5mmHg
Maximum Standard Deviation	8mmHg
Maximum Measuring Period	
Adult/ Pediatric	120s
Neonatal	90s
Typical Measuring Period	30s ~ 45s (depend on HR/motion disturbance)
Overpressure Protection (Dual Overpressure Protection)	
Adult	297±3mmHg
Pediatric	240±3mmHg
Neonatal	145±3mmHg

**M3600 Module**

Method	Oscillometric
Mode	Manual, Auto, Continuous

Measuring Interval in AUTO Mode	1/2/3/4/5/10/15/30/60/90 min, 2/4/8h
PR Range	Adult/ Pediatric mode: 40bpm ~ 200bpm
	Neonatal mode: 40 bpm ~ 240bpm
PR Accuracy	$\pm 2$ bpm or 2% of the readings
Measuring Type	SYS, DIA, MAP
Measuring Rang	
Adult Mode	SYS: 60 mmHg ~ 250 mmHg DIA: 40 mmHg ~ 200 mmHg MAP: 45 mmHg ~ 235 mmHg
Neonatal Mode	SYS: 40 mmHg ~ 120 mmHg DIA: 20 mmHg ~ 90 mmHg MAP: 30 mmHg ~ 100 mmHg
Alarm Type	SYS, DIA, MAP
Cuff Pressure Measuring Range	0 mmHg ~ 300 mmHg
Pressure Resolution	1mmHg
Measuring Accuracy	
Maximum Mean Error	$\pm 5$ mmHg
Maximum Standard Deviation	8mmHg

### A1.2.10 SpO<sub>2</sub>

Measuring Range	0 % ~ 100 %
Alarm Range	0 % ~ 100 %
Resolution	1 %
Accuracy	
Adult (including Pediatric)	$\pm 2\%$ (70%~100% SpO <sub>2</sub> )

	Undefined (0% ~ 69% SpO <sub>2</sub> )
Neonatal	±3% (70%~100% SpO <sub>2</sub> )
	Undefined (0% ~ 69% SpO <sub>2</sub> )
<b>Pulse Rate</b>	
Measuring Range	25bpm ~ 300bpm
Alarm Range	30bpm ~ 300bpm
Resolution	1bpm
Accuracy	±2bpm
Data Update Period	1s
<b>Nellcor module (optional)</b>	
Measuring Range	1% ~ 100 %
Alarm Range	1% ~ 100 %
Resolution	1 %
<b>Accuracy</b>	
Adult and Low-perfusion	±2 digits (70%~100% SpO <sub>2</sub> )
	Undefined (0~69% SpO <sub>2</sub> )
Neonate	±3 digits (70%~100% SpO <sub>2</sub> )
	Undefined (0~69% SpO <sub>2</sub> )
<b>Pulse Rate</b>	
Measuring and Alarm Range	20bpm ~250bpm
Resolution	1bpm
Accuracy	±3bpm

### A1.2.11 TEMP

Channel	2
---------	---

Measuring Range	0 °C ~ +50 °C
Sensor Type	YSI-10K and YSI-2.252K
Measuring and Alarm Range	0°C ~ +50 °C
Resolution	+0.1°C
Accuracy	±0.1°C ( Not including error of the sensor)
Refresh Time	Every 1s ~ 2s

### A1.2.12 IBP (Optional)

Channel	2
Label	ART, PA, CVP, RAP, LAP, ICP, P1, P2
Pressure Sensor	
Sensitivity	5 (µV/V/mmHg)
Impedance	300 ~ 3000
Static Pressure Measuring Range	-50 mmHg ~ +300 mmHg
Static Pressure Accuracy	±2 % or 1mmHg, between which the bigger is preferred
Dynamical Pressure Measuring Range	-50 mmHg ~ +300 mmHg
Dynamical Pressure Accuracy	±2 % or 1mmHg, between which the bigger is preferred
Frequency Response	d.c. ~ 12.5Hz or 40Hz
Measuring and Alarm Range	
ART	0 mmHg ~ 300 mmHg
PA	-6 mmHg ~ 120mmHg
CVP/RAP/LAP/ICP	-10 mmHg ~ 40 mmHg
P1/P2	-50 mmHg ~ 300mmHg
Resolution	1 mmHg

Zero Range	$\pm 200$ mmHg
------------	----------------

### A1.2.13 CO<sub>2</sub> (Optional)

#### C5

Applicable Patient Type	Adult, pediatric and neonatal patients	
Method	Infra-red Absorption Technique	
Unit	mmHg/ %/ kPa	
Measuring Range		
CO <sub>2</sub>	EtCO <sub>2</sub>	0 mmHg ~ 150 mmHg
	FiCO <sub>2</sub>	3~50
	AwRR	2 ~ 150 rpm (Side stream) 0~150 rpm (Main stream)
Resolution	EtCO <sub>2</sub>	1 mmHg
	FiCO <sub>2</sub>	1mmHg
	AwRR	1rpm
Measuring Accuracy		
EtCO <sub>2</sub>	$\pm 2$ mmHg, 0 mmHg ~ 40 mmHg	
	Reading $\pm 5\%$ , 41 mmHg ~ 70 mmHg	
	Reading $\pm 8\%$ , 71 mmHg ~ 100 mmHg	
	Reading $\pm 10\%$ , 101 mmHg ~ 150 mmHg	
AwRR	$\pm 1$ rpm	
Sample Gas Flow Rate	50ml/min	
Stability		
Short Term Drift	Drift over 4 hours < 0.8 mmHg	
Long Term Drift	Accuracy for 120 hours	
O <sub>2</sub> Compensation		
Range	0 ~ 100%	

Resolution	1%
Default	16%
Alarm	EtCO <sub>2</sub> , FiCO <sub>2</sub> and AwRR alarm
Suffocation Alarm Delay	10, 15, 20, 25, 30, 35, 40s; 20s by default

**KM7002**

Method	Infra-red Absorption Technique
CO <sub>2</sub> Measuring Range	0-13% (0 ~ 100mmHg)
CO <sub>2</sub> Measuring Accuracy	< 5.0% CO <sub>2</sub> : ± 2 mmHg > 5.0% CO <sub>2</sub> :< 6% of the readings
PR	3 BPM ~ 150 BPM
PR Measuring Accuracy	1% or ±1BPM
Sample Gas Flow Rate	100ml/min ~ 200ml/min
Time for Warming up	Reach to 97% of the design deviation within 45s and to the design deviation within 10min.
Response Time (t10-90 %)	Approximately 100ms (120 ml/min of adult water tray, 1.5 meters of sampling cannula)
Delay	<3sec (120 ml/min of adult water tray, 1.5 meters of sampling cannula)

**A1.2.14 CO (Optional)**

Method	Thermodilution Technique
Measuring range	
CO	0.1 L/min ~ 20L/min
TB	+23°C ~ +43 °C
TI	-1°C ~ +27°C
Resolution	



CO	0.1L/min
TB, TI	0.1°C
TB Alarm Range	+23°C ~ +43 °C
Accuracy	
CO	±5% or ± 0.2 L/min, between which the bigger is preferred
TB	±0.1°C
TI	±0.1°C
Output Parameters	CO
	Hemodynamic Calculation

### A1.2.15 GAS (Optional)

Technology	Infra-red absorption characteristic
Updating Frequency	Once per second
Calibrate	Once per year
Ascending Time(10 % ~ 90 %)	Sampling gas flow: 120ml/min CO2                      250ms (descending time: 200ms) N2O                        250ms O2                            600ms Hal, Iso, Sev, Des    350ms
	Sampling gas flow: 200ml/min CO2                      250ms (descending time: 200ms) N2O                        250ms O2                            500ms Hal, Iso, Sev, Des    300ms Enf                         350ms
Max Delay	<4s
Measuring Range	

CO <sub>2</sub>	0 ~ 10 %	
O <sub>2</sub>	0 ~ 100 %	
N <sub>2</sub> O	0 ~ 100 %	
AwRR	2 rmp ~ 100 rmp	
Halothame	0 ~ 5 %	
Isoflurane	0 ~ 5 %	
Enflurane	0 ~ 5 %	
Sevoflurane	0 ~ 8 %	
Desflurane	0 ~ 18 %	
Accuracy		
<b>Gas</b>	<b>Concentration[%REL]</b>	<b>Inaccuracy [%ABS]</b>
CO <sub>2</sub>	0~1	±0.1
	1~5	±0.2
	5~7	±0.3
	7~10	±0.5
	>10	Unspecified
N <sub>2</sub> O	0~20	±2
	20~100	±3
O <sub>2</sub>	0~25	±1
	25~80	±2
	80~100	±3
HAL, ENF, ISO	0~1	±0.15
	1~5	±0.2
	>5	Unspecified
SEV	0~1	±0.15
	1~5	±0.2
	5~8	±0.4
	>8	Unspecified

DES	0 ~ 1	$\pm 0.15$
	1 ~ 5	$\pm 0.2$
	5 ~ 10	$\pm 0.4$
	10 ~ 15	$\pm 0.6$
	15 ~ 18	$\pm 1$
	>18	Unspecified



## Appendix II EMC Information

### - Guidance and Manufacture's Declaration

#### A2.1 Electromagnetic Emissions - for all EQUIPMENT and SYSTEMS

<b>Guidance and manufacture's declaration – electromagnetic emission</b>		
The monitor is intended for use in the electromagnetic environment specified below. The customer or the user of the monitor should assure that it is used in such an environment.		
<b>Emission test</b>	<b>Compliance</b>	<b>Electromagnetic environment – guidance</b>
RF emissions CISPR 11	Group 1	The monitor uses RF energy only for its internal function. Therefore, its RF emissions are very low and are not likely to cause any interference in nearby electronic equipment.
RF emission CISPR 11	Class A	The monitor is suitable for use in all establishments, other than domestic establishments and those directly connected to the public low-voltage power supply network that supplies buildings used for domestic purposes.
Harmonic emissions IEC/EN 61000-3-2	Class A	
Voltage fluctuations/ flicker emissions IEC/EN 61000-3-3	Complies	

#### A2.2 Electromagnetic Immunity - for all EQUIPMENT and SYSTEMS

<b>Guidance and manufacture's declaration – electromagnetic immunity</b>			
The monitor is intended for use in the electromagnetic environment specified below. The customer or the user of the monitor should assure that it is used in such an environment.			
<b>Immunity test</b>	<b>IEC/EN 60601 test level</b>	<b>Compliance level</b>	<b>Electromagnetic environment - guidance</b>
Electrostatic discharge (ESD) IEC/EN 61000-4-2	±6 kV contact ±8 kV air	±6 kV contact ±8 kV air	Floors should be wood, concrete or ceramic tile. If floor are covered with synthetic material, the relative humidity should be at least 30%.

Electrical fast transient/burst IEC/EN 61000-4-4	$\pm 2$ kV for power supply lines	$\pm 1$ kV for power supply lines	Mains power quality should be that of a typical commercial or hospital environment.
Surge IEC/EN 61000-4-5	$\pm 1$ kV differential mode $\pm 2$ kV common mode	$\pm 1$ kV differential mode $\pm 2$ kV common mode	Mains power quality should be that of a typical commercial or hospital environment.
Power frequency (50/60Hz) magnetic field IEC/EN 61000-4-8	3A/m	3A/m	Power frequency magnetic fields should be at levels characteristic of a typical location in a typical commercial or hospital environment.
Voltage dips, short interruptions and voltage variations on power supply input lines IEC/EN 61000-4-11	$< 5\% U_T$ ( $> 95\%$ dip in $U_T$ ) for 0.5 cycle $40\% U_T$ ( $60\%$ dip in $U_T$ ) for 5 cycles  $70\% U_T$ ( $30\%$ dip in $U_T$ ) for 25 cycles  $< 5\% U_T$ ( $> 95\%$ dip in $U_T$ ) for 5 sec	$< 5\% U_T$ ( $> 95\%$ dip in $U_T$ ) for 0.5 cycle $40\% U_T$ ( $60\%$ dip in $U_T$ ) for 5 cycles  $70\% U_T$ ( $30\%$ dip in $U_T$ ) for 25 cycles  $< 5\% U_T$ ( $> 95\%$ dip in $U_T$ ) for 5 sec	Mains power quality should be that of a typical commercial or hospital environment. If the user of the Patient Monitor requires continued operation during power mains interruptions, it is recommended that the Patient Monitor be powered from an uninterruptible power supply or a battery.
<b>NOTE</b> $U_T$ is the a.c. mains voltage prior to application of the test level.			

## A2.3 Electromagnetic Immunity - for EQUIPMENT and SYSTEMS that are not LIFE-SUPPORTING

Guidance and manufacture’s declaration – electromagnetic immunity			
The Patient Monitor is intended for use in the electromagnetic environment specified below. The customer or the user of Patient Monitor should assure that it is used in such an environment.			
Immunity test	IEC/EN 60601 test level	Compliance level	Electromagnetic environment - guidance
Conducted RF IEC/EN 61000-4-6	3 V <sub>rms</sub> 150 kHz to 80 MHz	3 V <sub>rms</sub>	<p>Portable and mobile RF communications equipment should be used no closer to any part of the Patient Monitor, including cables, than the recommended separation distance calculated from the equation applicable to the frequency of the transmitter.</p> <p><b>Recommended separation distance</b></p> $d = \sqrt{\frac{3.5}{V_1 f} P}$ $d = \sqrt{\frac{3.5}{E_1 f} P}$ <p>80 MHz to 800 MHz</p> $d = \sqrt{\frac{7}{E_1 f} P}$ <p>800 MHz to 2.5 GHz</p> <p>Where P is the maximum output power rating of the transmitter in watts (W) according to the transmitter manufacturer and d is the recommended separation distance in metres (m).</p> <p>Field strengths from fixed RF transmitters, as determined by an electromagnetic site survey,<sup>a</sup> should be less than the compliance level in each frequency range.<sup>b</sup></p> <p>Interference may occur in the vicinity of equipment marked with the following symbol:</p> 
Radiated RF IEC/EN 61000-4-3	3 V/m 80 MHz to 2.5 GHz	3 V/m	

**NOTE 1** At 80 MHz and 800 MHz, the higher frequency range applies.

**NOTE 2** These guidelines may not apply in all situations. Electromagnetic propagation is affected by absorption and reflection from structures, objects and people.

<sup>a</sup> Field strengths from fixed transmitters, such as base stations for radio (cellular/cordless) telephones and land mobile radios, amateur radio, AM and FM radio broadcast and TV broadcast cannot be predicted theoretically with accuracy. To assess the electromagnetic environment due to fixed RF transmitters, an electromagnetic site survey should be considered. If the measured field strength in the location in which the Patient Monitor is used exceeds the applicable RF compliance level above, the Patient Monitor should be observed to verify normal operation. If abnormal performance is observed, additional measures may be necessary, such as reorienting or relocating the Patient Monitor.

<sup>b</sup> Over the frequency range 150kHz to 80MHz, field strengths should be less than 3V/m.

## A2.4 Recommended Separation Distances

<b>Recommended separation distances between portable and mobile RF communications equipment and the monitor</b>			
The monitor is intended for use in an electromagnetic environment in which radiated RF disturbances are controlled. The customer or the user of the monitor can help prevent electromagnetic interference by maintaining a minimum distance between portable and mobile RF communications equipment (transmitters) and the monitor as recommended below, according to the maximum output power of the communications equipment.			
<b>Rated maximum output power of transmitter (W)</b>	<b>Separation distance according to frequency of transmitter(m)</b>		
	<b>150 kHz to 80 MHz</b>	<b>80 MHz to 800 MHz</b>	<b>800 MHz to 2.5 GHz</b>
	$d = \frac{\sqrt{3.5}}{\sqrt{E_{1f}}} \sqrt{P}$	$d = \frac{\sqrt{3.5}}{\sqrt{E_{1f}}} \sqrt{P}$	$d = \frac{\sqrt{7}}{\sqrt{E_{1f}}} \sqrt{P}$
0.01	<b>0.1167</b>	<b>0.1167</b>	<b>0.2334</b>
0.1	<b>0.3689</b>	<b>0.3689</b>	<b>0.7378</b>
1	<b>1.1667</b>	<b>1.1667</b>	<b>2.3334</b>
10	<b>3.6893</b>	<b>3.6893</b>	<b>7.3786</b>
100	<b>11.6667</b>	<b>11.6667</b>	<b>23.3334</b>
For transmitters rated at a maximum output power not listed above, the recommended separation distance d in metres (m) can be estimated using the equation applicable to the frequency of the transmitter, where P is the maximum output power rating of the transmitter in watts (W) according to the transmitter manufacturer.			
<b>NOTE 1</b> At 80 MHz and 800 MHz, the separation distance for the higher frequency range applies.			
<b>NOTE 2</b> These guidelines may not apply in all situations. Electromagnetic propagation is affected by absorption and reflection from structures, objects and people.			

P/N: 01.54.100231-19

**EDAN**  
www.edan.com.cn

EC REPRESENTATIVE

Shanghai International Trading Corp. GmbH (Hamburg)

Eiffestrasse 80, D-20537 Hamburg Germany

TEL: +49-40-2513175 FAX: +49-40-255726

E-mail: antonjin@yahoo.com.cn

EDAN INSTRUMENTS, INC.

3/F-B, Nanshan Medical Equipment Park, Nanhai Rd 1019#,

Shekou, Nanshan Shenzhen, 518067 P.R. CHINA

Email: info@edan.com.cn

TEL: +86-755-2689 8326 FAX: +86-755-2689 8330